

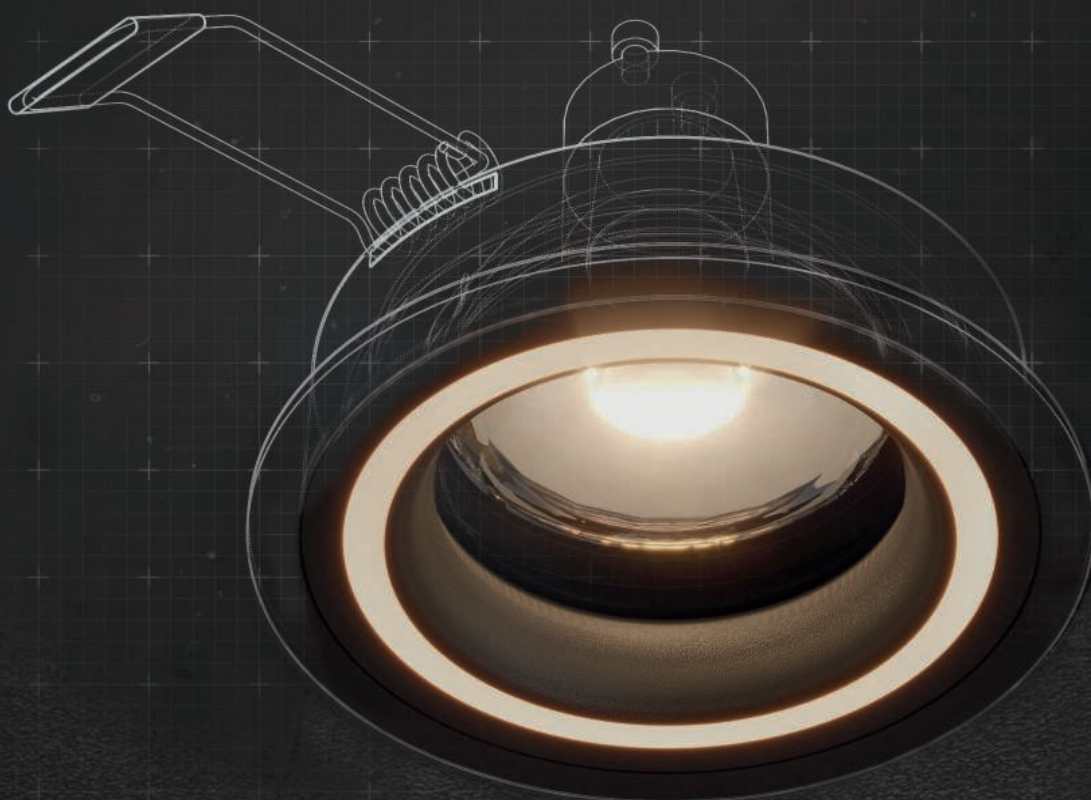

EGLO
my light | my style



2022/23

TECHNICAL LIGHT SOLUTIONS

TECHNISCHE LICHTLÖSUNGEN
SOLUTIONS D'ÉCLAIRAGE TECHNIQUE



Dear reader,

welcome to our extensive range of technical lighting systems. The hallmarks of this range are sleek shapes and minimalist designs paired with superb illumination and a broad range of user-friendly controls along with many other features you'll love.

This year we are creating flexible lighting design in living spaces with our track systems, and our LED panels impress not only with their good room illumination but also with their homely character.

Liebe Leserin, lieber Leser,

auf den folgenden Seiten erwartet Sie unser umfangreiches Sortiment an technischen Lichtlösungen. Schlanke Bauformen, reduzierte Designs sowie gute Ausleuchtung sind neben den unterschiedlichen und praktischen Steuerungsmöglichkeiten nur ein Teil der Eigenschaften, die dieses Sortiment ausmachen.

Auch in diesem Jahr schaffen wir mit unseren Schienensystemen eine flexible Lichtgestaltung in Wohnräumen und unsere LED-Panels bestechen neben ihrer guten Raumausleuchtung durch ihren wohnlichen Charakter.

Chère lectrice, cher lecteur,







Dans les pages suivantes, vous trouverez notre vaste gamme de solutions d'éclairage technique. Outre ses différentes options de commande très pratiques, cette gamme se caractérise aussi par des formes élancées, des designs minimalistes et une bonne qualité d'éclairage.

Cette année, nous créons une conception d'éclairage flexible dans les espaces de vie avec nos systèmes de rails, et nos panneaux LED impressionnent non seulement par leur bon éclairage de la pièce mais aussi par leur caractère accueillant.



CONTENT

INHALT
CONTENU

	EGLO CONNECT.Z	4-51
	EGLO ACCESS	52-63
	EGLO TRACK SYSTEM EGLO SCHIENENSYSTEM SYSTÈMES DE RAIL EGLO BASIC PRO	64-91
	LED PANEL LUMINAIRES LED PANEELLEUCHTEN LUMINAIRES LAMBRIS LED WITH FRAME FRAMELESS DECORATIVE WOOD FRAME	92-145
	DOWNLIGHTS EIN- & AUFBAULEUCHTEN LUMINAIRES ENCASTRÉS ET DE SURFACE RECESSED DOWNLIGHTS - HIGH VOLTAGE - LOW VOLTAGE - WITH SOCKET - FUEVA SURFACE DOWNLIGHTS - FUEVA - DECORATIVE	146-283
	LED STRIPE SOLUTIONS LED STRIPES - COB STRIPES - FLEXIBLE STRIPES LED PROFILES	284-339
	LEGEND & REGISTER	340-352

connect.2



zigbee



Bluetooth®

Discover the smart world





OVERVIEW



CONNECT Z
p. 15



SALICETO-Z
p. 17



TELIBELA-Z
p. 18-19



PADROGIANO-Z
p. 20-22



TURCONA-Z
p. 24



HERRORA-Z
p. 26



TURCONA-Z
p. 28-29



SALOBRENA-Z
p. 30-33



FUEVA-Z
p. 34-45



ROVITO-Z
p. 46-49



LED STRIPE-Z
p. 50-51



This product is available in different colors and shapes./ Dieser Artikel ist in unterschiedlichen Farben und Formen verfügbar.
Cet article est disponible en différentes couleurs et formes.

connect.z combines two control technologies in one system

connect.z vereint zwei Steuerungstechnologien in einem System

connect.z réunit deux technologies de commande au sein d'un même système



ZigBee is far and away the most widely used standard in the smart home world.

ZigBee ist der am weitesten verbreitete Standard in der Smart Home Welt.

ZigBee est le protocole le plus répandu au monde dans le domaine du Smart Home.

ADVANTAGES :

- › Mesh network
- › Direct connection with Amazon Echo and Google Home
- › Compatible with products from different manufacturers
- › High level of security
- › Easy setup
- › Energy efficient

VORTEILE:

- › Mesh-Netzwerk
- › Direkte Verbindung mit Amazon Echo und Google Home
- › Herstellerübergreifend kompatibel
- › Hohe Sicherheit
- › Einfache Einrichtung
- › Energieeffizient

AVANTAGES:

- › Réseau maillé
- › Connexion directe à Amazon Echo et Google Home
- › Compatible indépendamment du fabricant
- › Sécurité élevée
- › Installation facile
- › Économe en énergie

connect.2



Bluetooth is an established standard in the digital world.
Bluetooth ist ein etablierter Standard in der digitalen Welt.
Bluetooth est un standard de communication reconnu dans le monde numérique.

ADVANTAGES:

- › Local & secure network
- › Protocol is mainly audio (low debit)
- › Mesh network: Elements are receivers and senders
- › Easy setup
- › Usable offline
- › Energy efficient

VORTEILE:

- › Lokales & sicheres Netzwerk Protokoll hauptsächlich Audio (Low Debit)
- › Mesh-Netzwerk: Elemente sind Empfänger und Sender
- › Einfache Einrichtung
- › Offline nutzbar
- › Energieeffizient

AVANTAGES:

- › Réseau local et sûr
- › Protocole essentiellement audio (bas débit)
- › Réseau maillé : les éléments sont l'émetteur et le récepteur
- › Installation facile
- › Utilisable hors-ligne
- › Économe en énergie

Light up your world!

Bringen Sie Licht in Ihren Alltag!
Illuminez votre quotidien !



connect.z offers a wide range of lamps and lighting equipment. Select products from the following options according to your needs:
connect.z bietet ein großes Sortiment an Leuchten und Leuchtmitteln. Wählen Sie die Produkte ganz nach Ihren Bedürfnissen aus folgenden Varianten:
connect.z propose une large gamme de luminaires et d'ampoules. Sélectionnez les produits en fonction de vos besoins parmi les variantes suivantes :

Warm White

Neutral White

Tunable White

Individual light from 50,000 white tones.
Individuelles Licht aus 50.000 Weißtönen.
Luminaire individuel à 50 000 tons de blanc.

TW + RGB Colors

Diverse lighting selection from 50,000 white tones and 16 million colours.
Vielseitige Lichtauswahl aus 50.000 Weißtönen und 16 Mio. Farben.
Sélection étendue de luminaires à 50 000 tons de blanc et 16 millions de couleurs.

Enjoy relaxing moments!
Genießen Sie entspannte Momente!
Profitez de moments de détente !

Stay focussed & efficient!
Bleiben Sie konzentriert & leistungsfähig!
Restez concentré(e) et performant(e) !

Start the day fresh every morning!
Starten Sie jeden Morgen frisch in den Tag!
Commencez la journée du bon pied !

Create the perfect atmosphere!
Kreieren Sie Ihr perfektes Ambiente!
Créez votre ambiance parfaite !



Enjoy many useful convenience features:

Es erwarten Sie viele nützliche Komfortfunktionen:
De nombreuses fonctionnalités utiles vous attendent pour votre confort :



TIMERS AND CALENDARS / TIMER UND ZEITPLÄNE/ MINUTERIE ET CALENDRIER

Make your daily life easier with timers and calendars.
Wake up relaxed with the simulated sunrise.

Unterstützen Sie Ihren Alltag mit Timern und Zeitplänen. Entwickeln Sie eigene Lichtroutinen und machen Sie Ihr Leben leichter.

Facilitez-vous la vie à l'aide de la fonction minuterie et calendrier.
Réveillez-vous en douceur grâce au simulateur de lever de soleil

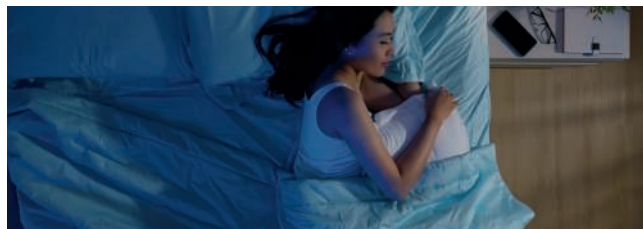

LIGHT ALARM CLOCK/ LICHTWECKER/ REVEIL LUMINEUX

You'd rather not start your day in a bad mood? Wake up relaxed with the simulated sunrise.

Keine Lust mit schlechter Laune in den Tag zu starten? Entspannt aufwachen mit dem simulierten Sonnenaufgang.

Pas envie de commencer la journée de mauvaise humeur ? Réveillez-vous en douceur grâce au simulateur de lever de soleil.



DISCO FUNCTION/MODE/ DISCOFUNKTION/MODUS/ FONCTION/MODE DISCO

For the perfect party mood, the disco function synchronises the light to the beat of your favourite songs.

Für die perfekte Partystimmung schaltet die Discofunktion das Licht passend zum Beat Ihres Lieblingsongs.

Pour une ambiance festive parfaite, la fonction disco enclenche le luminaire au rythme de votre chanson préférée.



PRESENCE SIMULATOR/ ANWESENHEITSSIMULATION/ SIMULATEUR DE PRESENCE

Protect your home with the convenient presence simulator. Variable time intervals allow the system to turn the lights on and off to simulate your presence at home and deter unwanted guests.

Schütze Sie Ihr Zuhause mit der komfortablen Anwesenheitssimulation. Dank variabler Zeitintervalle simuliert das System durch Ein- und Ausschalten der Beleuchtung die Anwesenheit im Haus und schreckt so ungebetene Gäste ab.

Protégez votre domicile à l'aide du très pratique simulateur de présence. Le système simule votre présence en allumant et en éteignant les lumières à intervalles variables et décourage ainsi les invités indésirables.

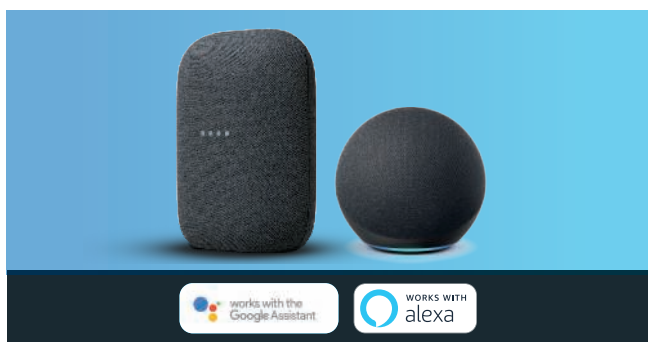

VOICE COMMANDS/ SPRACHSTEUERUNG/COMMANDE VOCALE

More convenient! Turn the light on whenever you want with only a voice command.

Noch komfortabler! Mit nur einem Sprachbefehl schaltet sich das Licht nach Ihren Wünschen an und aus.

C'est encore plus confortable ! Allumez votre luminaire comme vous le souhaitez d'une simple commande vocale.

Control options

Steuerungsmöglichkeiten
Possibilités de commande



Set your smart home as you prefer! With the app, voice commands, or remote control.

Steuern Sie Ihr Smart Home wie Sie es möchten! Via App, Sprachsteuerung oder mit der Fernbedienung.

Commandez votre Smart Home comme vous le souhaitez ! Via l'appli, la commande vocale ou la télécommande.

APP CONTROL



Use the free app for smartphone, tablet, or smartwatch.

Nutzen Sie die kostenlose App für das Smartphone, Tablet oder die Smartwatch.

Utilisez l'appli gratuite sur votre smartphone, votre tablette ou votre montre connectée.

VOICE COMMANDS



Use intelligent voice assistants such as Google Home and Amazon Alexa.

Nutzen Sie intelligente Sprachassistenten wie Google Home und Amazon Alexa.

Utilisez des assistants vocaux intelligents comme Google Home ou Amazon Alexa.

REMOTE CONTROL



Use the practical remote connect.z operation at any time.

Nutzen Sie auch jederzeit die praktische connect.z Fernbedienung.

Vous pouvez aussi utiliser à tout moment la télécommande connect.z.

CONNECT.Z ACCESSORIES



Use clever accessories such as the movement sensor and much more.

Nutzen Sie cleveres Zubehör wie z.B. den Bewegungssensor uvm.

Utilisez des accessoires malins tels que le capteur de mouvement et bien d'autres encore.

DIMMER FUNCTION



Use the practical dimmer function via app, speech command or remote control.

Nutzen Sie die praktische Dimmfunktion via App, Sprachbefehl oder Fernbedienung.

Utilisez la fonction de gradation via l'appli, la commande vocale ou la télécommande.

One system, many possibilities!

Ein System, viele Möglichkeiten!
Un système, de nombreuses possibilités!



No matter how you start, you can integrate new products into your connect.z system at any time and gradually expand your smart home. Egal wie Sie starten, Sie können jederzeit neue Produkte in Ihr connect.z System integrieren und Ihr smartes Zuhause nach und nach erweitern. Quel que soit votre choix, vous pouvez à tout moment intégrer de nouveaux produits à votre système connect.z et améliorer progressivement votre maison intelligente.



All you need to start is a connect.z product and the remote control. No internet connection is required and you have access to:

Sie benötigen zum Start lediglich ein connect.z Produkt und die Fernbedienung. Es wird kein Internetzugang benötigt und Sie haben Zugriff auf:

Pour démarrer, il vous suffit d'un produit connect.z et de la télécommande. Aucune connexion Internet n'est nécessaire. Vous avez accès aux :

Standard functions: Standardfunktionen: Fonctionnalités standard :

- › Select colour/ Farbauswahl/ sélection de couleur
- › Change colour/ Farbwechsel/ changement de couleur
- › Dim/ Dimmen/ gradation
- › Favourites (2x)/ Favoriten (2x)/ favoris (2x)
- › Groups (3x)/ Gruppen (3x)/ groupes (3x)
- › Candle mode/ Kerzenmodus/ mode bougie

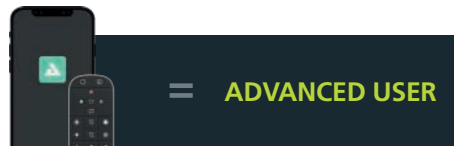

Besides the standard functions, would you also like access to the practical convenience features? Then you need only your smartphone or tablet and the Awox app. This app allows you to control your lights via Bluetooth®.

Sie möchten zu den Standardfunktionen auch noch Zugriff auf die praktischen Komfortfunktionen haben? Dann benötigen Sie nur Ihr Smartphone oder Tablet und die Awox App. Mit der App haben Sie die Möglichkeit, Ihre Leuchten über Bluetooth® zu steuern.

Outre les options standard, vous souhaitez également pouvoir utiliser les fonctionnalités de confort les plus pratiques ? Pour cela, vous avez seulement besoin de votre smartphone ou de votre tablette et de l'appli Awox. L'appli vous permet de commander vos luminaires via le réseau Bluetooth®.

Standard functions + convenience features/ Standardfunktionen + Komfortfunktionen / Fonctionnalités standard + confort

- › Light alarm clock/ Lichtwecker/ réveil lumineux
- › Presence simulation/ Anwesenheitssimulation/ simulateur de présence
- › Disco function/ Discofunktion/ fonction disco
- › Timers & timetables /Timer & Zeitpläne/ minuteur et calendrier
- › Accessories can be incorporated/ Einbindung von Zubehör möglich/ connexion d'accessoires possible



Use the system's full potential and control your smart home through the Awox app using WIFI or Bluetooth® as well as integrating a voice assistant into the system. This gives you:

Nutzen Sie das volle Potenzial des Systems und steuern Sie Ihr Smart Home über die Awox App mithilfe von WLAN oder Bluetooth® und integrieren Sie zusätzlich noch einen Sprachassistenten in das System. So mit erhalten Sie:

Exploitez tout le potentiel du système en commandant votre Smart Home grâce à l'appli Awox via le réseau Wi-Fi ou Bluetooth®, et intégrez également un assistant vocal au système. Vous obtenez ainsi :

Standard functions + convenience features + voice commands*

Standardfunktionen + Komfortfunktionen + Sprachsteuerung*

Fonctionnalités standard + confort + commande vocale*

- › Amazon Alexa or Google Home/ Amazon Alexa oder Google Home/ Amazon Alexa ou Google Home

- * Use a voice assistant with integrated bridge.
- * Nutzen Sie einen Sprachassistenten mit integrierter Bridge.
- * Utilisez un assistant vocal avec Bridge intégré.

You already have connect-c luminaires from the previous system! What now?

Sie besitzen bereits connect-c Leuchten des Vorgängersystems! Was nun?
Vous disposez déjà de luminaires connect-c de l'ancien système! Que faire ?

No problem! The previous connect-c products are compatible with the new connect.z system.
Kein Problem! Die bisherigen connect-c Produkte sind mit dem neuen connect.z System kompatibel.
Aucun problème! Les anciens produits connect-c sont compatibles avec le nouveau système connect.z.

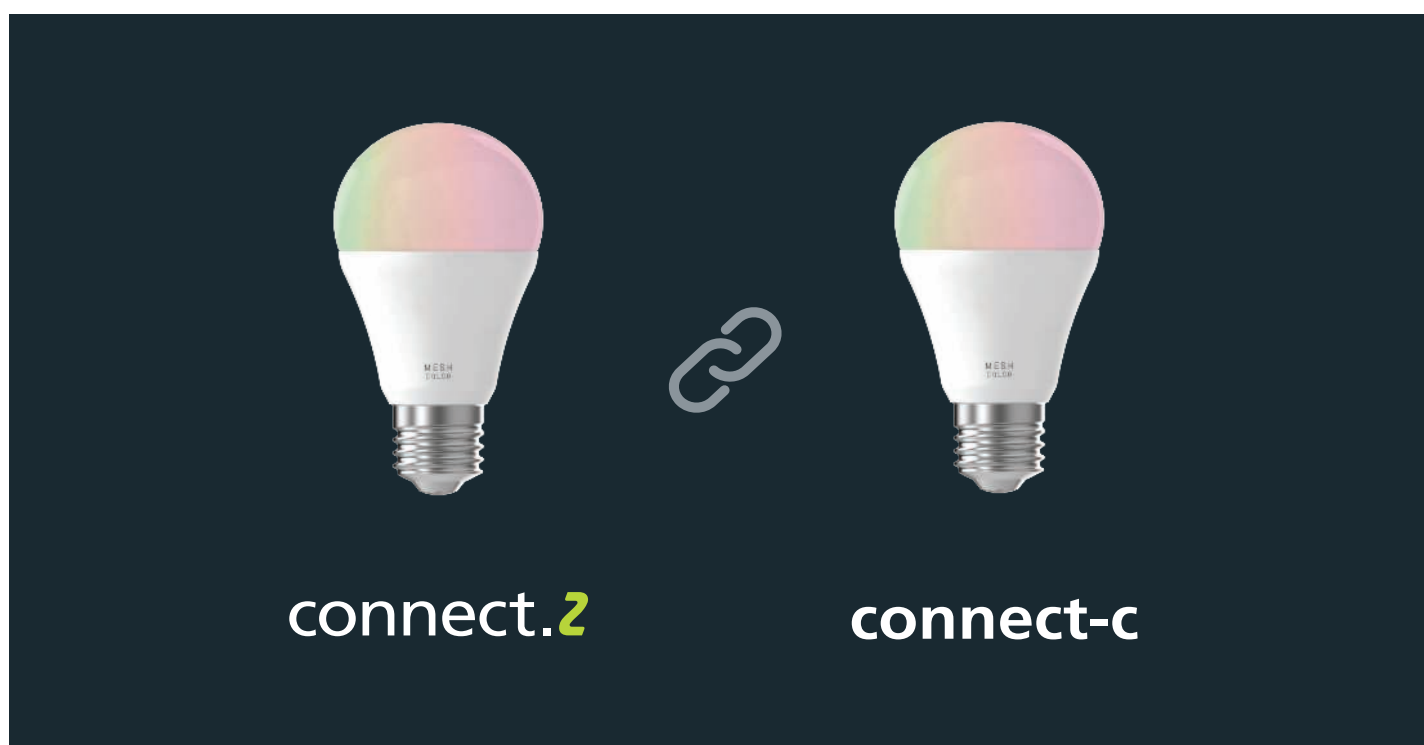

EGLO connect-c - connect.z

The existing EGLO connect-c system is compatible with the new EGLO connect.z system. You don't need to switch from the existing Bluetooth low energy system to the new open protocol ZigBee 3.0. Lights from EGLO connect-c can be incorporated into the existing EGLO connect.z system.

EGLO connect-c - connect.z

Das bestehende EGLO connect-c System ist mit dem neuen EGLO connect.z System kompatibel. Sie müssen nicht von dem bestehendem Bluetooth low energy System auf das neue offene Protokoll ZigBee 3.0 umsteigen. Leuchten von EGLO connect-c können in das bestehende EGLO connect.z System eingebunden werden.

EGLO connect-c - connect.z

Le système EGLO connect-c existant est compatible avec le nouveau système EGLO connect.z. Vous n'avez pas besoin de passer du système Bluetooth à basse consommation existant au nouveau protocole ouvert ZigBee 3.0. Les luminaires EGLO connect-c peuvent être intégrés au système EGLO connect.z existant.

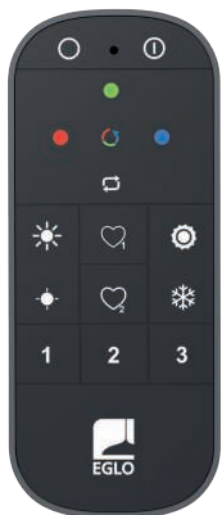

99099

99099 CONNECT Z

remote control; plastic, grey
Fernbedienung; Kunststoff, grau
Télécommande; plastique, gris

L 122, B 54, H 18



ACCU
AAA,
R03P



1,5V



9 002759 990992





99669





99669



99672



99671



99669 SALICETO-Z

recessed light; aluminium, black
 Einbauleuchte; Alu, schwarz
 luminaire encastrable; aluminium, noir

H 46, Ø 88, ET 50



Ø 88

99671 SALICETO-Z

recessed light; aluminium, white
 Einbauleuchte; Alu, weiss
 luminaire encastrable; aluminium, blanc

H 46, Ø 88, ET 50

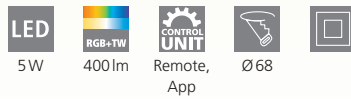

Ø 88

99672 SALICETO-Z

recessed light; aluminium, satin nickel
 Einbauleuchte; Alu, nickel-matt
 luminaire encastrable; aluminium, nickel mat

H 46, Ø 88, ET 50



Ø 88



900337



900336



900339



900337 TELIMBELA-Z

spot; steel, black
Spot; Stahl, schwarz
spot; acier, noir

L 580, B 80, H 97

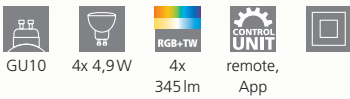

900336 TELIMBELA-Z

spot; steel, black
Spot; Stahl, schwarz
spot; acier, noir

H 97, Ø 250

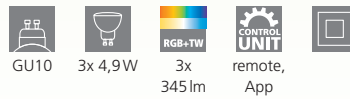

900339 TELIMBELA-Z

spot; steel, white
Spot; Stahl, weiss
spot; acier, blanc

L 580, B 80, H 97

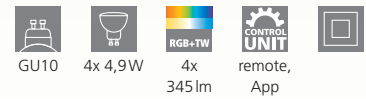



900338



900338 TELIMBELA-Z

spot; steel, white
Spot; Stahl, weiss
spot; acier, blanc

H 97, Ø 250



GU10



3x 4,9W



3x
345 lm



remote,
App



9 008606 239962

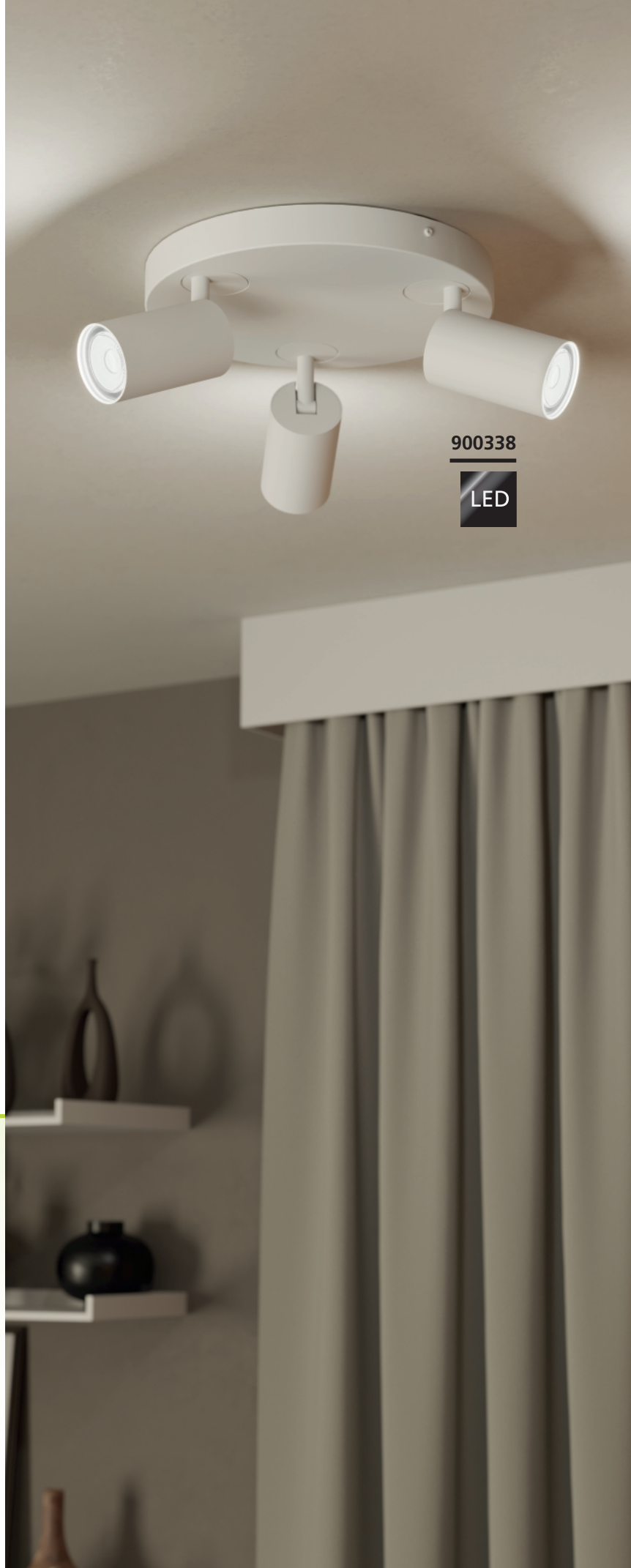

900338





900481



900482



900483



900481 PADROGIANO-Z

ceiling light; steel, white / plastic, white
Deckenleuchte; Stahl, weiss / Kunststoff, weiss
plafonnier; acier, blanc / plastique, blanc

L 450, B 450, H 50



26,2W 3800lm Remote, App

900482 PADROGIANO-Z

ceiling light; steel, white / plastic, white
Deckenleuchte; Stahl, weiss / Kunststoff, weiss
plafonnier; acier, blanc / plastique, blanc

L 1200, B 300, H 50



42,5W 6000lm Remote, App

900483 PADROGIANO-Z

ceiling light; steel, white / plastic, white
Deckenleuchte; Stahl, weiss / Kunststoff, weiss
plafonnier; acier, blanc / plastique, blanc

L 450, B 450, H 50



27,9W 3600lm Remote, App



9 008606 244164



9 008606 244171



9 008606 244188





900484

LED

DIMMABLE
VIA REMOTE
AND APP



PADROGIANO-Z

The frame of these luminaires can switch between the RGB colors, the inner part can reproduce different white tones between 2700K and 6500K. By controlling via app or remote control, individual lighting effects can be set.

Der Rahmen dieser Leuchten kann zwischen den RGB Farbtönen wechseln, der Innenteil kann verschiedene Weißtöne zwischen 2700K und 6500K wiedergeben. Durch Steuerung per App oder Fernbedienung können so individuelle Lichtspiele eingestellt werden.

Le cadre de cette luminaires peut basculer entre es couleurs RVB, la partie intérieure peut reproduire différents tons blancs entre 2700K et 6500K. En contrôlant via l'application ou la télécommande, des effets d'éclairage individuels peuvent être définis.

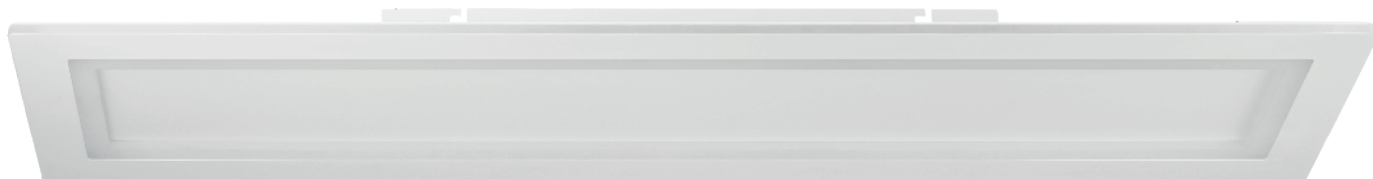

900485

LED

900484 PADROGIANO-Z

ceiling light; steel, white / plastic, white
Deckenleuchte; Stahl, weiss / Kunststoff, weiss
plafonnier; acier, blanc / plastique, blanc

L 595, B 595, H 50



35,5 W



4800 lm



Remote,
App



900485 PADROGIANO-Z

ceiling light; steel, white / plastic, white
Deckenleuchte; Stahl, weiss / Kunststoff, weiss
plafonnier; acier, blanc / plastique, blanc

L 1200, B 300, H 50



43,2 W



6000 lm



Remote,
App



9 008606 244195



L 595

B 595



9 008606 244201



L 1200

B 300



900486

LED

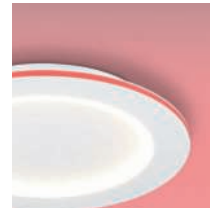

PADROGIANO-Z

These lights have individually controllable light settings on the inside and outside of the frame.

Diese Leuchten verfügen über individuell steuerbare Lichteinstellungen der Rahmen innen und außen.

Ces lumières ont des paramètres d'éclairage contrôlables individuellement du cadre.



900487

LED

900486 PADROGIANO-Z

ceiling light; steel, white / plastic, white
Deckenleuchte; Stahl, weiss / Kunststoff, weiss
plafonnier; acier, blanc / plastique, blanc

H 50, Ø 450



26,5W 3300lm Remote, App

900487 PADROGIANO-Z

ceiling light; steel, white / plastic, white
Deckenleuchte; Stahl, weiss / Kunststoff, weiss
plafonnier; acier, blanc / plastique, blanc

H 50, Ø 595



35W 4600lm Remote, App



9 008606 244218



9 008606 244225





900487

LED



900054

LED



900055

LED



900056

LED

900054 TURCONA-Z

ceiling light; steel, aluminium, white / plastic, white
Deckenleuchte; Stahl, Alu, weiss / Kunststoff, weiss
plafonnier; acier, aluminium, blanc / plastique, blanc

H 60, Ø 300

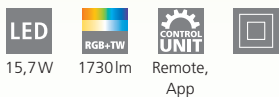

LED 15,7W RGB+TW 1730lm CONTROL UNIT Remote, App

900055 TURCONA-Z

ceiling light; steel, aluminium, white / plastic, white
Deckenleuchte; Stahl, Alu, weiss / Kunststoff, weiss
plafonnier; acier, aluminium, blanc / plastique, blanc

H 75, Ø 450



LED 22,4W RGB+TW 2490lm CONTROL UNIT Remote, App

900056 TURCONA-Z

ceiling light; steel, aluminium, white / plastic, white
Deckenleuchte; Stahl, Alu, weiss / Kunststoff, weiss
plafonnier; acier, aluminium, blanc / plastique, blanc

H 75, Ø 600



LED 34,2W RGB+TW 3980lm CONTROL UNIT Remote, App



9 008606 221905



9 008606 221912



9 008606 221929

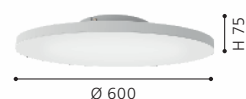



900055

LED



Travel makes
you realise that
no matter how
much you know,
there's always
more to learn.





99639

LED



99548

LED



99549

LED

99639 HERRORA-Z

ceiling light; aluminium, white / plastic, white
Deckenleuchte; Alu, weiss / Kunststoff, weiss
plafonnier; aluminium, blanc / plastique, blanc

L 450, B 450, H 40



99548 HERRORA-Z

ceiling light; aluminium, white / plastic, white
Deckenleuchte; Alu, weiss / Kunststoff, weiss
plafonnier; aluminium, blanc / plastique, blanc

L 595, B 595, H 40

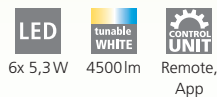

99549 HERRORA-Z

ceiling light; aluminium, white / plastic, white
Deckenleuchte; Alu, weiss / Kunststoff, weiss
plafonnier; aluminium, blanc / plastique, blanc

L 1200, B 300, H 40



9 002759 996390

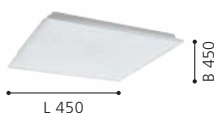

9 002759 995485

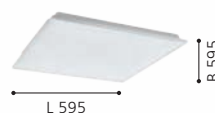

9 002759 995492





99639





900058



900057



900059



TURCONA-Z

Frameless luminaire

Rahmenlose Leuchte

Luminaire sans cadre

900057 TURCONA-Z

ceiling light; steel, aluminium, white / plastic, white
Deckenleuchte; Stahl, Alu, weiss / Kunststoff, weiss
plafonnier; acier, aluminium, blanc / plastique, blanc

L 300, B 300, H 50

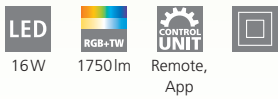

900058 TURCONA-Z

ceiling light; steel, aluminium, white / plastic, white
Deckenleuchte; Stahl, Alu, weiss / Kunststoff, weiss
plafonnier; acier, aluminium, blanc / plastique, blanc

L 450, B 450, H 70



900059 TURCONA-Z

ceiling light; steel, aluminium, white / plastic, white
Deckenleuchte; Stahl, Alu, weiss / Kunststoff, weiss
plafonnier; acier, aluminium, blanc / plastique, blanc

L 600, B 600, H 75



9 008606 221936

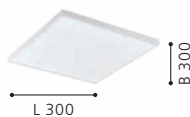

9 008606 221943

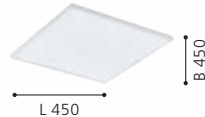

9 008606 221950

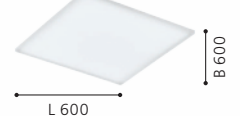



900062



900061



900061



900062 TURCONA-Z

ceiling light; steel, aluminium, white / plastic, white
Deckenleuchte; Stahl, Alu, weiss / Kunststoff, weiss
plafonnier; acier, aluminium, blanc / plastique, blanc

L 1200, B 100, H 50

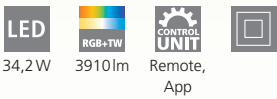

900061 TURCONA-Z

ceiling light; steel, aluminium, white / plastic, white
Deckenleuchte; Stahl, Alu, weiss / Kunststoff, weiss
plafonnier; acier, aluminium, blanc / plastique, blanc

L 1200, B 300, H 50

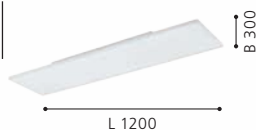



900044 SALOBRENA-Z

ceiling light; aluminium, white / plastic, white
Deckenleuchte; Alu, weiss / Kunststoff, weiss
plafonnier; aluminium, blanc / plastique, blanc

L 300, B 300, H 50



900045 SALOBRENA-Z

ceiling light; aluminium, white / plastic, white
Deckenleuchte; Alu, weiss / Kunststoff, weiss
plafonnier; aluminium, blanc / plastique, blanc

L 450, B 450, H 50



900046 SALOBRENA-Z

ceiling light; aluminium, white / plastic, white
Deckenleuchte; Alu, weiss / Kunststoff, weiss
plafonnier; aluminium, blanc / plastique, blanc

L 595, B 595, H 50

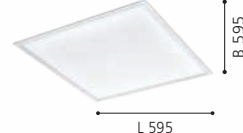
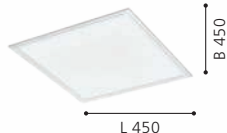
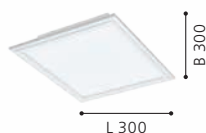



900047



900048



900047 SALOBRENA-Z

ceiling light; aluminium, white / plastic, white
Deckenleuchte; Alu, weiss / Kunststoff, weiss
plafonnier; aluminium, blanc / plastique, blanc

L 1200, B 300, H 50

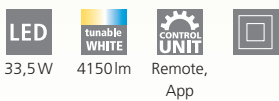

900048 SALOBRENA-Z

ceiling light; aluminium, white / plastic, white
Deckenleuchte; Alu, weiss / Kunststoff, weiss
plafonnier; aluminium, blanc / plastique, blanc

L 1200, B 100, H 45

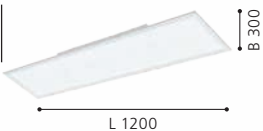

Zubehör inkludiert
Accessoires inclus



900049 SALOBRENA-Z

ceiling light; aluminium, black / plastic, white
Deckenleuchte; Alu, schwarz / Kunststoff, weiss
plafonnier; aluminium, noir / plastique, blanc

L 300, B 300, H 50

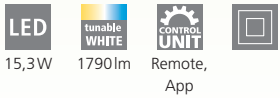

900051 SALOBRENA-Z

ceiling light; aluminium, black / plastic, white
Deckenleuchte; Alu, schwarz / Kunststoff, weiss
plafonnier; aluminium, noir / plastique, blanc

L 450, B 450, H 50



900052 SALOBRENA-Z

ceiling light; aluminium, black / plastic, white
Deckenleuchte; Alu, schwarz / Kunststoff, weiss
plafonnier; aluminium, noir / plastique, blanc

L 595, B 595, H 50

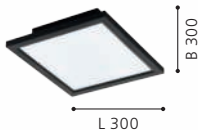



900053

LED



900095

LED



900053 SALOBRENA-Z

ceiling light; aluminium, black / plastic, white
Deckenleuchte; Alu, schwarz / Kunststoff, weiss
plafonnier; aluminium, noir / plastique, blanc

L 1200, B 300, H 50



900095 SALOBRENA-Z

ceiling light; aluminium, steel, black / plastic, white
Deckenleuchte; Alu, Stahl, schwarz / Kunststoff, weiss
plafonnier; aluminium, acier, noir / plastique, blanc

L 1200, B 100, H 45

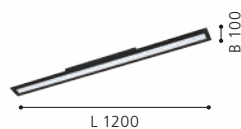

Zubehör inkludiert
Accessoires inclus



900099



IP20/44

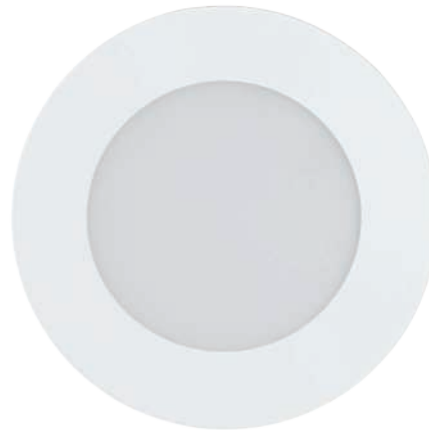

900101



IP20/44

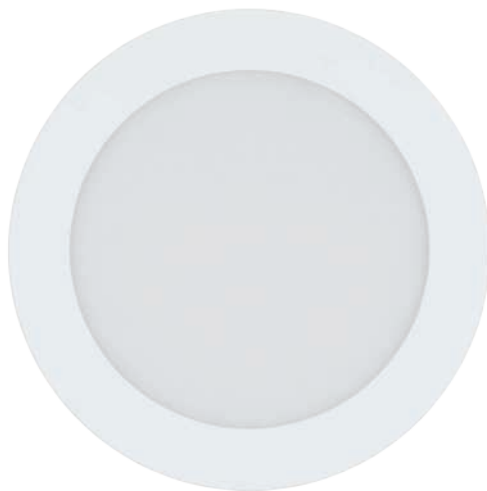

900102



IP20/44

900099 FUEVA-Z

recessed light; steel, white / plastic, white
Einbauleuchte; Stahl, weiss / Kunststoff, weiss
luminaire encastrable; acier, blanc / plastique, blanc

H 26, Ø 85



9 008606 225569



Ø 85

H 26, Ø 120

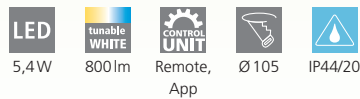

9 008606 225576



Ø 120

900102 FUEVA-Z

recessed light; steel, white / plastic, white
Einbauleuchte; Stahl, weiss / Kunststoff, weiss
luminaire encastrable; acier, blanc / plastique, blanc

H 26, Ø 165

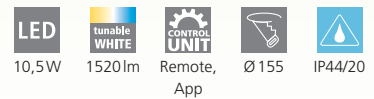

9 008606 225583



Ø 165

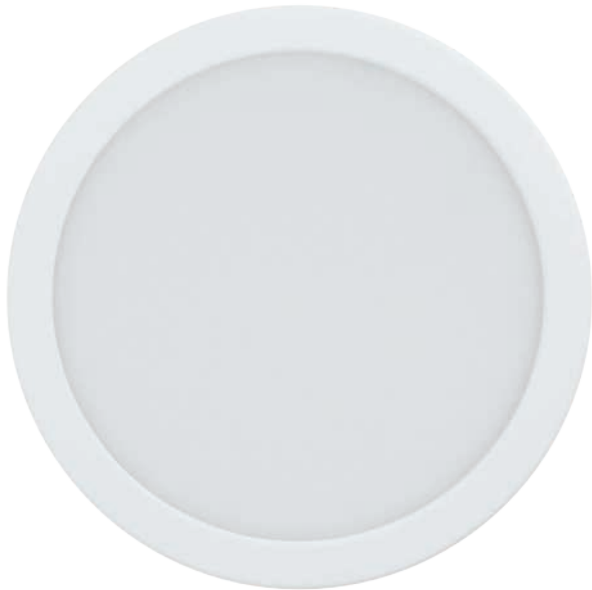

98842



IP20/44



98842



IP20/44

98842 FUEVA-Z

recessed light; aluminium, white / plastic, white
 Einbauleuchte; Alu, weiss / Kunststoff, weiss
 luminaire encastrable; aluminium, blanc / plastique, blanc

Ø 216, ET 26

- LED
16,5 W
- tunable
WHITE
2100 lm
- CONTROL
UNIT
Remote,
App
- Ø205
- IP44/20



Ø 216



900111



IP20/44



900112



IP20/44



900113



IP20/44

900111 FUEVA-Z

recessed light; steel, satin nickel / plastic, white
Einbauleuchte; Stahl, nickel-matt / Kunststoff, weiss
luminaire encastrable; acier, nickel mat / plastique, blanc

900112 FUEVA-Z

recessed light; steel, satin nickel / plastic, white
Einbauleuchte; Stahl, nickel-matt / Kunststoff, weiss
luminaire encastrable; acier, nickel mat / plastique, blanc

900113 FUEVA-Z

recessed light; steel, satin nickel / plastic, white
Einbauleuchte; Stahl, nickel-matt / Kunststoff, weiss
luminaire encastrable; acier, nickel mat / plastique, blanc

H 26, Ø 85



3x 2,8W



3x 390lm



Remote, App



Ø 75



IP44/20



9 008606 225668



H 26, Ø 120



5,4W



800lm



Remote, App



Ø 105



IP44/20



9 008606 225675



H 26, Ø 165



10,5W



1520lm



Remote, App



Ø 155



IP44/20



9 008606 225682





98844



IP20/44

98844 FUEVA-Z

recessed light; aluminium, satin nickel / plastic, white
 Einbauleuchte; Alu, nickel-matt / Kunststoff, weiss
 luminaire encastrable; aluminium, nickel mat / plastique, blanc

Ø 216, ET 26



16,5 W



2100 lm



Remote, App



Ø 205



IP44/20



Ø 216



98844



IP20/44



900105



IP20/44



900106



IP20/44



900107



IP20/44

900105 FUEVA-Z

recessed light; steel, black / plastic, white
Einbauleuchte; Stahl, schwarz / Kunststoff, weiss
luminaire encastrable; acier, noir / plastique, blanc

H 26, Ø 85



9 008606 225613



Ø 85

H 26, Ø 120



9 008606 225620



Ø 120

900107 FUEVA-Z

recessed light; steel, black / plastic, white
Einbauleuchte; Stahl, schwarz / Kunststoff, weiss
luminaire encastrable; acier, noir / plastique, blanc

H 26, Ø 165



9 008606 225637



Ø 165



98846



IP20/44

98846 FUEVA-Z

recessed light; aluminium, black / plastic, white
 Einbauleuchte; Alu, schwarz / Kunststoff, weiss
 luminaire encastrable; aluminium, noir / plastique, blanc

Ø 216, ET 26



16,5 W



2100 lm



Remote, App



Ø205



IP44/20

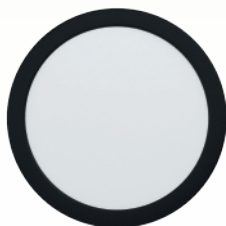

Ø 216



900107



IP20/44



900103



IP44



900104



IP44



98843



IP44

900103 FUEVA-Z

surface-mounted light; steel, white / plastic, white
Aufbauleuchte; Stahl, weiss / Kunststoff, weiss
luminaire en saillie; acier, blanc / plastique, blanc

H 28, Ø 210

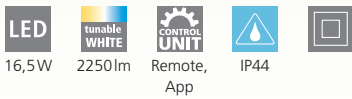

98843 FUEVA-Z

surface-mounted light; aluminium, white / plastic, white
Aufbauleuchte; Alu, weiss / Kunststoff, weiss
luminaire en saillie; aluminium, blanc / plastique, blanc

H 28, Ø 285

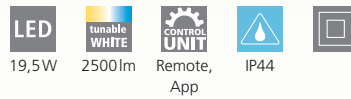

900104 FUEVA-Z

surface-mounted light; steel, white / plastic, white
Aufbauleuchte; Stahl, weiss / Kunststoff, weiss
luminaire en saillie; acier, blanc / plastique, blanc

L 210, B 210, H 28

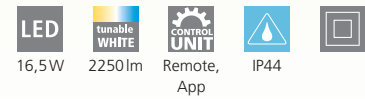

9 008606 225590



9 002759 988432

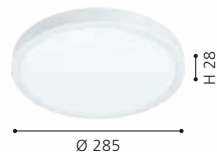

9 008606 225606

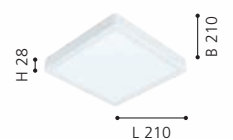



98849



IP44

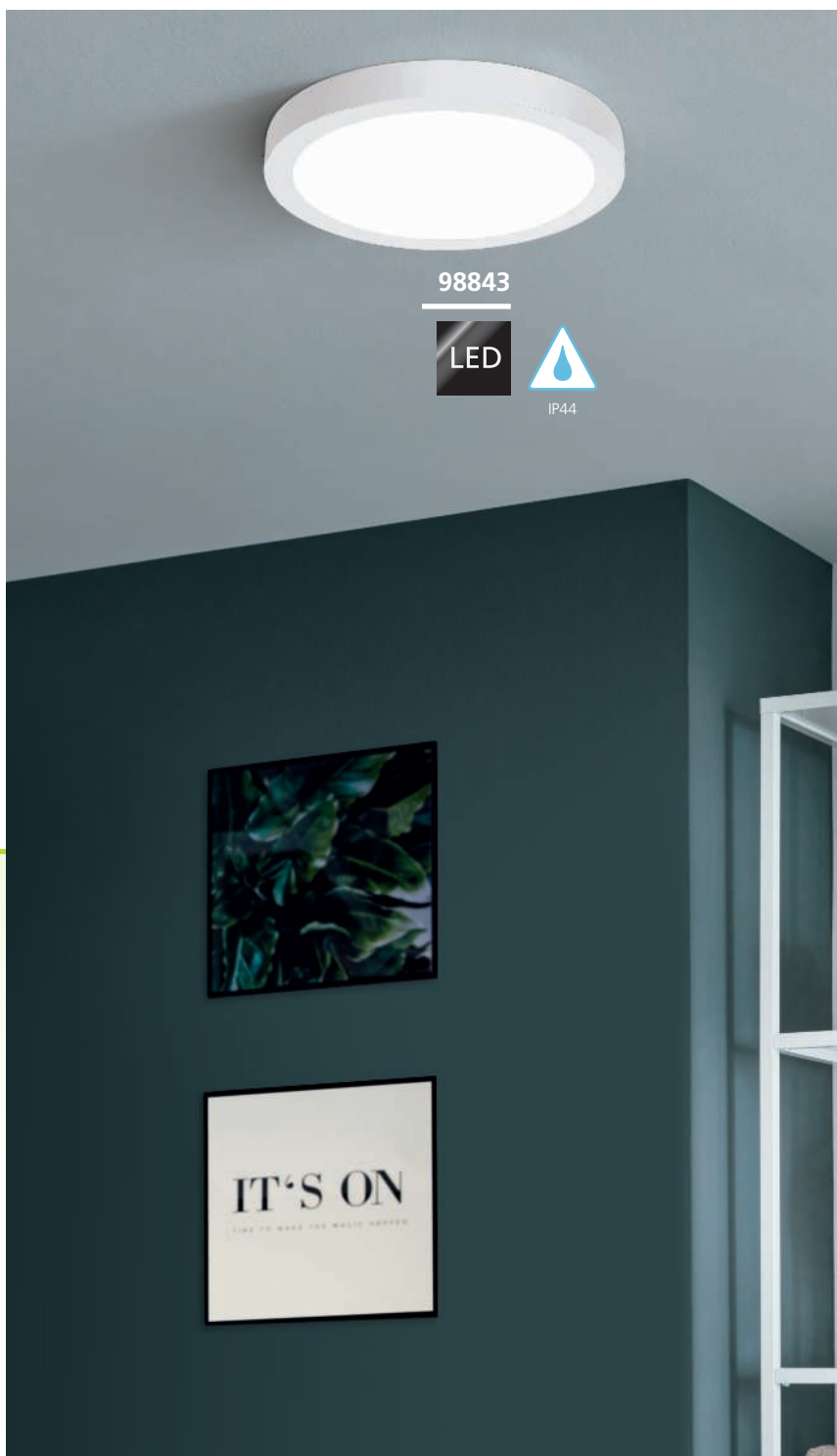

98843



IP44

98849 FUEVA-Z

surface-mounted light; aluminium, white / plastic, white
 Aufbauleuchte; Alu, weiss / Kunststoff, weiss
 luminaire en saillie; aluminium, blanc / plastique, blanc

L 285, B 285, H 28



19,5 W



2500 lm



Remote,
App



IP44

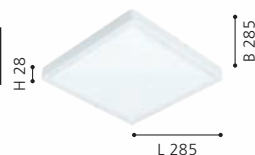



900114



IP44



900115



IP44



98845



IP44

900114 FUEVA-Z

surface-mounted light; steel, satin nickel / plastic, white
Aufbauleuchte; Stahl, nickel-matt / Kunststoff, weiss
luminaire en saillie; acier, nickel mat / plastique, blanc

H 28, Ø 210



16,5W



2250lm



Remote,
App



IP44



9 008606 225699



Ø 210

98845 FUEVA-Z

surface-mounted light; aluminium, satin nickel / plastic, white
Aufbauleuchte; Alu, nickel-matt / Kunststoff, weiss
luminaire en saillie; aluminium, nickel mat / plastique, blanc

H 28, Ø 285



19,5W



2500lm



Remote,
App



IP44



9 002759 988456



Ø 285

900115 FUEVA-Z

surface-mounted light; steel, satin nickel / plastic, white
Aufbauleuchte; Stahl, nickel-matt / Kunststoff, weiss
luminaire en saillie; acier, nickel mat / plastique, blanc

L 210, B 210, H 28



16,5W



2250lm



Remote,
App



IP44



9 008606 225705



H 28

L 210



98852



IP44



98852



IP44

98852 FUEVA-Z

surface-mounted light; aluminium, satin nickel / plastic, white
Aufbauleuchte; Alu, nickel-matt / Kunststoff, weiss
luminaire en saillie; aluminium, nickel mat / plastique, blanc

L 285, B 285, H 28



19,5 W



2500 lm



Remote,
App



IP44



9 002759 988524

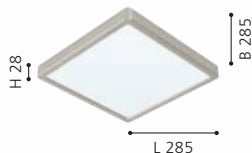



900108



IP44



900109



IP44



98847



IP44

900108 FUEVA-Z

surface-mounted light; steel, black / plastic, white
Aufbauleuchte; Stahl, schwarz / Kunststoff, weiss
luminaire en saillie; acier, noir / plastique, blanc

H 28, Ø 210

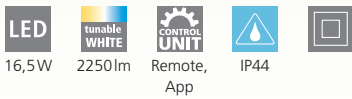

98847 FUEVA-Z

surface-mounted light; aluminium, black / plastic, white
Aufbauleuchte; Alu, schwarz / Kunststoff, weiss
luminaire en saillie; aluminium, noir / plastique, blanc

H 28, Ø 285

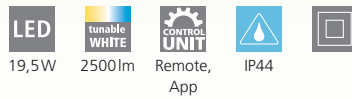

900109 FUEVA-Z

surface-mounted light; steel, black / plastic, white
Aufbauleuchte; Stahl, schwarz / Kunststoff, weiss
luminaire en saillie; acier, noir / plastique, blanc

L 210, B 210, H 28

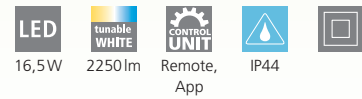

9 008606 225644



9 002759 988470

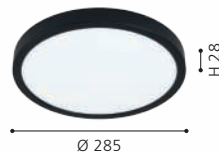

9 008606 225651





98854



IP44



900109



IP44

98854 FUEVA-Z

surface-mounted light; aluminium, black / plastic, white
Aufbauleuchte; Alu, schwarz / Kunststoff, weiss
luminaire en saillie; aluminium, noir / plastique, blanc

L 285, B 285, H 28



19,5W



2500lm



Remote,
App



IP44



9 002759 988548





900088

LED



900086

LED



900089

LED

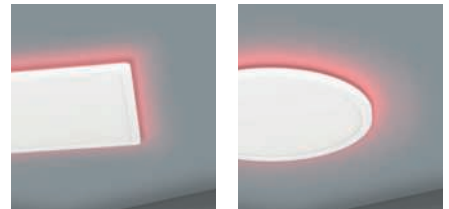

ROVITO-Z

These lights have individually controllable light settings on the inside and outside of the frame.

Diese Leuchten verfügen über individuell steuerbare Lichteinstellungen der Rahmen innen und außen.

Ces lumières ont des paramètres d'éclairage contrôlables individuellement du cadre.

900088 ROVITO-Z

ceiling light; plastic, white / plastic, white
Deckenleuchte; Kunststoff, weiss / Kunststoff, weiss
plafonnier; plastique, blanc / plastique, blanc

L 295, B 295, H 25



LED 14,6W RGB+TW 1700lm Remote, App



9 008606 225491



900089 ROVITO-Z

ceiling light; plastic, white / plastic, white
Deckenleuchte; Kunststoff, weiss / Kunststoff, weiss
plafonnier; plastique, blanc / plastique, blanc

L 420, B 420, H 25



LED 16,5W RGB+TW 2200lm Remote, App



9 008606 225507

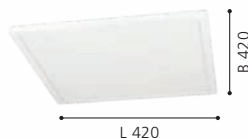

900086 ROVITO-Z

ceiling light; plastic, white / plastic, white
Deckenleuchte; Kunststoff, weiss / Kunststoff, weiss
plafonnier; plastique, blanc / plastique, blanc

H 25, Ø 295



LED 14,6W RGB+TW 1700lm Remote, App



9 008606 225477





900087



900087



900087 ROVITO-Z

ceiling light; plastic, white / plastic, white
Deckenleuchte; Kunststoff, weiss / Kunststoff, weiss
plafonnier; plastique, blanc / plastique, blanc

H 25, Ø 420



16,5 W



2200lm



Remote,
App



9 008606 225484





900093

LED



900091

LED



900094

LED

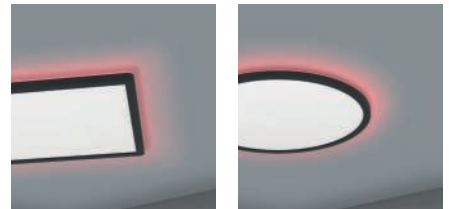

ROVITO-Z

These lights have individually controllable light settings on the inside and outside of the frame.

Diese Leuchten verfügen über individuell steuerbare Lichteinstellungen der Rahmen innen und außen.

Ces lumières ont des paramètres d'éclairage contrôlables individuellement du cadre.

900093 ROVITO-Z

ceiling light; plastic, black / plastic, white
Deckenleuchte; Kunststoff, schwarz / Kunststoff, weiss
plafonnier; plastique, noir / plastique, blanc

L 295, B 295, H 25

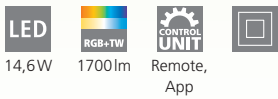

14,6W 1700lm Remote, App



9 008606 225538



900094 ROVITO-Z

ceiling light; plastic, black / plastic, white
Deckenleuchte; Kunststoff, schwarz / Kunststoff, weiss
plafonnier; plastique, noir / plastique, blanc

L 420, B 420, H 25



16,5W 2200lm Remote, App



9 008606 225545



900091 ROVITO-Z

ceiling light; plastic, black / plastic, white
Deckenleuchte; Kunststoff, schwarz / Kunststoff, weiss
plafonnier; plastique, noir / plastique, blanc

H 25, Ø 295



14,6W 1700lm Remote, App



9 008606 225514





900092

LED



DIMMABLE
VIA REMOTE
AND APP



900091

LED

900092 ROVITO-Z

ceiling light; plastic, black / plastic, white
Deckenleuchte; Kunststoff, schwarz / Kunststoff, weiss
plafonnier; plastique, noir / plastique, blanc

H 25, Ø 420

LED

16,5 W

RGB+TW

2200 lm

CONTROL
UNIT

Remote,
App





99686

99687



99684

99685



99684

Driver included

Treiber inkludiert

Chauffeur inclus

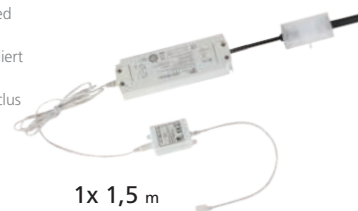

1x 1,5 m



99685

Extension for starter set 99684 without driver

Erweiterung für Starterset 99684 ohne Treiber

Rallonge pour kit de démarrage 99684 sans pilote

99686, 99687

Driver included

Treiber inkludiert

Chauffeur inclus



1x 1,5 m

99686 LED STRIPE-Z

bar / strip light; plastic, white
Leuchtband/-stab; Kunststoff, weiss
bande lumineuse / bâton l; plastique, blanc

L 5000, B 10



11W 1250lm Remote, App

99687 LED STRIPE-Z

bar / strip light; plastic, white
Leuchtband/-stab; Kunststoff, weiss
bande lumineuse / bâton l; plastique, blanc

L 8000, B 12, H 3



8x 3W 2640lm Remote, App

99684 LED STRIPE-Z

bar / strip light; plastic, white
Leuchtband/-stab; Kunststoff, weiss
bande lumineuse / bâton l; plastique, blanc

L 3000, B 8



13,5W 1450lm Remote, App



9 002759 996864



L 5000



9 002759 996871



L 8000



9 002759 996840



L 3000



99687

LED

99685 LED STRIPE-Z

bar / strip light; plastic, white
 Leuchtband/-stab; Kunststoff, weiss
 bande lumineuse / bâton l; plastique, blanc

L 2000, B 8



9W



950lm



Remote,
App

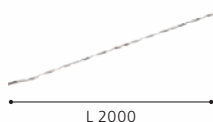

EGLO Access

Let **light** follow
your **life**



OVERVIEW



ACCESS REMOTE
p. 58



SARSINA-A
p. 58-59



SALOBRENA-A
p. 60-61



FUEVA-A
p. 63



This product is available in different colors and shapes./ Dieser Artikel ist in unterschiedlichen Farben und Formen verfügbar.
Cet article est disponible en différentes couleurs et formes.



LET LIGHT FOLLOW YOUR LIFE

DAS LICHT, DAS SICH IHREM LEBEN ANPASST
LA LUMIÈRE QUE S'ADAPTE À VOTRE VIE



Light influences our lives and our work. For example, bright neutral white light improves focus, while warm, dimmed light makes us feel comfortable. You can adjust your EGLO Access luminaires to your requirements or mood.

- › One remote control for different light scenarios
- › 4-predefined settings
- › Tunable white: individually adjustable from warm white to cold white
- › Dimmable with incl. remote control
- › 2 memory functions for individual light

THE SYSTEM'S ADVANTAGES ARE:



Quick and simple installation



One remote control for up to 8 different items and a control distance up to 10 meters.



Light colour from 2700K to 6500K



No internet access necessary

Licht beeinflusst unser Leben und unsere Tätigkeiten. Zum Beispiel fördert helles, neutralweißes Licht die Konzentration, wohingegen warmes, gedimmtes Licht uns ein Gefühl von Behaglichkeit gibt. Je nach Anforderung oder Stimmung können Sie Ihre EGLO Access Leuchte individuell einstellen.

- › Eine Fernbedienung für verschiedene Lichtszenarien
- › 4 vordefinierte Einstellungen
- › Tunable white: individuell einstellbar von Warmweiß bis Kaltweiß
- › Dimmbar mit inkludierter Fernbedienung
- › 2 Speicherfunktionen für individuelles Licht

DIE VORTEILE DES SYSTEMS SIND:

Schnelle und einfache Installation

Eine Fernbedienung für bis zu 8 verschiedene Artikel und steuerbar bis zu 10 Meter

Lichtfarbe von 2700K bis 6500K

Kein Internetzugang erforderlich

La lumière influence nos vies et nos activités. Par exemple, une lumière blanche brillante et neutre favorise la concentration, tandis qu'une lumière chaude et atténuée nous procure une sensation de confort. En fonction de vos besoins ou de votre humeur, vous pouvez régler votre éclairage EGLO Access.

- › Une seule télécommande pour différents scénarios d'éclairage
- › 4 paramètres prédéfinis à l'emploi
- › Tunable white : réglable individuellement du blanc chaud au blanc froid
- › Graduable avec télécommande incluse
- › 2 fonctions mémoire pour un éclairage individuel

LES AVANTAGES DU SYSTÈME SONT :

Installation simple et rapide

Une seule télécommande pour jusqu'à 8 articles différents et contrôlable jusqu'à 10 mètres

Couleur de lumière de 2 700 K à 6 500 K

Aucun accès internet nécessaire

FUNCTIONS

FUNKTIONEN FONCTIONS

Relax with warm light and leave the hustle and bustle of everyday life behind you. Concentrate on your work or dispel fatigue, with neutral white light the energy level is replenished. EGLO Access offers these possibilities and many more. All functions and highlights at a glance:

- › It works with radio frequency technology and allows 360 degree control
- › Controllable up to a distance of 10 meters
- › Up to 8 different items can be connected
- › Easy handling thanks to 4 ready-made settings and 2 memory functions

NIGHT LIGHT
RELAX MODE
WORK MODE
SWITCH OFF AFTER 30 MINUTES

Mit warmem Licht entspannen und die Hektik des Alltages hinter sich lassen. Konzentriert arbeiten oder die Müdigkeit vertreiben, mit neutralweißem Licht wird das Energielevel wieder aufgefüllt. Diese Möglichkeiten und noch viele mehr bietet Ihnen EGLO Access. Alle Funktionen und Highlights auf einem Blick:

- › Es arbeitet mit Funktechnologie und ermöglicht eine 360-Grad-Steuerung
- › Steuerbar bis zu einer Entfernung von 10 Metern
- › Bis zu 8 verschiedene Artikel können miteinander verbunden werden
- › Einfache Handhabung durch 4 vorgefertigte Einstellungen und 2 Speicherfunktionen

NACHTLICHT
ENTSPANNUNGSMODUS
ARBEITSMODUS
AUSSCHALTEN NACH 30 MINUTEN

Lumière chaude pour se détendre et laisser l'agitation quotidienne derrière soi. Travailler de manière concentrée ou chasser la fatigue, avec une lumière blanche neutre, le niveau d'énergie est rétabli. EGLO Access vous offre ces possibilités et bien d'autres encore. Toutes les fonctions et les points forts en un coup d'œil :

- › Il fonctionne avec la technologie de la fréquence radio et permet un contrôle à 360 degrés
- › Contrôlable jusqu'à une distance de 10 mètres
- › Jusqu'à 8 articles différents peuvent être connectés ensemble
- › Manipulation facile grâce à 4 réglages prêts à l'emploi et 2 fonctions mémoire

VEILLEUSE
MODE DE DÉCOMPRESSION
MODE DE TRAVAIL
EXTINCTION APRÈS 30 MINUTES

COLOUR TEMPERATURES SCALE / FARBTEMPERATUREN SKALA / ÉCHELLE DES TEMPÉRATURES DE COULEUR



REMOTE CONTROL

FERNBEDIENUNG
TÉLÉCOMMANDE

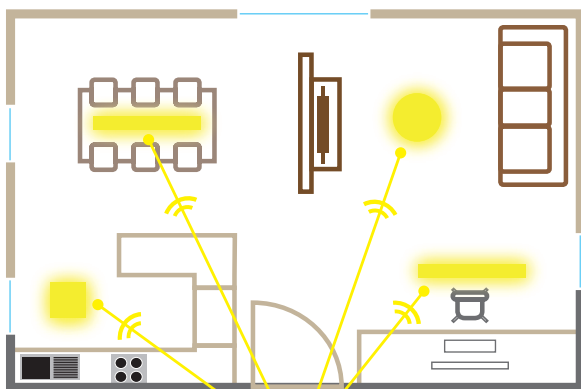

no internet necessary
kein Internet erforderlich
nul besoin d'internet



Control up to 8 EGLO Access luminaires
Bis zu 8 EGLO Access Leuchten steuerbar
Contrôle jusqu'à 8 luminaires EGLO Access



98207



98208



33199

33199 ACCESS REMOTE

remote control; plastic, anthracite
Fernbedienung; Kunststoff, anthrazit
Télécommande; plastique, gris anthracite

L 118, B 45



CR2032

98207 SARSINA-A

ceiling light; aluminium, white / plastic, white
Deckenleuchte; Alu, weiss / Kunststoff, weiss
plafonnier; aluminium, blanc / plastique, blanc

H 50, Ø 300



14W



2000lm



remote



98208 SARSINA-A

ceiling light; aluminium, white / plastic, white
Deckenleuchte; Alu, weiss / Kunststoff, weiss
plafonnier; aluminium, blanc / plastique, blanc

H 50, Ø 450



19,5W



2750lm



remote



9 002759 331993



B 45



9 002759 982072



Ø 300



9 002759 982089



Ø 450



98209



98209



98209 SARSINA-A

ceiling light; aluminium, white / plastic, white
Deckenleuchte; Alu, weiss / Kunststoff, weiss
plafonnier; aluminium, blanc / plastique, blanc

H 50, Ø 600



30W



4000lm



remote



9 002759 982096



Ø 600



98201 SALOBRENA-A
 ceiling light; aluminium, white / plastic, white
 Deckenleuchte; Alu, weiss / Kunststoff, weiss
 plafonnier; aluminium, blanc / plastique, blanc

98297 SALOBRENA-A
 ceiling light; aluminium, white / plastic, white
 Deckenleuchte; Alu, weiss / Kunststoff, weiss
 plafonnier; aluminium, blanc / plastique, blanc

98203 SALOBRENA-A
 ceiling light; aluminium, white / plastic, white
 Deckenleuchte; Alu, weiss / Kunststoff, weiss
 plafonnier; aluminium, blanc / plastique, blanc

L 300, B 300, H 50



L 450, B 450, H 50



L 600, B 600, H 50





98205

LED



98206

LED



98205 SALOBRENA-A

ceiling light; aluminium, white / plastic, white
Deckenleuchte; Alu, weiss / Kunststoff, weiss
plafonnier; aluminium, blanc / plastique, blanc

L 1200, B 300, H 50



98206 SALOBRENA-A

ceiling light; aluminium, white / plastic, white
Deckenleuchte; Alu, weiss / Kunststoff, weiss
plafonnier; aluminium, blanc / plastique, blanc

L 1195, B 100, H 50

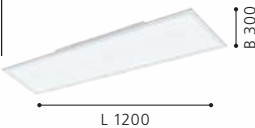



98212

LED



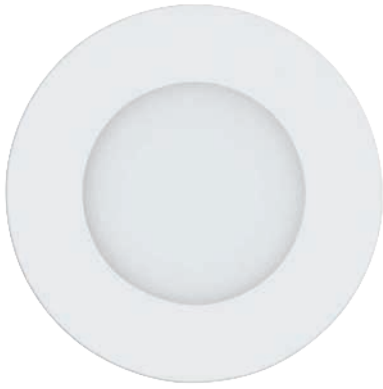

98212

LED

incl./inkl./inclus



98292

LED

incl./inkl./inclus



98293

LED

incl./inkl./inclus



98212 FUEVA-A

recessed light; aluminium, white / plastic, white
Einbauleuchte; Alu, weiss / Kunststoff, weiss
luminaire encastrable; aluminium, blanc / plastique, blanc

Ø 120, ET 30



5W



700lm



remote



Ø 108



9 002759 982126



Ø 120

98292 FUEVA-A

surface-mounted light; aluminium, white / plastic, white
Aufbauleuchte; Alu, weiss / Kunststoff, weiss
luminaire en saillie; aluminium, blanc / plastique, blanc

H 30, Ø 225



14W



2000lm



remote



9 002759 982928



Ø 225

H 30

98293 FUEVA-A

surface-mounted light; aluminium, white / plastic, white
Aufbauleuchte; Alu, weiss / Kunststoff, weiss
luminaire en saillie; aluminium, blanc / plastique, blanc

H 30, Ø 300



20W



2650lm



remote



9 002759 982935



Ø 300

H 30

EGLO TRACK SYSTEM

ADVANTAGES

- > LED PHASE SYSTEMS ARE INCREASING IN POPULARITY, WHETHER IN LIVING SPACES OR AS ACCENT LIGHTING: NOWADAYS THEY ARE FOUND THROUGHOUT THE INTERIOR FINISH.
 - > LED LIGHTING PANELS AND LIGHT FIXTURES OFFER UNMATCHED FLEXIBILITY. EGLO HAS DEVELOPED TWO LED LIGHTING PANEL SYSTEMS:
EGLO TRACK PRO IS OUR COMPLEX LINEAR SYSTEM FOR THE TRADE SECTOR, NOW ADAPTED FOR DIY CUSTOMERS. HIGH-QUALITY, ROBUST MATERIALS GUARANTEE A LONG SERVICE LIFE.
EGLO TRACK BASIC IS THE MOST USER-FRIENDLY SINGLE-PHASE SYSTEM ON THE MARKET. ALL OUR EGLO TRACK SYSTEMS CAN BE USED TO SET THE SCENE IN A ROOM, SPACE OR AROUND AN OBJECT.
 - > THE NEW SYSTEM OFFERS DIVERSE, FLEXIBLE POSSIBILITIES FOR ILLUMINATING ARCHITECTURE, INTERIORS OR EVEN INDIVIDUAL OBJECTS TO THEIR BEST EFFECT AND CREATING ATMOSPHERE IN A ROOM.
-

VORTEILE

- > LED-PHASENSYSTEME FINDEN IMMER MEHR ANWENDUNG - IM WOHNRAUM, ODER AUCH ALS AKZENTBELEUCHTUNG - MITTLERWEILE ALSO IM GESAMTEN BEREICH DES INNENAUSBAUS.
 - > LED-LICHTLEISTEN UND LEUCHTEN SIND SO FLEXIBEL EINSETZBAR, WIE KEIN ANDERES LEUCHTMITTEL. EGLO HAT HIERBEI ZWEI SYSTEME ENTWICKELT:
EGLO TRACK PRO: DAS KOMPLEXE LINEARSYSTEM AUS DEM PROFESSIONALSEKTOR FÜR DIE DIY-KUNDEN. HOCHWERTIGE, ROBUSTE MATERIALIEN GARANTIEREN LANGLEBIGE PRODUKTE.
EGLO TRACK BASIC: DAS BEDIENERFREUNDLICHSTE EINPHASENSYSTEM AM MARKT. DIE EGLO TRACKSYSTEME ERMÖGLICHEN AUCH HIER GEZIELTE INSZENIERUNG VON RÄUMEN, FLÄCHEN ODER GEGENSTÄNDEN.
 - > INSGESAMT BIETET DAS NEUE SYSTEM VIELSEITIGE MÖGLICHKEITEN DER ARCHITEKTUR, INTERIEUR ABER AUCH EINZELNE GEGENSTÄNDE INS RICHTIGE LICHT ZU RÜCKEN UND DEN RAUM MIT ATMOSPHERE ZU FÜLLEN.
-

AVANTAGES

- > LES SYSTÈMES DE PHASES LED SONT DE PLUS EN PLUS UTILISÉS DANS LA DÉCORATION INTÉRIEURE : COMME ÉCLAIRAGE PRINCIPAL DANS LES PIÈCES DE VIE OU COMME ÉCLAIRAGE D'APPOINT.
- > LES LUMINAIRES ET LES RAILS À LED SONT PLUS FLEXIBLES QUE TOUTE AUTRE SOURCE DE LUMIÈRE. EGLO A DÉVELOPPÉ DEUX SYSTÈMES.
EGLO TRACK PRO : LE SYSTÈME LINÉAIRE COMPLEXE DU SECTEUR PROFESSIONNEL POUR LES CLIENTS PARTICULIERS. DES MATÉRIAUX ROBUSTES DE HAUTE QUALITÉ GARANTISSENT LA LONGÉVITÉ DES PRODUITS.
EGLO TRACK BASIC : LE SYSTÈME MONOPHASÉ LE PLUS CONVIVIAL DU MARCHÉ. LES SYSTÈMES DE RAILS EGLO PERMETTENT ÉGALEMENT DE METTRE EN AVANT DE MANIÈRE CIBLÉE DES PIÈCES, DES SURFACES OU DES OBJETS.
- > AINSI, CE NOUVEAU SYSTÈME OFFRE DE NOMBREUSES POSSIBILITÉS POUR METTRE EN LUMIÈRE L'ARCHITECTURE, L'INTÉRIEUR OU ENCORE LES OBJETS ET DONNER UNE CERTAINE AMBIANCE À UNE PIÈCE.

OVERVIEW

EGLO TRACK SYSTEM **BASIC**



EGLO TRACK SYSTEM **PRO**

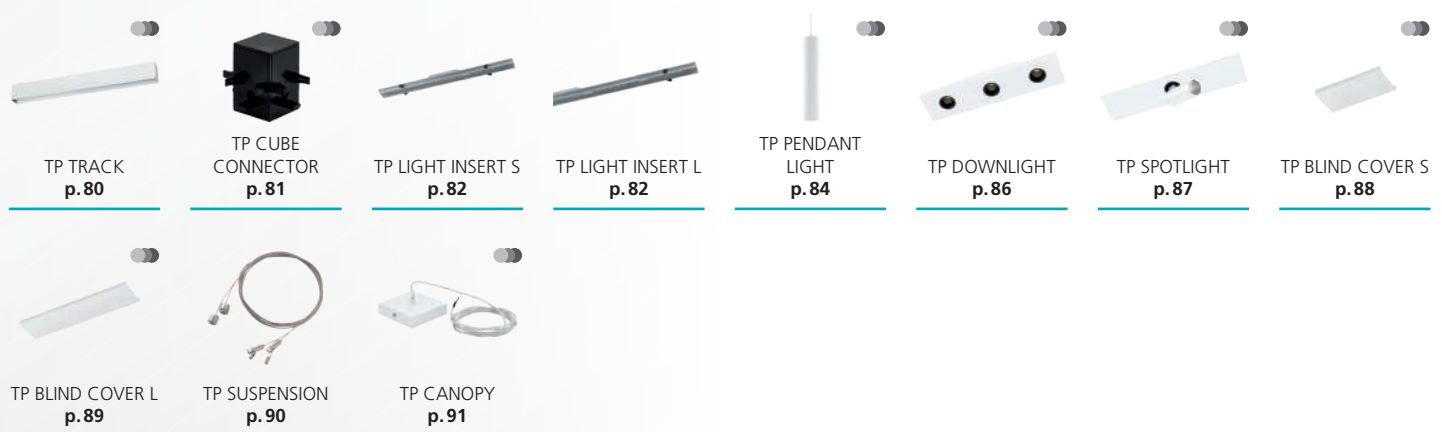

 This product is available in different colors and shapes./ Dieser Artikel ist in unterschiedlichen Farben und Formen verfügbar.
Cet article est disponible en différentes couleurs et formes.

EGLO TRACK SYSTEM

BASIC

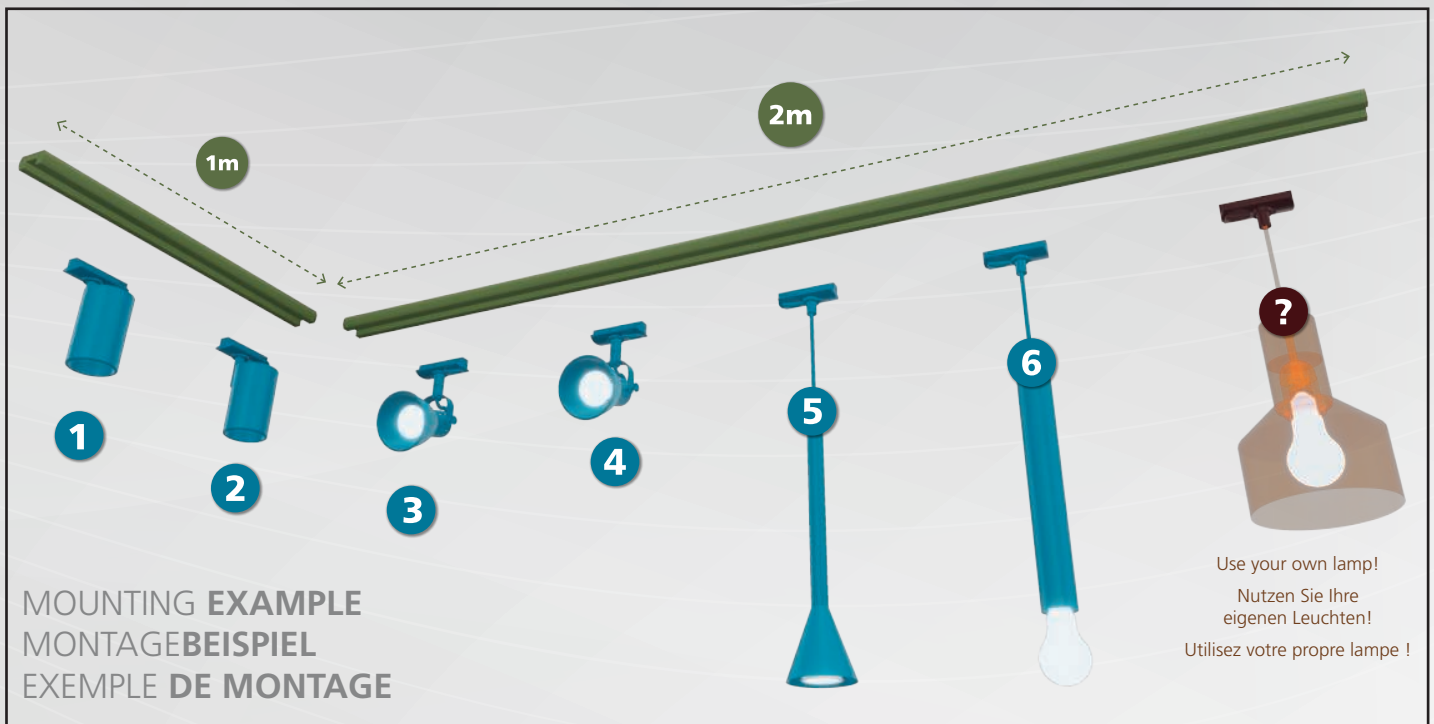

IN GENERAL/ ALLGEMEINES/ CARACTÉRISQUES GÉNÉRALES

- > The most user-friendly product./ Das nutzerfreundlichste Produkt./ Particulièrement ergonomique.
- > Lighting-highlights have been adapted, and are now ready to use with the **BASIC** system./ Die Spots wurden angepasst und können nun mit dem **BASIC**-System verwendet werden./ Les principales propriétés d'éclairage ont été adaptées et peuvent maintenant être utilisées avec le système **BASIC**.
- > Left- and right mounting with flexible **corner-connector**. Use the straight connector to attach the track in line./ Links- und Rechtsmontage mit flexiblem **Eckverbinder**. Verwenden Sie den geraden Verbinder, um die Schienen (Tracks) in Reihe zu verbinden./ Montage à gauche et à droite grâce au **connecteur coudé** flexible. Utilisez le connecteur droit pour fixer le rail en ligne droite.
- > Available in the trend colors:/ verfügbar in den Trendfarben:/ Disponible en deux coloris tendance :

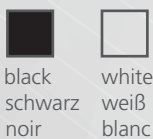

EGLO TRACK **BASIC**

1

You can get the track in two different sizes: 1m + 2m. Install them on the ceiling and connect the tracks (left, right or straight) by using the flexible corner connector.

Sie können die Tracks in zwei verschiedenen Größen erhalten: 1 m + 2 m. Montieren Sie sie an der Decke und verbinden Sie die Tracks mithilfe des flexiblen Eckverbinders nach links, rechts oder geradeaus.

Rail disponible en deux tailles : 1 m + 2 m. Montez-les au plafond et connectez les rails à gauche, à droite ou tout droit à l'aide du connecteur d'angle flexible.

2

Choose your favourite LIGHT FIXTURES by clicking them into the track, easily.

Wählen Sie Ihre bevorzugten Beleuchtungselemente, indem Sie sie einfach in die Schiene einklicken.

Choisissez vos luminaires préférés et clipsez-les facilement dans le rail.

3

Stay flexible – use the adapter to hang a lamp, that you have at home.

Blieben sie flexibel - verwenden Sie den Adapter, um eine bereits vorhandene Leuchte einzuhängen.

Une flexibilité en toutes Circonstances : si vous avez déjà une lampe chez vous, utilisez l'adaptateur pour la suspendre.



ADVANTAGES

- > THE SINGLE-PHASE SYSTEM IS THE MOST USER-FRIENDLY PRODUCT ON THE MARKET.
 - > USE THE EGLO TRACK SYSTEMS TO SET THE SCENE IN A ROOM, SPACE OR AROUND AN OBJECT.
 - > EGLO'S DECORATIVE HIGHLIGHTS FOR LIVING SPACES HAVE BEEN INTEGRATED INTO THE SINGLE-PHASE SYSTEM. AN ADAPTER IS AVAILABLE THAT LETS YOU INTEGRATE YOUR OWN LIGHT FIXTURES INTO THE SYSTEM.
 - > THE LONGITUDINAL CONNECTORS ON THE RAIL SYSTEM MAKE IT SUPERBLY EASY TO EXTEND.
 - > THE SYSTEM ALSO HAS FLEXIBLE CORNER CONNECTORS WITH BALL JOINTS, SO THAT IT CAN EASILY BE INSTALLED ON THE LEFT OR RIGHT.
 - > OUR HANDY STARTER SET PERFECTLY ROUNDS OFF OUR PRODUCT RANGE.
-

VORTEILE

- > DAS EINPHASENSYSTEM IST DAS BEDIENERFREUNDLICHSTE PRODUKT AM MARKT.
 - > DIE EGLO TRACKSYSTEME ERMÖGLICHEN GEZIELTE INSZENIERUNG VON RÄUMEN, FLÄCHEN ODER GEGENSTÄNDEN.
 - > EGLO'S DEKORATIVE HIGHLIGHTS AUS DEM WOHNBEREICH WURDEN IN DAS EINPHASENSYSTEM INTEGRIERT. MIT HILFE DES ADAPTERS KANN MAN EIGENE LEUCHTEN IN DAS SYSTEM EINSPEISEN.
 - > DAS SCHIENENSYSTEM LÄSST SICH MIT DEM LÄNGSVERBINDER KINDERLEICHT VERLÄNGERN.
 - > DER FLEXIBLE ECKVERBINDER MIT KUGELGELENK ERMÖGLICHT EINE EINFACHE LINKS- ODER RECHTSMONTAGE.
 - > DAS PRAKTISCHE EINSTEIGERSET RUNDET DIE PRODUKTPALETTE PERFEKT AB.
-

AVANTAGES

- > LE SYSTÈME MONOPHASÉ EST LE PRODUIT LE PLUS CONVIVAL DU MARCHÉ.
- > LES SYSTÈMES DE RAILS EGLO PERMETTENT UNE MISE EN SCÈNE CIBLÉE DES PIÈCES, DES ESPACES OU DES OBJETS.
- > LES ÉLÉMENTS DÉCORATIFS D'EGLO POUR L'INTÉRIEUR ONT ÉTÉ INTÉGRÉS AU SYSTÈME MONOPHASÉ. GRÂCE À L'ADAPTATEUR, IL EST POSSIBLE D'INTÉGRER SES PROPRES LUMIÈRES AU SYSTÈME.
- > LE SYSTÈME DE RAILS PEUT ÊTRE FACILEMENT ÉTENDU GRÂCE AU CONNECTEUR LONGITUDINAL.
- > LE CONNECTEUR D'ANGLE FLEXIBLE AVEC ROTULE PERMET UN MONTAGE FACILE À GAUCHE OU À DROITE.
- > LE KIT DE DÉMARRAGE PRATIQUE COMPLÈTE PARFAITEMENT LA GAMME DE PRODUITS.



99762

99763

99762 TB SET

system; aluminium, plastic, white / steel, white
 System; Alu, Kunststoff, weiss / Stahl, weiss
 système; aluminium, plastique, blanc / acier, blanc

L 1000

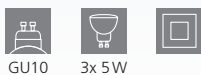

GU10 3x 5W



9 002759 997625



L 1000

99763 TB SET

system; aluminium, plastic, black / steel, black
 System; Alu, Kunststoff, schwarz / Stahl, schwarz
 système; aluminium, plastique, noir / acier, noir

L 1000

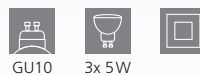

GU10 3x 5W



9 002759 997632



L 1000



99751 TB SPOTLIGHT

spot; plastic, white / steel, white
 Spot; Kunststoff, weiss / Stahl, weiss
 spot; plastique, blanc / acier, blanc

L 80, B 85, H 150



99756 TB SPOTLIGHT

spot; plastic, black / steel, black
 Spot; Kunststoff, schwarz / Stahl, schwarz
 spot; plastique, noir / acier, noir

L 80, B 85, H 150

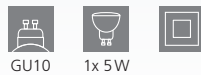



99734



99735

99734, 99735

These items come with a power feed and end cap included.

Diese Artikel enthalten als Zubehör Einspeisung und Endkappe.

Ces articles comprennent l'alimentation et l'embout comme accessoires.

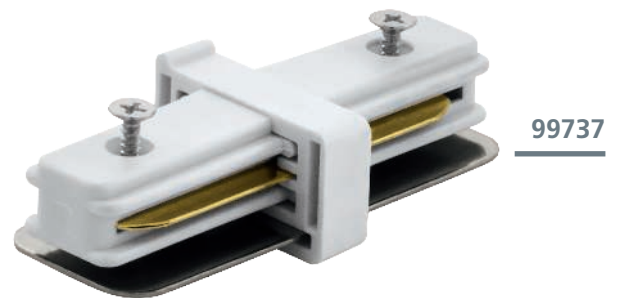

99737

99734 TB TRACK S

accessory; aluminium, white
Zubehör; Alu, weiss
accessoire; aluminium, blanc

L 1000, B 35, H 20

99735 TB TRACK L

accessory; aluminium, white
Zubehör; Alu, weiss
accessoire; aluminium, blanc

L 2000, B 35, H 20

99737 TB CONNECTOR

accessory; plastic, white
Zubehör; Kunststoff, weiss
accessoire; plastique, blanc

L 81, B 35, H 23



9 002759 997342

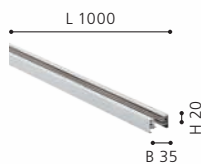

9 002759 997359

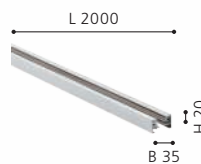

9 002759 997373





99738



99736

99736

Use Your own lamp! With the TB ADAPTER, almost any luminaire can be installed in the track system.

Verwenden Sie Ihre eigene Leuchte! Mit dem TB ADAPTER kann nahezu jede Leuchte im Schienensystem verbaut werden.

Utilisez votre propre luminaire ! Avec le TB ADAPTER, il est possible d'installer pratiquement n'importe quel luminaire dans le système de rails.

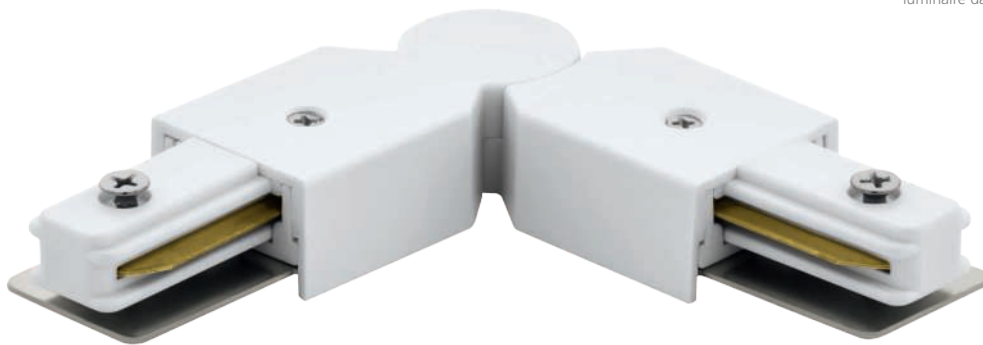
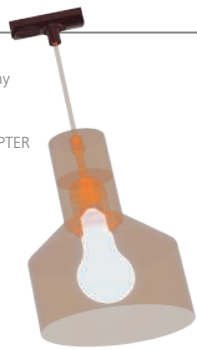

99739

99738 TB MIDDLE FEEDER

accessory; plastic, white
Zubehör; Kunststoff, weiss
accessoire; plastique, blanc

L 143, B 34, H 20

99739 TB CORNER CONNECT

accessory; plastic, white
Zubehör; Kunststoff, weiss
accessoire; plastique, blanc

L 276, B 34, H 20

99736 TB ADAPTER

accessory; plastic, white
Zubehör; Kunststoff, weiss
accessoire; plastique, blanc

L 81, B 35, H 23



9 002759 997380



L 143



9 002759 997397



L 276



9 002759 997366



L 81



99742



99743

99742, 99743

These items come with a power feed and end cap included.

Diese Artikel enthalten als Zubehör Einspeisung und Endkappe.

Ces articles contiennent une alimentation et un embout comme accessoires.



99745

99742 TB TRACK S

accessory; aluminium, black
Zubehör; Alu, schwarz
accessoire; aluminium, noir

L 1000, B 35, H 20

99743 TB TRACK L

accessory; aluminium, black
Zubehör; Alu, schwarz
accessoire; aluminium, noir

L 2000, B 35, H 20

99745 TB CONNECTOR

accessory; plastic, black
Zubehör; Kunststoff, schwarz
accessoire; plastique, noir

L 81, B 35, H 23



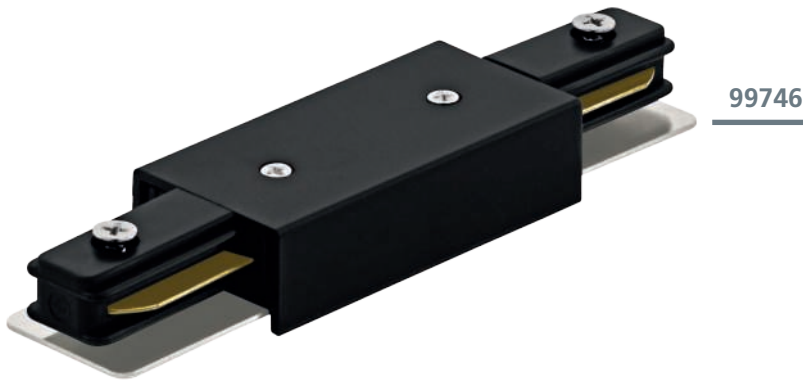

99746



99744

99744

Use Your own lamp! With the TB ADAPTER, almost any luminaire can be installed in the track system.

Verwenden Sie Ihre eigene Leuchte! Mit dem TB ADAPTER kann nahezu jede Leuchte im Schienensystem verbaut werden.

Utilisez votre propre luminaire ! Avec le TB ADAPTER, il est possible d'installer pratiquement n'importe quel luminaire dans le système de rails.

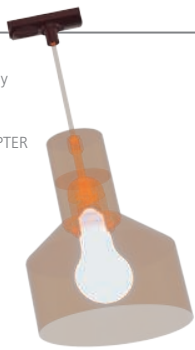

99747

99746 TB MIDDLE FEEDER

accessory; plastic, black
Zubehör; Kunststoff, schwarz
accessoire; plastique, noir

L 143, B 34, H 20

99747 TB CORNER CONNECT

accessory; plastic, black
Zubehör; Kunststoff, schwarz
accessoire; plastique, noir

L 276, B 34, H 20

99744 TB ADAPTER

accessory; plastic, black
Zubehör; Kunststoff, schwarz
accessoire; plastique, noir

L 81, B 35, H 23



9 002759 997465



L 143



9 002759 997472



L 276



9 002759 997441



L 81



99761



99757



99753

99761 TB NEWTOWN

pendant light; plastic, black / steel, black
 Hängeleuchte; Kunststoff, schwarz / Stahl, schwarz
 luminaire en suspension; plastique, noir / acier, noir

H 1100, Ø 160

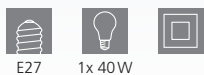

E27 1x 40W



9 002759 997618



99757 TB CASIBARE

pendant light; plastic, black / steel, black
 Hängeleuchte; Kunststoff, schwarz / Stahl, schwarz
 luminaire en suspension; plastique, noir / acier, noir

H 1100, Ø 150

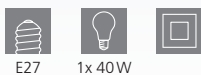

E27 1x 40W



9 002759 997571



99753 TB CORTENOVA

pendant light; plastic, white / steel, white
 Hängeleuchte; Kunststoff, weiss / Stahl, weiss
 luminaire en suspension; plastique, blanc / acier, blanc

H 1100, Ø 40



E27 1x 40W



9 002759 997533

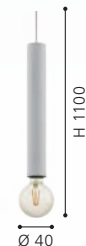



99758



99754



99759

99753, 99757, 99758, 99761

Adapter included.

Inklusive Adapter.

Adapteur inclus.

99758 TB CORTENOVA

pendant light; plastic, black / steel, black
 Hängeleuchte; Kunststoff, schwarz / Stahl, schwarz
 luminaire en suspension; plastique, noir / acier, noir

H 1100, Ø 40



E27 1x 40W



9 002759 997588



99754 TB CORTADERAS

pendant light; plastic, white / steel, white
 Hängeleuchte; Kunststoff, weiss / Stahl, weiss
 luminaire en suspension; plastique, blanc / acier, blanc

H 1500, Ø 85

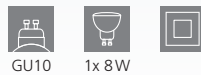

GU10 1x 8W



9 002759 997540



99759 TB CORTADERAS

pendant light; plastic, black / steel, black
 Hängeleuchte; Kunststoff, schwarz / Stahl, schwarz
 luminaire en suspension; plastique, noir / acier, noir

H 1500, Ø 85



GU10 1x 8W



9 002759 997595

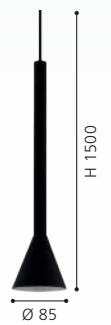



99749



99764



99765

99764 TB BUZZ

spot; plastic, white / steel, white
 Spot; Kunststoff, weiss / Stahl, weiss
 spot; plastique, blanc / acier, blanc

L 100, H 75



GU10 1x 3W



99765 TB BUZZ

spot; plastic, black / steel, black
 Spot; Kunststoff, schwarz / Stahl, schwarz
 spot; plastique, noir / acier, noir

L 100, H 75



GU10 1x 3W





99749



99755

99749 TB SERAS

spot; plastic, white / steel, white
 Spot; Kunststoff, weiss / Stahl, weiss
 spot; plastique, blanc / acier, blanc

H 165, Ø 85



GU10 1x 35W



99755 TB SERAS

spot; plastic, black / steel, black
 Spot; Kunststoff, schwarz / Stahl, schwarz
 spot; plastique, noir / acier, noir

H 165, Ø 85

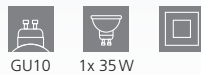

GU10 1x 35W



EGLO TRACK SYSTEM

PRO

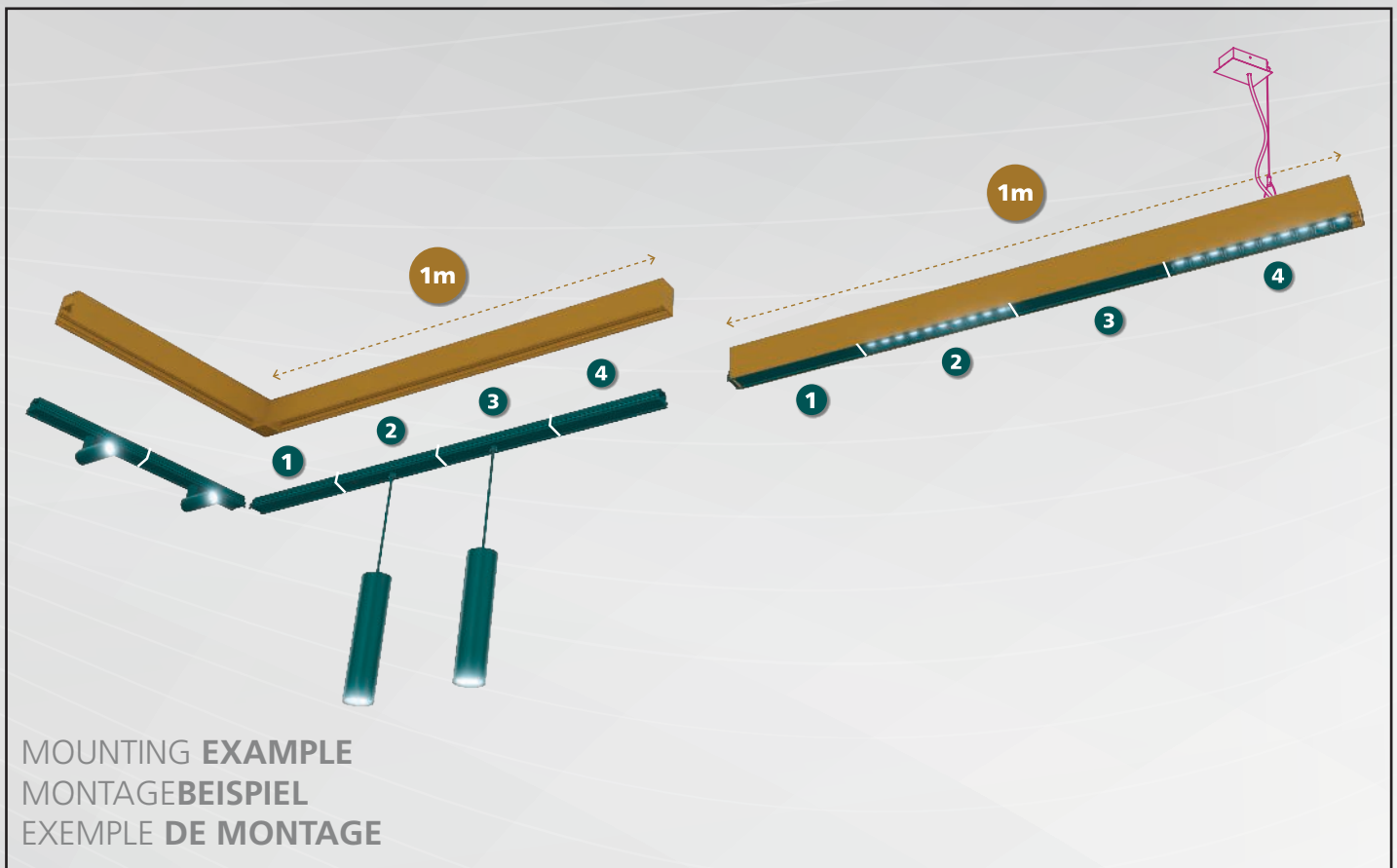

IN GENERAL/ ALLGEMEINES/ CARACTÉRISQUES GÉNÉRALES

- > The track has already installed a 24V driver and includes two endcovers and two connectors./ Die Schiene hat bereits einen 24V-Trafo installiert und enthält zwei Endabdeckungen und zwei Anschlüsse./ Le rail est équipé d'un driver 24 V et inclut deux embouts et deux connecteurs.
- > Mount it easily around corners with the connection cube./ Kann mit dem Verbindungswürfel leicht über das Eck montiert werden./ Peut être facilement monté dans les coins grâce au domino de raccordement.
- > Can be fixed on the ceiling or optionally suspended./ Kann an der Decke oder optional abhängig befestigt werden./ Peut être fixé au plafond ou suspendu en option devenir.
- > All products in 3 different colors./ Alle Produkte in 3 verschiedenen Farben erhältlich./ Tous les produits sont disponibles en 3 coloris différents :

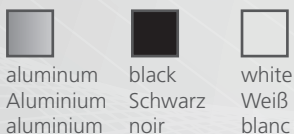

EGLO TRACK PRO

1

You can fix as many rails as you want next to each other. Size: 1062,5 mm.

Sie können beliebig viele Tracks hintereinander befestigen. Größe: 1062,5 mm.

Vous pouvez fixer autant de rails que vous le souhaitez les uns à côté des autres. Taille : 1 062,5 mm.

2

1 Track = max. 4 modules: choose out of 4 spotsolutions or use the end-to-end light insert for a complete illumination.

1 Track = max. 4 Module: Wählen Sie aus 4 Spot-Lösungen oder verwenden Sie den durchgängigen Leuchteinsatz für eine komplette Ausleuchtung.

1 rail = 4 modules maximum : choisissez parmi 4 solutions de spots ou utilisez un insert lumineux de bout en bout pour un éclairage complet.

3

Use the appropriate accessories to get the most out of the track PRO system.

Verwenden Sie das entsprechende Zubehör, um das Track PRO-System optimal zu nutzen.

Utilisez les accessoires appropriés pour tirer le meilleur parti de votre système de rail PRO.



ADVANTAGES

- > WE'VE TAKEN THE FLEXIBLE LINEAR SYSTEM FROM THE TRADE SECTOR AND REDESIGNED IT FOR DIY CUSTOMERS.
 - > WE USE HIGH-QUALITY, ROBUST MATERIALS TO ENSURE A LONG SERVICE LIFE.
 - > ALL OUR RAILS INCLUDE A 24V DRIVER. EACH RAIL HAS ROOM FOR UP TO FOUR LIGHT INSERTS. THE LIGHT INSERTS ARE AVAILABLE IN TWO LENGTHS.
 - > THE SYSTEM CAN BE EXTENDED PRACTICALLY AND UNOBTRUSIVELY IN ALL DIRECTIONS USING A CONNECTING CUBE.
 - > INSTALL THE SYSTEM EITHER DIRECTLY ON THE CEILING OR SUSPENDED, AS PREFERRED.
 - > THE LIGHT INSERTS HAVE BEEN DESIGNED TO HARMONISE WITH THE SYSTEM FOR AN ELEGANT, TIMELESS EFFECT.
-

VORTEILE

- > DAS VIELSEITIGE LINEARSYSTEM AUS DEM PROFESSIONAL BEREICH - NUN FÜR DEN DIY MARKT KONZIPIERT.
 - > HOCHWERTIGE, ROBUSTE MATERIALIEN GARANTIEREN LANGLEBIGE PRODUKTE. ALLE SCHIENEN HABEN EINEN 24V TREIBER VERBAUT.
 - > JEDE SCHIENE BIETET PLATZ FÜR BIS ZU 4 LICHTEINSÄTZE. DIE LICHEINSÄTZE SIND IN ZWEI VERSCHIEDENEN LÄNGEN ERHÄLTlich.
 - > EIN VERBINDUNGSWÜRFEL ERMÖGLICHT EINE DEZENTE UND UNAUFFÄLLIGE ERWEITERUNG IN ALLE RICHTUNGEN.
 - > DAS SYSTEM KANN ENTWEDER DIREKT AN DER DECKE ODER WAHLWEISE ABGEHÄNGENT MONTIERT WERDEN.
 - > DAS STIMMIGE DESIGN DER LICHTEINSÄTZE WIRKT ELEGANT UND ZEITLOS.
-

AVANTAGES

- > LE SYSTÈME LINÉAIRE POLYVALENT DE LA GAMME PROFESSIONNELLE - DÉSORMAIS CONÇU POUR LE MARCHÉ DES PARTICULIERS.
- > DES MATÉRIAUX ROBUSTES DE HAUTE QUALITÉ GARANTISSENT LA LONGÉVITÉ DES PRODUITS.
- > TOUS LES RAILS SONT DOTÉS D'UN DRIVER 24 V. CHAQUE RAIL PEUT ACCUEILLIR JUSQU'À 4 INSERTS LUMINEUX. LES INSERTS LUMINEUX SONT DISPONIBLES EN DEUX LONGUEURS DIFFÉRENTES.
- > UN DOMINO DE RACCORDEMENT PERMET UNE EXTENSION DISCRÈTE DANS TOUTES LES DIRECTIONS.
- > LE SYSTÈME PEUT ÊTRE MONTÉ DIRECTEMENT AU PLAFOND OU SUSPENDU.
- > LES INSERTS LUMINEUX ONT UN DESIGN ÉLÉGANT ET INTEMPOREL.



98821



98822

TP TRACK

24V driver included.

Inklusive 24V Treiber.

Pilote 24V inclus.

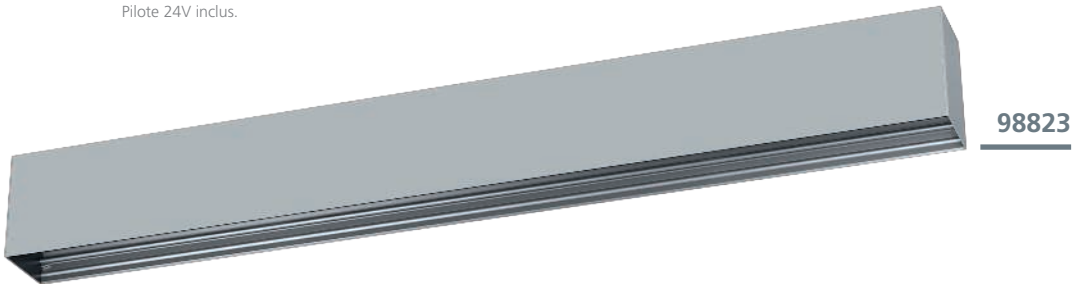

98823

98821 TP TRACK

system; aluminium, black
System; Alu, schwarz
système; aluminium, noir

L 1144, B 46, H 68



98822 TP TRACK

system; aluminium, white
System; Alu, weiss
système; aluminium, blanc

L 1144, B 46, H 68



98823 TP TRACK

system; aluminium, anodised aluminium
System; Alu, alu eloxiert
système; aluminium, aluminium anodisé

L 1144, B 46, H 68



9 002759 988210



L 1144

H 68



9 002759 988227



L 1144

H 68



9 002759 988234



L 1144

H 68



TP CUBE CONNECTOR

Included accessories for use as corner connectors, T-connector and cross connector.

Durch enthaltenes Zubehör für den Einsatz als Eckverbinder, T-Verbinder und Kreuzverbinder geeignet.

Convient à l'utilisation comme connecteur d'angle, connecteur en T et connecteur en croix grâce aux accessoires inclus.

98801



98802

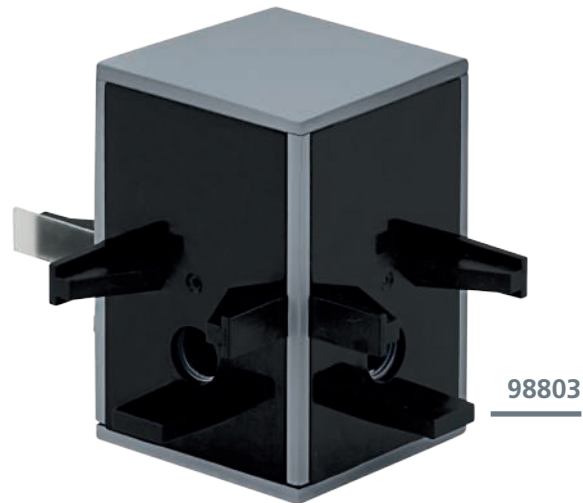

98803

98801 TP CUBE CONNECTOR

accessory; plastic, aluminium, black
Zubehör; Kunststoff, Alu, schwarz
accessoire; plastique, aluminium, noir

L 61, B 76, H 68

98802 TP CUBE CONNECTOR

accessory; plastic, aluminium, black, white
Zubehör; Kunststoff, Alu, schwarz, weiss
accessoire; plastique, aluminium, noir, blanc

L 61, B 76, H 68

98803 TP CUBE CONNECTOR

accessory; plastic, aluminium, black, anodised aluminium
Zubehör; Kunststoff, Alu, schwarz, alu eloxiert
accessoire; plastique, aluminium, noir, aluminium anodisé

L 61, B 76, H 68



9 002759 988012

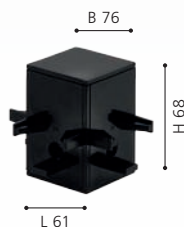

9 002759 988029

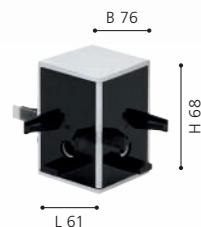

9 002759 988036

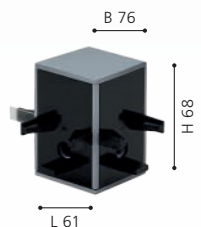

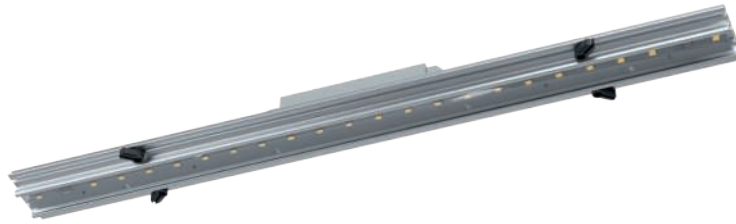

98808



98809



TP LIGHT INSERT S

Diffuser cover included in the scope of delivery.
 Diffusor-Abdeckung im Lieferumfang enthalten.
 Couverture du diffuseur incluse dans la livraison.

98808 TP LIGHT INSERT S

system; aluminium, aluminium / plastic, white
 System; Alu, alu / Kunststoff, weiss
 système; aluminium, aluminium / plastique, blanc

L 285, B 46, H 39



98809 TP LIGHT INSERT L

system; aluminium, aluminium / plastic, white
 System; Alu, alu / Kunststoff, weiss
 système; aluminium, aluminium / plastique, blanc

L 1140, B 46, H 39



9 002759 988081



9 002759 988098

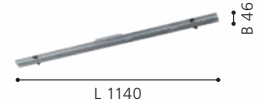



98808





98811

LED



98812

LED



98813

LED



TP PENDANT LIGHT

Track insert included.

Inklusive Schieneneinsatz.

Insert de rail inclus.

98811 TP PENDANT LIGHT

pendant light; aluminium, plastic, black
Hängeleuchte; Alu, Kunststoff, schwarz
luminaire en suspension; aluminium, plastique, noir

L 285, B 44, H 2015, Ø 40



1x 8,5W 1200lm



9 002759 988111



Ø 40

98812 TP PENDANT LIGHT

pendant light; aluminium, plastic, white
Hängeleuchte; Alu, Kunststoff, weiss
luminaire en suspension; aluminium, plastique, blanc

L 285, B 44, H 2015, Ø 40



1x 8,5W 1200lm



9 002759 988128



Ø 40

98813 TP PENDANT LIGHT

pendant light; aluminium, plastic, anodised aluminium
Hängeleuchte; Alu, Kunststoff, alu eloxiert
luminaire en suspension; aluminium, plastique, aluminium anodisé

L 285, B 44, H 2015, Ø 40



1x 8,5W 1200lm



9 002759 988135



Ø 40



98811

LED



98814



98815



98816



98814 TP DOWNLIGHT

system; aluminium, plastic, black
System; Alu, Kunststoff, schwarz
système; aluminium, plastique, noir

L 285, B 44, H 34



3x 3,5W 1350lm



9 002759 988142



98815 TP DOWNLIGHT

system; aluminium, plastic, white
System; Alu, Kunststoff, weiss
système; aluminium, plastique, blanc

L 285, B 44, H 34



3x 3,5W 1350lm



9 002759 988159

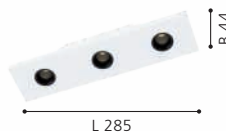

98816 TP DOWNLIGHT

system; aluminium, plastic, anodised aluminium
System; Alu, Kunststoff, alu eloxiert
système; aluminium, plastique, aluminium anodisé

L 285, B 44, H 34



3x 3,5W 1350lm



9 002759 988166

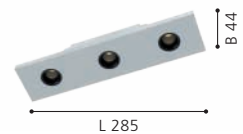



98817



98818

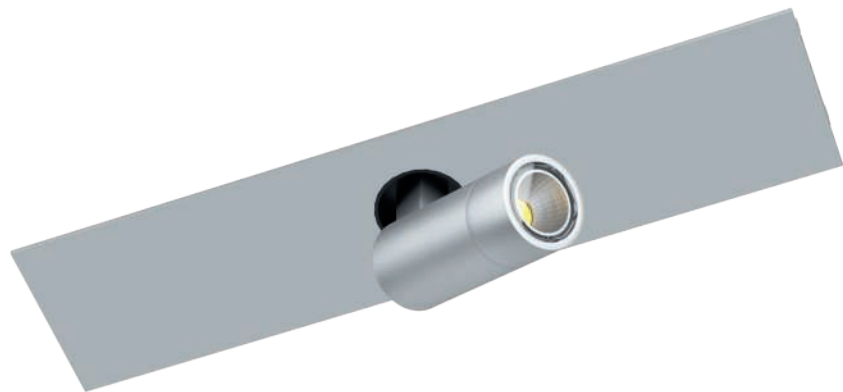

98819



98817 TP SPOTLIGHT

system; aluminium, plastic, black
System; Alu, Kunststoff, schwarz
système; aluminium, plastique, noir

L 285, B 44, H 95



1x 8,5W 1200lm



9 002759 988173



L 285

98818 TP SPOTLIGHT

system; aluminium, plastic, white
System; Alu, Kunststoff, weiss
système; aluminium, plastique, blanc

L 285, B 44, H 95



1x 8,5W 1200lm



9 002759 988180



L 285

98819 TP SPOTLIGHT

system; aluminium, plastic, anodised aluminium
System; Alu, Kunststoff, alu eloxiert
système; aluminium, plastique, aluminium anodisé

L 285, B 44, H 95



1x 8,5W 1200lm



9 002759 988197



L 285



98824 TP BLIND COVER S

accessory; aluminium, black
Zubehör; Alu, schwarz
accessoire; aluminium, noir

L 142, B 44, H 14

98825 TP BLIND COVER S

accessory; aluminium, white
Zubehör; Alu, weiss
accessoire; aluminium, blanc

L 142, B 44, H 14

98826 TP BLIND COVER S

accessory; aluminium, anodised aluminium
Zubehör; Alu, alu eloxiert
accessoire; aluminium, aluminium anodisé

L 142, B 44, H 14

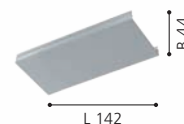

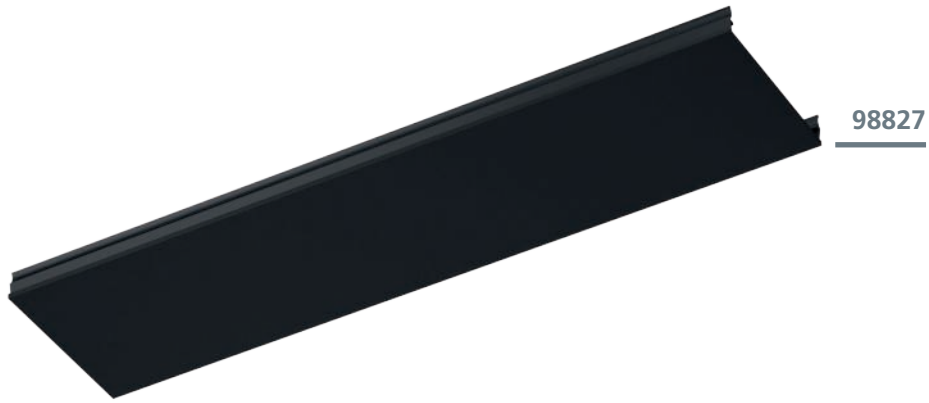

98827



98828



98829

98827 TP BLIND COVER L

accessory; aluminium, black
 Zubehör; Alu, schwarz
 accessoire; aluminium, noir

L 285, B 44, H 14

98828 TP BLIND COVER L

accessory; aluminium, white
 Zubehör; Alu, weiss
 accessoire; aluminium, blanc

L 285, B 44, H 14

98829 TP BLIND COVER L

accessory; aluminium, anodised aluminium
 Zubehör; Alu, alu eloxiert
 accessoire; aluminium, aluminium anodisé

L 285, B 44, H 14

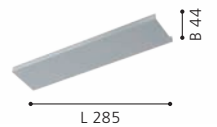
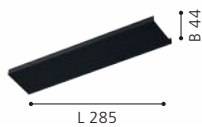



98804

98807



98804

98804 TP SUSPENSION

accessory; steel, silver
Zubehör; Stahl, silber
accessoire; acier, argent

H 2035, Ø 15





98806



98805



98807

98805 TP CANOPY

accessory; steel, plastic, black
Zubehör; Stahl, Kunststoff, schwarz
accessoire; acier, plastique, noir

L 110, B 110, H 2025

98806 TP CANOPY

accessory; steel, plastic, white
Zubehör; Stahl, Kunststoff, weiss
accessoire; acier, plastique, blanc

L 110, B 110, H 2025

98807 TP CANOPY

accessory; steel, plastic, silver
Zubehör; Stahl, Kunststoff, silber
accessoire; acier, plastique, argent

L 110, B 110, H 2025



H 2025



H 2025

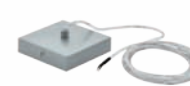

H 2025



LED PANEL

LUMINAIRES

ADVANTAGES

- > SURFACE LIGHT - CLEAR LINES AND FLAT DESIGN
 - > ENERGY-EFFICIENT AND COST-SAVING THANKS TO LED TECHNOLOGY
 - > MULTIPLE APPLICATION POSSIBILITIES: LIVING ROOM, BEDROOM, HOME OFFICE, KITCHEN, CELLAR, WORK SURFACES, HALLWAY AND MUCH MORE.
 - > MODERN TECHNOLOGY
 - > FUNCTIONS FROM ON/OFF TO RGBW
 - > DIFFERENT MATERIALS - METAL, REAL WOOD AND PLASTIC
-

VORTEILE

- > FLÄCHENLICHT - KLARE LINIEN UND FLACHE BAUFORM
 - > ENERGIEEFFIZIENT UND KOSTENSPAREND DURCH LED-TECHNOLOGIE
 - > DIVERSE EINSATZMÖGLICHKEITEN: WOHNZIMMER, SCHLAFZIMMER, HOMEOFFICE, KÜCHE, KELLER, ARBEITSFLÄCHEN, FLUR, UVM.
 - > MODERNE TECHNIK
 - > FUNKTIONEN VON ON/OFF BIS RGBW
 - > VERSCHIEDENE MATERIALIEN - METALL, ECHTHOLZ UND KUNSTSTOFF
-

AVANTAGES

- > ÉCLAIRAGE DE SURFACE - LIGNES CLAIRES ET DESIGN PLAT
- > EFFICACITÉ ÉNERGÉTIQUE ET ÉCONOMIE DE COÛTS GRÂCE À LA TECHNOLOGIE LED
- > MULTIPLES POSSIBILITÉS D'UTILISATION : SALON, CHAMBRE À COUCHER, BUREAU À DOMICILE, CUISINE, CAVE, PLANS DE TRAVAIL, COULOIR ET BIEN PLUS ENCORE.
- > TECHNOLOGIE MODERNE
- > FONCTIONS DE ON/OFF À RGBW
- > DIFFÉRENTS MATÉRIAUX - MÉTAL, BOIS VÉRITABLE ET PLASTIQUE



LED PANEL FUNCTION

Item Number Artikelnummer Numéro d'article	Series name Seriename Nom de la série	Dimensions Größe Dimensions	Page Seite Page	warm white warmweiß blanc chaud	neutral white neutralweiß blanc neutre	dimmbable dimmbar gradable
99728	URTEBIETA	L 595, B 595, H 50	100	•	•	
99729	URTEBIETA	L 1195, B 295, H 50	100		•	
32812	SALOBRENA 1	L 300, B 300, H 50	102		•	
98129	SALOBRENA 1	L 450, B 450, H 50	102		•	
32811	SALOBRENA 1	L 1200, B 300, H 50	103		•	
32813	SALOBRENA 1	L 595, B 595, H 50	103		•	
98025	SALOBRENA 1	L 1195, B 100, H 45	103		•	
98418	SALOBRENA-M	L 595, B 595, H 50	104		•	
98419	SALOBRENA-M	L 1195, B 295, H 50	104		•	
97501	SARSINA	H 50, Ø 300	106		•	•
97502	SARSINA	H 50, Ø 450	106		•	•
97503	SARSINA	H 50, Ø 600	106		•	•
98485	SARSINA	H 50, Ø 800	107		•	•
33107	SALOBRENA-RGBW	L 450, B 450, H 11	108	•	•	•
33108	SALOBRENA-RGBW	L 600, B 300, H 11	108	•	•	•
96152	SALOBRENA 1	L 300, B 300, H 11	110		•	
96153	SALOBRENA 1	L 595, B 595, H 11	110		•	
96154	SALOBRENA 1	L 620, B 620, H 11	110		•	
96151	SALOBRENA 1	L 1200, B 300, H 11	111		•	
900703	TURCONA-B	L 287, B 287, H 62	116		•	
900704	TURCONA-B	L 437, B 437, H 70	116		•	
900705	TURCONA-B	L 587, B 587, H 70	117		•	
900706	TURCONA-B	L 1187, B 287, H 70	117		•	
99843	TURCONA-B	L 287, B 287, H 62	118	•		
99844	TURCONA-B	L 437, B 437, H 70	118	•		
99845	TURCONA-B	L 587, B 587, H 70	118	•		
900707	TURCONA-B	L 1200, B 100, H 70	117		•	
900708	TURCONA-B	L 1200, B 100, H 70	119	•		
99846	TURCONA-B	L 1187, B 287, H 70	119	•		
99833	TURCONA-CCT	L 287, B 287, H 62	120	•	•	•
99834	TURCONA-CCT	L 437, B 437, H 70	121	•	•	•
99835	TURCONA-CCT	L 587, B 587, H 70	121	•	•	•
99836	TURCONA-CCT	L 1187, B 287, H 70	121	•	•	•
900568	TRUPIANA	L 437, B 437, H 62	122	•	•	•
900569	TRUPIANA	L 587, B 587, H 62	122	•	•	•

frameless rahmenlos sans cadre	Ceiling mount Deckenmontage Montage au plafond	Inlay panel Einlegepanel Panneau d'incrustation	Suspension Abhängung Suspension	Motion sensor Bewegungssensor Capteur de mouvement	Remote control Fernbedienung Télécommande	RGB RGB RGB
	•					
	•	•				
	•	•				
	•	•				
	•	•				
	•	•				
	•	•		•		
	•	•		•		
	•					
	•					
	•					
	•					
	•				•	
	•				•	
	•	•	•			
	•	•	•			
	•	•	•			
	•	•	•			
•	•					
•	•					
•	•					
•	•					
•	•					
•	•					
•	•					
•	•					
•	•					
•	•					
•	•					
•	•				•	
•	•				•	
•	•				•	
•	•				•	
•	•				•	•
•	•				•	•

LED PANEL FUNCTION

Item Number Artikelnummer Numéro d'article	Series name Seriename Nom de la série	Dimensions Größe Dimensions	Page Seite Page	warm white warmweiß blanc chaud	neutral white neutralweiß blanc neutre	dimnable dimmbar gradable
98901	TURCONA	L 300, B 300, H 60	124		•	
98902	TURCONA	L 450, B 450, H 60	124		•	
98903	TURCONA	L 595, B 595, H 60	124		•	
98904	TURCONA	L 1200, B 300, H 60	125		•	
98905	TURCONA	L 1200, B 100, H 60	125		•	
900571	BORDONARA	L 450, B 450	128	•	•	•
900572	BORDONARA	L 595, B 595	128	•	•	•
900573	BORDONARA	L 1195, B 295	128	•	•	•
900558	MARMORATA	H 70, Ø 450	130	•		
900559	MARMORATA	L 445, B 445	130	•		
900561	MARMORATA	L 595, B 295	130	•		
99038	SAVATARILA	L 450, B 450, H 60	132		•	
99039	SAVATARILA	L 595, B 595, H 60	132		•	
99841	LAZARAS	H 55, Ø 450	133	•	•	•
99842	LAZARAS	L 450, B 450, H 60	133	•	•	•
99435	PIGLIONASSO	L 500, B 500, H 55	136		•	
99436	PIGLIONASSO	L 645, B 645, H 55	136		•	
99437	PIGLIONASSO	L 1245, B 345, H 55	136		•	
99471	PIGLIONASSO	L 500, B 500, H 55	137		•	
99472	PIGLIONASSO	L 645, B 645, H 55	137		•	
99473	PIGLIONASSO	L 1245, B 345, H 55	137		•	
99474	PIGLIONASSO	L 500, B 500, H 55	138		•	
99475	PIGLIONASSO	L 645, B 645, H 55	138		•	
99476	PIGLIONASSO	L 1245, B 345, H 55	138		•	

frameless rahmenlos sans cadre	Ceiling mount Deckenmontage Montage au plafond	Inlay panel Einlegepanel Panneau d'incrustation	Suspension Abhängung Suspension	Motion sensor Bewegungssensor Capteur de mouvement	Remote control Fernbedienung Télécommande	RGB RGB RGB
•	•					
•	•					
•	•					
•	•					
•	•					
	•				•	•
	•				•	•
	•				•	•
	•					
	•					
	•					
	•					
	•					•
	•					•
	•					
	•					
	•					
	•					
	•					
	•					
	•					
	•					
	•					
	•					
	•					



LED PANEL LUMINAIRES

WITH FRAME

ADVANTAGES

- > SURFACE LIGHT WITH SHADOWLESS LIGHTING
 - > ULTRA-FLAT DESIGN
 - > HOMOGENEOUS SURFACE LIGHTING
 - > SIMPLE INSTALLATION
 - > ELEGANT SUSPENSION FRAME INCLUDED
 - > ALSO FOR FLUSH MOUNTING SUITABLE
-

VORTEILE

- > FLÄCHIGES LICHT MIT SCHATTENFREIER AUSLEUCHTUNG
 - > ULTRAFLACHES DESIGN
 - > HOMOGENE FLÄCHENAUSLEUCHTUNG
 - > EINFACHE MONTAGE
 - > INKL. ELEGANTEM SCHWEBERAHMEN
 - > AUCH FÜR FLÄCHENBÜNDIGEN EINBAU GEEIGNET
-

AVANTAGES

- > ÉCLAIRAGE ÉTALÉ AVEC ÉCLAIREMENT
- > SANS OMBRE
- > DESIGN ULTRA PLAT
- > ÉCLAIRAGE DE SURFACE HOMOGENÈ
- > MONTAGE SIMPLE
- > BÂTI FLOTTANT ÉLÉGANT INCLUS ADAPTÉ AU MONTAGE ENCASTRÉ



OVERVIEW



ACCESSORIES INCLUDED

All luminaires including Suspension frame
Alle Leuchten inklusive Schweberahmen
Tous les luminaires inclus bâti flottant

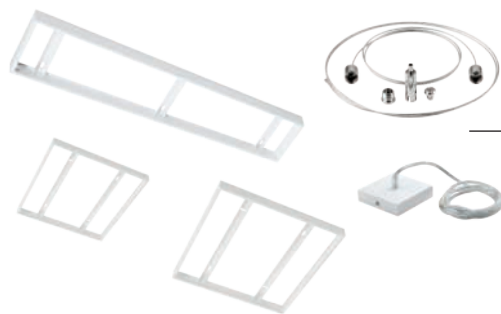

ACCESSORIES OPTIONAL

PAGE / SEITE / PAGE **112-113**



This product is available in different colors and shapes./ Dieser Artikel ist in unterschiedlichen Farben und Formen verfügbar.
Cet article est disponible en différentes couleurs et formes.



99728



99729



99729

Due to its reduced glare effect, this luminaire is very well suited for the home office.

Diese Leuchte ist aufgrund ihres reduzierten Blendeffekts sehr gut für das Homeoffice geeignet.

En raison de son effet d'éblouissement réduit, ce luminaire est très bien adapté au bureau à domicile.

99728 URTEBIETA

ceiling light; steel, white / plastic, white
Deckenleuchte; Stahl, weiss / Kunststoff, weiss
plafonnier; acier, blanc / plastique, blanc

L 595, B 595, H 50



32W 4700lm

99729 URTEBIETA

ceiling light; steel, white / plastic, white
Deckenleuchte; Stahl, weiss / Kunststoff, weiss
plafonnier; acier, blanc / plastique, blanc

L 1195, B 295, H 50



32W 4700lm



9 002759 997281

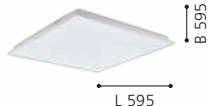

9 002759 997298





99729

LED





98129

LED



32812

LED



98129

LED

32812 SALOBRENA 1

ceiling light; aluminium, steel, white / plastic, white
Deckenleuchte; Alu, Stahl, weiss / Kunststoff, weiss
plafonnier; aluminium, acier, blanc / plastique, blanc

L 300, B 300, H 50



14W 2000lm

98129 SALOBRENA 1

ceiling light; aluminium, white / plastic, white
Deckenleuchte; Alu, weiss / Kunststoff, weiss
plafonnier; aluminium, blanc / plastique, blanc

L 450, B 450, H 50



21W 2700lm



9 002759 328122

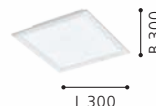

9 002759 981297

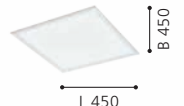



32813

LED



32811

LED



98025

LED

32813 SALOBRENA 1

ceiling light; aluminium, steel, white / plastic, white
Deckenleuchte; Alu, Stahl, weiss / Kunststoff, weiss
plafonnier; aluminium, acier, blanc / plastique, blanc

L 595, B 595, H 50



33W 4700lm

32811 SALOBRENA 1

ceiling light; aluminium, steel, white / plastic, white
Deckenleuchte; Alu, Stahl, weiss / Kunststoff, weiss
plafonnier; aluminium, acier, blanc / plastique, blanc

L 1200, B 300, H 50



33W 4700lm

98025 SALOBRENA 1

ceiling light; aluminium, white / plastic, white
Deckenleuchte; Alu, weiss / Kunststoff, weiss
plafonnier; aluminium, blanc / plastique, blanc

L 1195, B 100, H 45



38W 4700lm



9 002759 328139

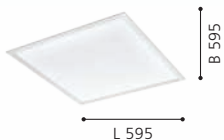

L 595



9 002759 328115

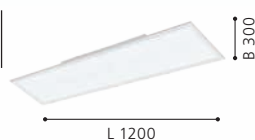

L 1200



9 002759 980252



L 1195



98418



12 m
5 sec. - 15 min.

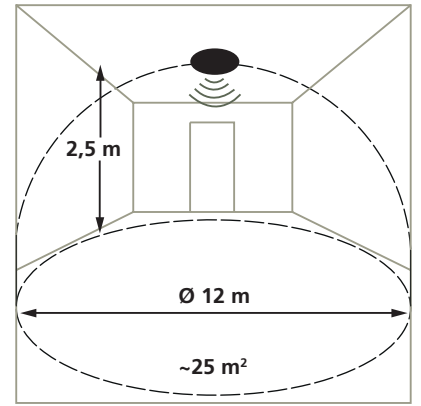

time: 5 sec. - 15 min.



98419



12 m
5 sec. - 15 min.

98418 SALOBRENA-M

ceiling light; aluminium, white / plastic, white
Deckenleuchte; Alu, weiss / Kunststoff, weiss
plafonnier; aluminium, blanc / plastique, blanc

L 595, B 595, H 50



35W 4600lm

98419 SALOBRENA-M

ceiling light; aluminium, white / plastic, white
Deckenleuchte; Alu, weiss / Kunststoff, weiss
plafonnier; aluminium, blanc / plastique, blanc

L 1195, B 295, H 50



35W 5000lm

SALOBRENA-M

These luminaires come with an integrated motion sensor. The sensor is not visible.

Diese Leuchten sind mit einem integrierten Bewegungssensor ausgestattet. Der Sensor ist nicht sichtbar.

Ces luminaires viennent avec un capteur de mouvement intégré. Le capteur n'est pas visible.



9 002759 984182

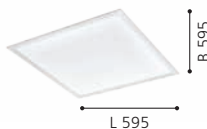

9 002759 984199



98419



12 m
5 sec. - 15 min.



3



2



1



97501



97502



97503



97501 SARSINA

ceiling light; aluminium, white / plastic, white
Deckenleuchte; Alu, weiss / Kunststoff, weiss
plafonnier; aluminium, blanc / plastique, blanc

H 50, Ø 300



17W 2100lm

97502 SARSINA

ceiling light; aluminium, white / plastic, white
Deckenleuchte; Alu, weiss / Kunststoff, weiss
plafonnier; aluminium, blanc / plastique, blanc

H 50, Ø 450



28W 3800lm

97503 SARSINA

ceiling light; aluminium, white / plastic, white
Deckenleuchte; Alu, weiss / Kunststoff, weiss
plafonnier; aluminium, blanc / plastique, blanc

H 50, Ø 600



36W 5400lm



9 002759 975012

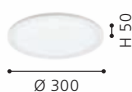

9 002759 975029

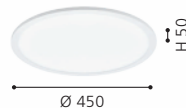

9 002759 975036

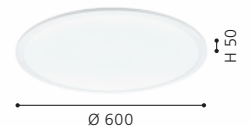



98485



98485



98485 SARSINA

ceiling light; aluminium, white / plastic, white
Deckenleuchte; Alu, weiss / Kunststoff, weiss
plafonnier; aluminium, blanc / plastique, blanc

H 50, Ø 800

LED

neutral
WHITE



4x 9,2W 4800lm



9 002759 984854



Ø 800

H 50



33107



incl./inkl./inclus



33108



incl./inkl./inclus

33107 SALOBRENA-RGBW

grid light; aluminium, white / plastic, white
 Rasterleuchte; Alu, weiss / Kunststoff, weiss
 luminaire à grille; aluminium, blanc / plastique, blanc

L 450, B 450, H 11



33108 SALOBRENA-RGBW

grid light; aluminium, white / plastic, white
 Rasterleuchte; Alu, weiss / Kunststoff, weiss
 luminaire à grille; aluminium, blanc / plastique, blanc

L 600, B 300, H 11



SALOBRENA-RGBW

With the remote control (included in delivery) the following features can be adjusted:

Durch die Fernbedienung (im Lieferumfang enthalten) verfügen diese Leuchten über folgende Funktionen:

Les fonctions différentes peuvent être réglées avec une télécommande incluse avec le luminaire:

- > Color change
- > Change to white light
- > Change to RGB
- > Flash (fast color change)
- > Smooth dimming (slow color change)
10%, 25%, 50%, 100%
- > on/off



9 002759 331078

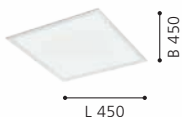

9 002759 331085





33107

LED



GRID LIGHTS SALOBRENA 1

Slim design with 6 mounting options,
Uniform distribution of light - ideal for
illuminating spaces and surfaces

Schlanke Bauform mit 6 Montagevarianten,
Homogene Lichtverteilung – ideal zur
Beleuchtung von Räumen und Flächen

Conception mince avec 6 options de montage,
Distribution uniforme de la lumière - idéal pour
l'illumination des espaces et surfaces



96152



96153



96154



96152 SALOBRENA 1

grid light; aluminium, white / plastic, white
Rasterleuchte; Alu, weiss / Kunststoff, weiss
luminaire à grille; aluminium, blanc / plastique, blanc

L 300, B 300, H 11



14W 2000lm

96153 SALOBRENA 1

grid light; aluminium, white / plastic, white
Rasterleuchte; Alu, weiss / Kunststoff, weiss
luminaire à grille; aluminium, blanc / plastique, blanc

L 595, B 595, H 11



33W 4700lm

96154 SALOBRENA 1

grid light; aluminium, white / plastic, white
Rasterleuchte; Alu, weiss / Kunststoff, weiss
luminaire à grille; aluminium, blanc / plastique, blanc

L 620, B 620, H 11



35W 4400lm



9 002759 961527

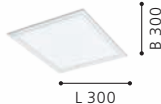

9 002759 961534

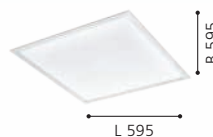

9 002759 961541

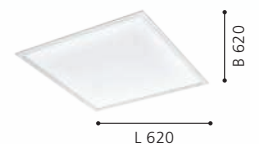



96151

LED

MOUNTING WITH INCLUDED MATERIAL

MONTAGE MIT INKLUDIERTEM MONTAGEMATERIAL

MONTAGE AVEC MATÉRIEL DE MONTAGE INCLUS

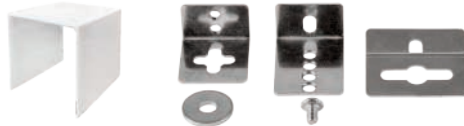

1 GRID LUMINAIRE
RASTERLEUCHTE
LUMINAIRE À GRILLE

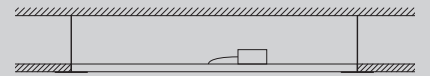

2 RECESSED LUMINAIRE
EINBAULEUCHTE
LUMINAIRE ENCASTRÉE



3 SEMI-RECESSED LUMINAIRE
SEMI-EINBAULEUCHTE
LUMINAIRE SEMI-ENCASTRÉE



4 SURFACE LUMINAIRE
AUFBAULEUCHTE
LUMINAIRE EN SAILLIE

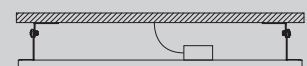

96151 SALOBRENA 1

grid light; aluminium, white / plastic, white
Rasterleuchte; Alu, weiss / Kunststoff, weiss
luminaire à grille; aluminium, blanc / plastique, blanc

L 1200, B 300, H 11

LED

33W

neutral
WHITE

4700lm





61489



61355

61355, 61489

Compatible with: / Kompatibel mit: / Compatible avec :
96151, 96152, 96153, 96154

61358

Compatible with: / Kompatibel mit: / Compatible avec :
96153

61359

Compatible with: / Kompatibel mit: / Compatible avec :
96154

61361

Compatible with: / Kompatibel mit: / Compatible avec :
96151

61489 SALOBRENA 1

accessory; steel, white
Zubehör; Stahl, weiss
accessoire; acier, blanc

L 95, B 95, H 2000

61355 SALOBRENA 1

accessory; steel, chrome
Zubehör; Stahl, chrom
accessoire; acier, chrome

L 900

61358 SALOBRENA 1

accessory; steel, white
Zubehör; Stahl, weiss
accessoire; acier, blanc

L 603, B 603, H 50



9 002759 614898



9 002759 613556

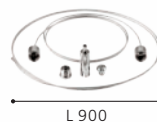

9 002759 613587

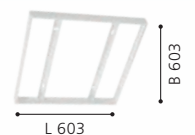

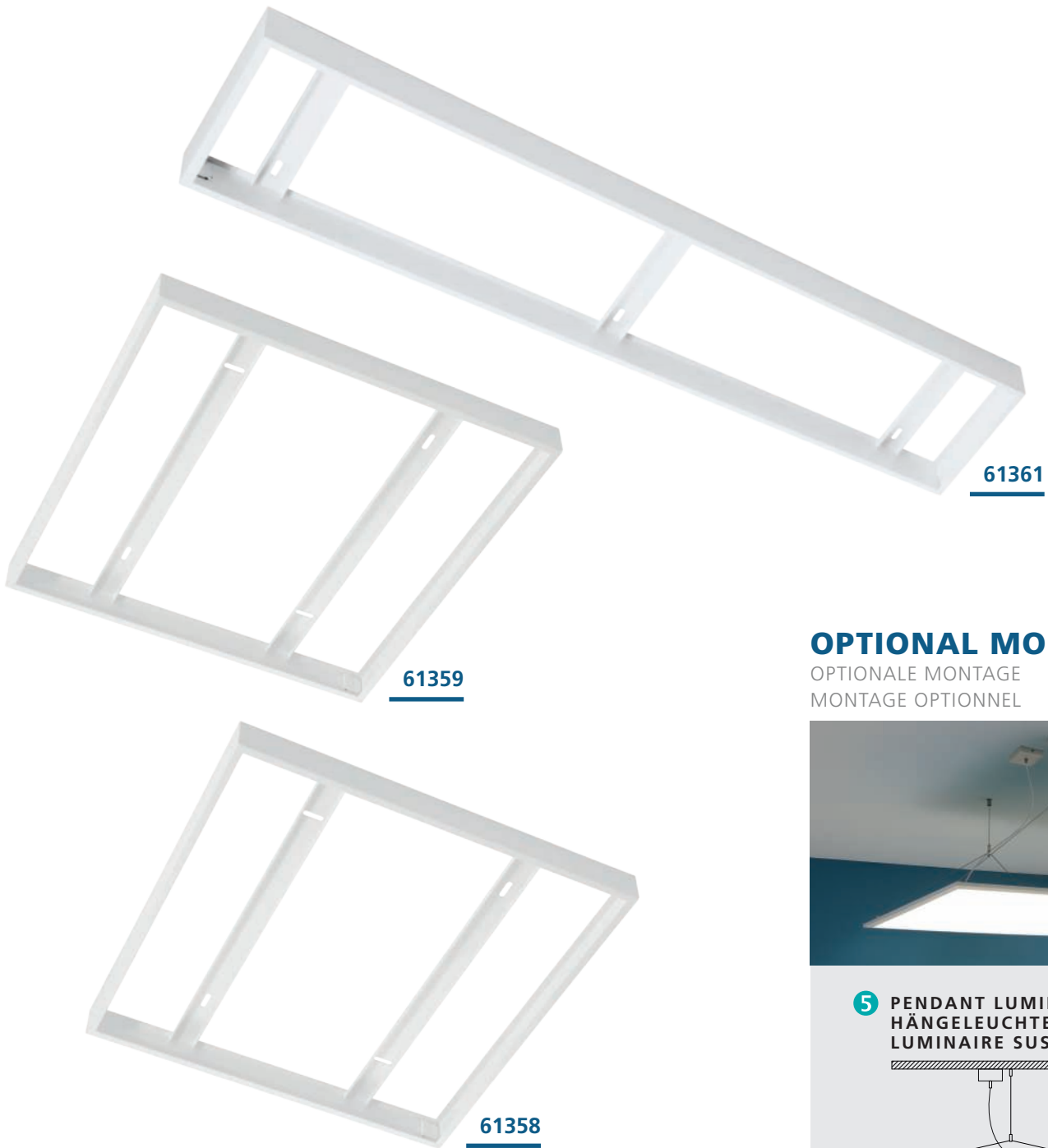

OPTIONAL MOUNTING

OPTIONALE MONTAGE
MONTAGE OPTIONNEL



5 PENDANT LUMINAIRE HÄNGELEUCHTE LUMINAIRE SUSPENSION

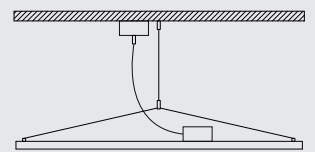

6 FRAME SURFACE LUMINAIRE RAHMEN AUFBAULEUCHTE LUMINAIRE EN SAILLIE AVEC BOX

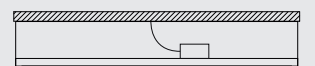

61359 SALOBRENA 1

accessory; steel, white
Zubehör; Stahl, weiss
accessoire; acier, blanc

L 627, B 628, H 50



9 002759 613594

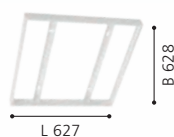

61361 SALOBRENA 1

accessory; steel, white
Zubehör; Stahl, weiss
accessoire; acier, blanc

L 303, B 1205, H 50



9 002759 613617

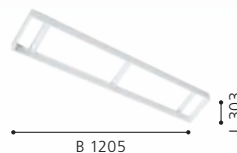



LED PANEL LUMINAIRES

FRAMELESS

ADVANTAGES

- > THE ENTIRE BODY OF THE PANEL IS UTILIZED AS LIGHT SOURCE
 - > ULTRA-FLAT DESIGN
 - > HOMOGENEOUS SURFACE LIGHTING
 - > SIMPLE AND FAST INSTALLATION
 - > ELEGANT SUSPENSION FRAME INCLUDED
 - > DECORATIVE DOMESTIC LIGHTING
 - > WALL AND CEILING LIGHTING
-

VORTEILE

- > DER GESAMTE LEUCHTKÖRPER DIENT ALS LEUCHTFLÄCHE
 - > ULTRAFLACHES DESIGN
 - > HOMOGENE LICHTVERTEILUNG
 - > EINFACHE UND SCHNELLE MONTAGE
 - > INKL. ELEGANTEM SCHWEBERAHMEN
 - > DEKORATIVE WOHNBELEUCHTUNG
 - > WAND- UND DECKENBELEUCHTUNG
-

AVANTAGES

- > LE CORPS ENTIER DU PANNEAU EST UTILISÉ COMME SOURCE DE LUMIÈRE
- > DESIGN ULTRA PLAT
- > ÉCLAIRAGE DE SURFACE HOMOGENÈNE
- > MONTAGE SIMPLE ET RAPIDE
- > BÂTI FLOTTANT ÉLÉGANT INCLUS
- > ÉCLAIRAGE DOMESTIQUE DÉCORATIF
- > ÉCLAIRAGE MURAL ET PLAFONNIER

OVERVIEW



ACCESSORIES INCLUDED

All luminaires including Suspension frame
Alle Leuchten inklusive Schweberahmen
Tous les luminaires inclus bâti flottant



This product is available in different colors and shapes./ Dieser Artikel ist in unterschiedlichen Farben und Formen verfügbar.
Cet article est disponible en différentes couleurs et formes.



900703



TURCONA-B

These luminaires have a backlight technology.

Diese Leuchten verfügen über eine Backlight Technology.

Ces luminaires sont équipés d'une technologie de retour.



900703



900704



900703 TURCONA-B

ceiling light; aluminium, steel, white / plastic, white
Deckenleuchte; Alu, Stahl, weiss / Kunststoff, weiss
plafonnier; aluminium, acier, blanc / plastique, blanc

L 287, B 287, H 62



10,8W



1300lm



900704 TURCONA-B

ceiling light; aluminium, steel, white / plastic, white
Deckenleuchte; Alu, Stahl, weiss / Kunststoff, weiss
plafonnier; aluminium, acier, blanc / plastique, blanc

L 437, B 437, H 70



21W



2800lm



9 008606 259199

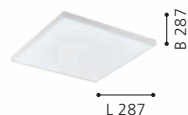

9 008606 259205

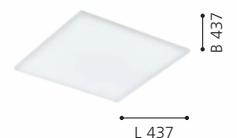



900705



900706



900707



900705 TURCONA-B

ceiling light; aluminium, steel, white / plastic, white
Deckenleuchte; Alu, Stahl, weiss / Kunststoff, weiss
plafonnier; aluminium, acier, blanc / plastique, blanc

L 587, B 587, H 70



32W



4350lm



900706 TURCONA-B

ceiling light; aluminium, steel, white / plastic, white
Deckenleuchte; Alu, Stahl, weiss / Kunststoff, weiss
plafonnier; aluminium, acier, blanc / plastique, blanc

L 1187, B 287, H 70



32W



4350lm



900707 TURCONA-B

ceiling light; aluminium, steel, white / plastic, white
Deckenleuchte; Alu, Stahl, weiss / Kunststoff, weiss
plafonnier; aluminium, acier, blanc / plastique, blanc

L 1200, B 100, H 70



12W



1000lm



9 008606 259212



L 587

B 587



9 008606 259229



L 1187

B 287



9 008606 261994



L 1200

B 100



99843



99844



99845



99843 TURCONA-B

ceiling light; aluminium, steel, white / plastic, white
Deckenleuchte; Alu, Stahl, weiss / Kunststoff, weiss
plafonnier; aluminium, acier, blanc / plastique, blanc

L 287, B 287, H 62



10,8W 1300lm

99844 TURCONA-B

ceiling light; aluminium, steel, white / plastic, white
Deckenleuchte; Alu, Stahl, weiss / Kunststoff, weiss
plafonnier; aluminium, acier, blanc / plastique, blanc

L 437, B 437, H 70



21W 2700lm

99845 TURCONA-B

ceiling light; aluminium, steel, white / plastic, white
Deckenleuchte; Alu, Stahl, weiss / Kunststoff, weiss
plafonnier; aluminium, acier, blanc / plastique, blanc

L 587, B 587, H 70



31,5W 4350lm



9 002759 998431

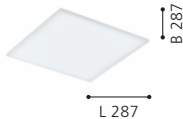

9 002759 998448

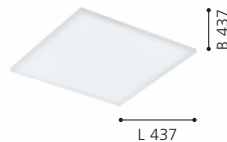

9 002759 998455



TURCONA-B

These luminaires have a backlight technology.

Diese Leuchten verfügen über eine Backlight Technology.

Ces luminaires sont équipés d'une technologie de retour.



99846



900708



99846 TURCONA-B

ceiling light; aluminium, steel, white / plastic, white
Deckenleuchte; Alu, Stahl, weiss / Kunststoff, weiss
plafonnier; aluminium, acier, blanc / plastique, blanc

L 1187, B 287, H 70



31,5W



4350lm



9 002759 998462



900708 TURCONA-B

ceiling light; aluminium, steel, white / plastic, white
Deckenleuchte; Alu, Stahl, weiss / Kunststoff, weiss
plafonnier; aluminium, acier, blanc / plastique, blanc

L 1200, B 100, H 70



12W



1000lm



9 008606 262007

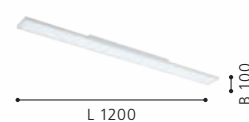

TURCONA - CCT

These luminaires have a backlight technology.

Diese Leuchten verfügen über eine Backlight Technology.

Ces luminaires sont équipés d'une technologie de retour.



99833



incl./inkl./inclus



99833



incl./inkl./inclus



99833 TURCONA-CCT

ceiling light; aluminium, steel, white / plastic, white
Deckenleuchte; Alu, Stahl, weiss / Kunststoff, weiss
plafonnier; aluminium, acier, blanc / plastique, blanc

L 287, B 287, H 62



10,8W



1200lm



remote

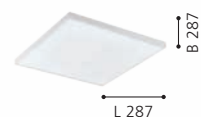



99834



99835



99836



99834 TURCONA-CCT

ceiling light; aluminium, steel, white / plastic, white
Deckenleuchte; Alu, Stahl, weiss / Kunststoff, weiss
plafonnier; aluminium, acier, blanc / plastique, blanc

L 437, B 437, H 70



21,6W



2600lm



remote



99835 TURCONA-CCT

ceiling light; aluminium, steel, white / plastic, white
Deckenleuchte; Alu, Stahl, weiss / Kunststoff, weiss
plafonnier; aluminium, acier, blanc / plastique, blanc

L 587, B 587, H 70



32,4W



4000lm



remote



99836 TURCONA-CCT

ceiling light; aluminium, steel, white / plastic, white
Deckenleuchte; Alu, Stahl, weiss / Kunststoff, weiss
plafonnier; aluminium, acier, blanc / plastique, blanc

L 1187, B 287, H 70



32,4W



3800lm



remote



9 002759 998349

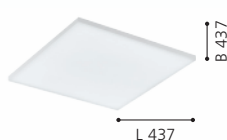

9 002759 998356

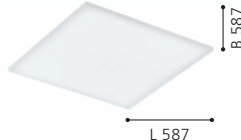

9 002759 998363

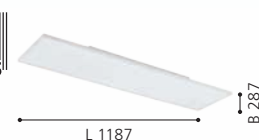



TRUPIANA

These luminaires feature backlight technology and RGBTW function on the entire surface.

Diese Leuchten verfügen über die Backlight Technologie und RGBTW Funktion auf der kompletten Fläche.

Ces luminaires disposent de la technologie de rétroéclairage et la fonction RGBTW sur toute la surface.



900568



incl./inkl./inclus



900569



incl./inkl./inclus



900568 TRUPIANA

ceiling light; aluminium, steel, white / plastic, white
Deckenleuchte; Alu, Stahl, weiss / Kunststoff, weiss
plafonnier; aluminium, acier, blanc / plastique, blanc

L 437, B 437, H 62



21,5W



2600lm



remote

900569 TRUPIANA

ceiling light; aluminium, steel, white / plastic, white
Deckenleuchte; Alu, Stahl, weiss / Kunststoff, weiss
plafonnier; aluminium, acier, blanc / plastique, blanc

L 587, B 587, H 62



33,5W



4200lm



remote



9 008606 244706

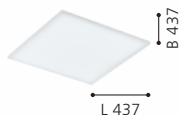

9 008606 244713

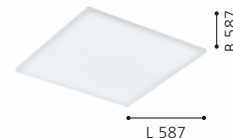

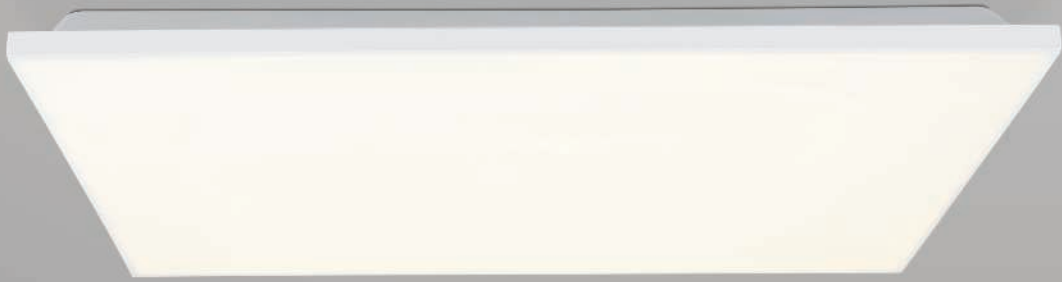

900568

LED





98901



98902



98903



TURCONA

These luminaires have an edgelight technology.

Diese Leuchten verfügen über eine Edgelight Technology.

Ces luminaires sont équipés d'une technologie edgelight.

98901 TURCONA

ceiling light; steel, white / plastic, satined
Deckenleuchte; Stahl, weiss / Kunststoff, satiniert
plafonnier; acier, blanc / plastique, satiné

L 300, B 300, H 60



11W 1500lm

98902 TURCONA

ceiling light; steel, white / plastic, satined
Deckenleuchte; Stahl, weiss / Kunststoff, satiniert
plafonnier; acier, blanc / plastique, satiné

L 450, B 450, H 60



20W 2900lm

98903 TURCONA

ceiling light; steel, white / plastic, satined
Deckenleuchte; Stahl, weiss / Kunststoff, satiniert
plafonnier; acier, blanc / plastique, satiné

L 595, B 595, H 60



33W 4600lm



9 002759 989019

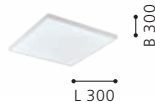

9 002759 989026

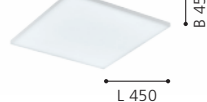

9 002759 989033

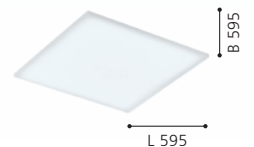



98904



98905



98904 TURCONA

ceiling light; steel, white / plastic, satined
 Deckenleuchte; Stahl, weiss / Kunststoff, satiniert
 plafonnier; acier, blanc / plastique, satiné

L 1200, B 300, H 60



33W 4600lm

98905 TURCONA

ceiling light; steel, white / plastic, satined
 Deckenleuchte; Stahl, weiss / Kunststoff, satiniert
 plafonnier; acier, blanc / plastique, satiné

L 1200, B 100, H 60



19W 3050lm

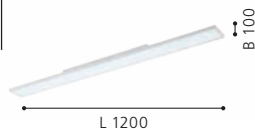
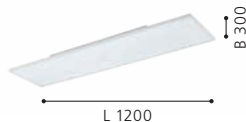

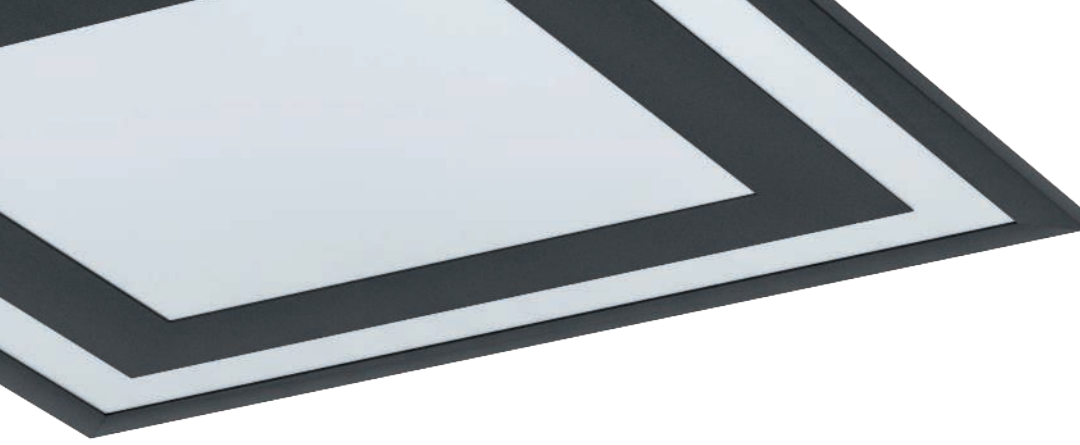

LED PANEL LUMINAIRES

DECORATIVE

ADVANTAGES

- > ULTRA-FLAT DESIGN
 - > HOMOGENEOUS SURFACE LIGHTING
 - > SIMPLE AND FAST INSTALLATION
 - > DECORATIVE DOMESTIC LIGHTING
 - > WALL AND CEILING LIGHTING
-

VORTEILE

- > ULTRAFLACHES DESIGN
 - > HOMOGENE LICHTVERTEILUNG
 - > EINFACHE UND SCHNELLE MONTAGE
 - > DEKORATIVE WOHNBELEUCHTUNG
 - > WAND- UND DECKENBELEUCHTUNG
-

AVANTAGES

- > DESIGN ULTRA PLAT
- > ÉCLAIRAGE DE SURFACE HOMOGENÈ
- > MONTAGE SIMPLE ET RAPIDE
- > ÉCLAIRAGE DOMESTIQUE DÉCORATIF
- > ÉCLAIRAGE MURAL ET PLAFONNIER

OVERVIEW



BORDONARA
p. 128



MARMORATA
p. 130



SAVATARILA
p. 132



LAZARAS
p. 133



This product is available in different colors and shapes./ Dieser Artikel ist in unterschiedlichen Farben und Formen verfügbar.
Cet article est disponible en différentes couleurs et formes.



BORDONARA

These luminaires have a TW function on the entire surface and an additional RGB element.

Diese Leuchten verfügen über eine TW Funktion auf der gesamten Fläche und über ein zusätzliches RGB Element.

Ces luminaires disposent d'une fonction TW sur toute la surface et d'un élément RGB supplémentaire.



900571



incl./inkl./inclus



900572



incl./inkl./inclus



900573



incl./inkl./inclus



900571 BORDONARA

ceiling light; aluminium, steel, black, white / plastic, white
Deckenleuchte; Alu, Stahl, schwarz, weiss / Kunststoff, weiss
plafonnier; aluminium, acier, noir, blanc / plastique, blanc

L 450, B 450



21,5W 2800lm

remote

900572 BORDONARA

ceiling light; aluminium, steel, black, white / plastic, white
Deckenleuchte; Alu, Stahl, schwarz, weiss / Kunststoff, weiss
plafonnier; aluminium, acier, noir, blanc / plastique, blanc

L 595, B 595



36W 4900lm

remote

900573 BORDONARA

ceiling light; aluminium, steel, black, white / plastic, white
Deckenleuchte; Alu, Stahl, schwarz, weiss / Kunststoff, weiss
plafonnier; aluminium, acier, noir, blanc / plastique, blanc

L 1195, B 295



35W 5400lm

remote



9 008606 244720

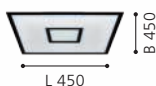

9 008606 244737



9 008606 244744





900571

LED





MARMORATA

Modus 1
Only the outer are glows / Nur die äußere Fläche leuchtet/ Seule la surface extérieure brille

Modus 2
A "starry sky effect" is created in the central area/ Ein "Sternenhimmelleffekt" entsteht in den zentralen Fläche/ Un "effet de ciel étoilé" est créé dans la zone centrale

Modus 3
The outer area glows and a "starry sky effect" is created in the central area/ Die äußere Fläche leuchtet und ein "Sternenhimmelleffekt" entsteht in den zentralen Fläche/ La surface extérieure brille et un "effet de ciel étoilé" est créé dans la surface centrale



900558

LED



900559

LED

900558 MARMORATA

ceiling light; aluminium, steel, black, white / plastic, white
Deckenleuchte; Alu, Stahl, schwarz, weiss / Kunststoff, weiss
plafonnier; aluminium, acier, noir, blanc / plastique, blanc

H 70, Ø 450



18W 2300lm 9W 1100lm



9 008606 244614



900559 MARMORATA

ceiling light; aluminium, steel, black, white / plastic, white
Deckenleuchte; Alu, Stahl, schwarz, weiss / Kunststoff, weiss
plafonnier; aluminium, acier, noir, blanc / plastique, blanc

L 445, B 445

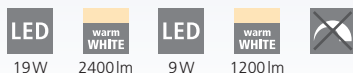

19W 2400lm 9W 1200lm



9 008606 244621



900561 MARMORATA

ceiling light; aluminium, steel, black, white / plastic, white
Deckenleuchte; Alu, Stahl, schwarz, weiss / Kunststoff, weiss
plafonnier; aluminium, acier, noir, blanc / plastique, blanc

L 595, B 295



17W 2400lm 9W 1100lm



9 008606 244638





900561

LED



900558

LED

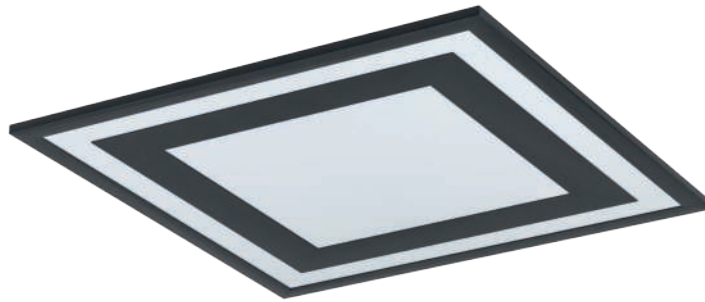

99038



99039



99038 SAVATARILA

ceiling light; aluminium, black / plastic, white
Deckenleuchte; Alu, schwarz / Kunststoff, weiss
plafonnier; aluminium, noir / plastique, blanc

L 450, B 450, H 60



22,2W



2650lm



9 002759 990381

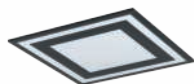

L 450

B 450

99039 SAVATARILA

ceiling light; aluminium, black / plastic, white
Deckenleuchte; Alu, schwarz / Kunststoff, weiss
plafonnier; aluminium, noir / plastique, blanc

L 595, B 595, H 60



32,5W



4000lm



9 002759 990398

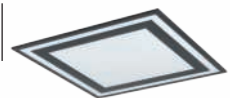

L 595

B 595



99842



incl./inkl./inclus



99841



incl./inkl./inclus

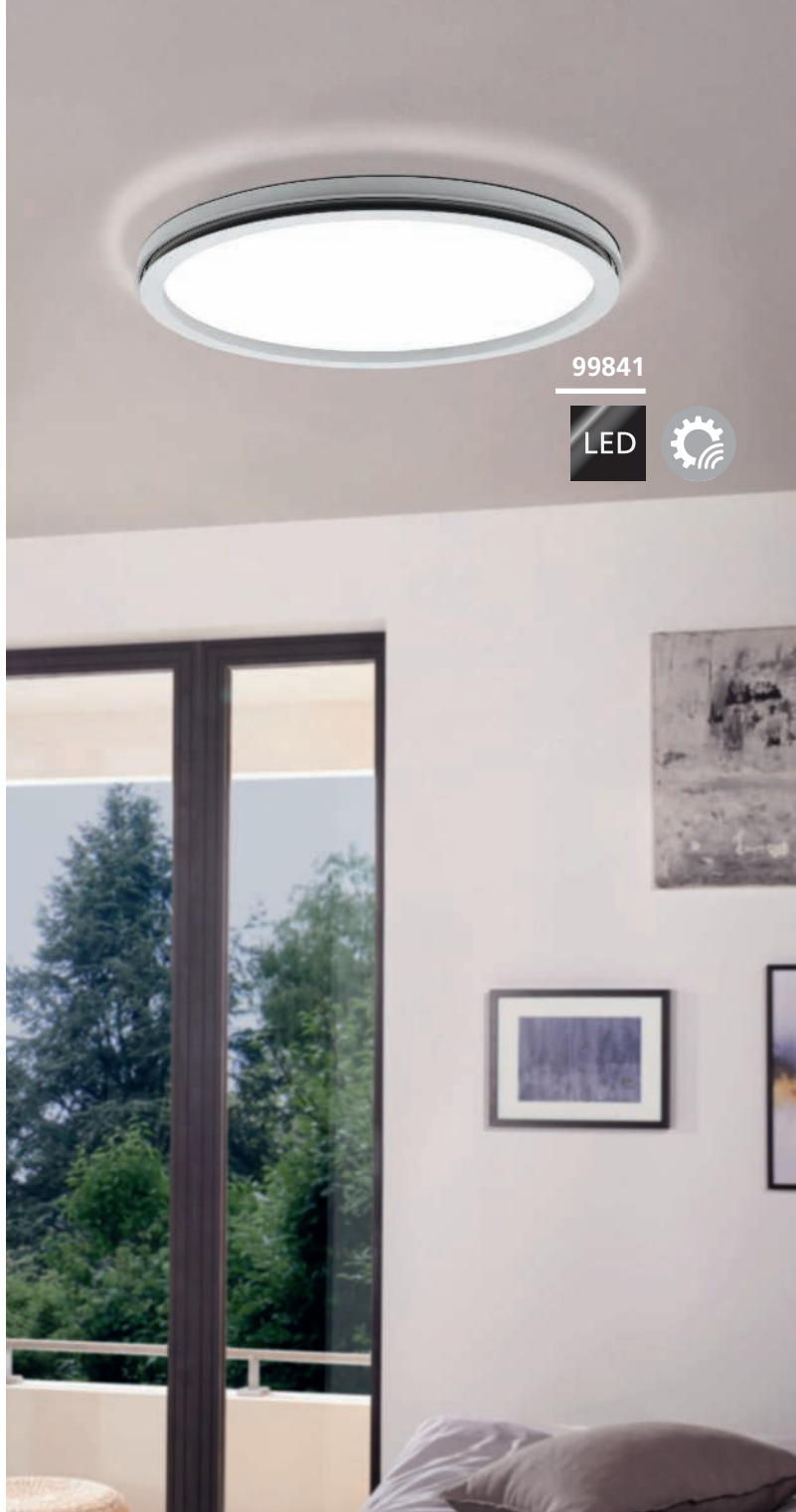

99841



99842 LAZARAS

ceiling light; aluminium, steel, white / plastic, white
Deckenleuchte; Alu, Stahl, weiss / Kunststoff, weiss
plafonnier; aluminium, acier, blanc / plastique, blanc

L 450, B 450, H 60



99841 LAZARAS

ceiling light; aluminium, steel, white / plastic, white
Deckenleuchte; Alu, Stahl, weiss / Kunststoff, weiss
plafonnier; aluminium, acier, blanc / plastique, blanc

H 55, Ø 450



9 002759 998424



9 002759 998417





LED PANEL LUMINAIRES

WOOD FRAME

ADVANTAGES

- > DECORATIVE ELEMENT FOR THE LIVING AREA
 - > EASY ASSEMBLY
 - > EASY TO CHANGE
 - > IN 3 WOOD COLORS
 - > WOOD AS A RENEWABLE RAW MATERIAL
-

VORTEILE

- > DEKORATIVES ELEMENT FÜR DEN WOHNBEREICH
 - > EINFACHE MONTAGE
 - > EINFACH WECHSELBAR
 - > IN 3 HOLZFARBEN
 - > HOLZ ALS NACHWACHSENDER ROHSTOFF
-

AVANTAGES

- > ÉLÉMENT DÉCORATIF POUR LE SALON
- > MONTAGE FACILE
- > FACILE À CHANGER
- > EN 3 COULEURS DE BOIS
- > LE BOIS COMME MATIÈRE PREMIÈRE RENOUVELABLE

OVERVIEW



PIGLIONASSO
p. 136 - 138



SALOBRENA-F
p. 140 - 145



This product is available in different colors and shapes./ Dieser Artikel ist in unterschiedlichen Farben und Formen verfügbar.
Cet article est disponible en différentes couleurs et formes.



99435



99436



99437



99435 PIGLIONASSO

ceiling light; steel, plastic, white / wood, rustikal
Deckenleuchte; Stahl, Kunststoff, weiss / Holz, rustikal
plafonnier; acier, plastique, blanc / bois, rustique

L 500, B 500, H 55



20W 2850lm



9 002759 994358

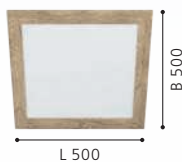

99436 PIGLIONASSO

ceiling light; steel, plastic, white / wood, rustikal
Deckenleuchte; Stahl, Kunststoff, weiss / Holz, rustikal
plafonnier; acier, plastique, blanc / bois, rustique

L 645, B 645, H 55



32W 4700lm



9 002759 994365



99437 PIGLIONASSO

ceiling light; steel, plastic, white / wood, rustikal
Deckenleuchte; Stahl, Kunststoff, weiss / Holz, rustikal
plafonnier; acier, plastique, blanc / bois, rustique

L 1245, B 345, H 55



32W 4700lm



9 002759 994372





99471



99472



99473



99471 PIGLIONASSO

ceiling light; steel, plastic, white / wood, brown
Deckenleuchte; Stahl, Kunststoff, weiss / Holz, braun
plafonnier; acier, plastique, blanc / bois, marron

L 500, B 500, H 55



20W 2850lm

99472 PIGLIONASSO

ceiling light; steel, plastic, white / wood, brown
Deckenleuchte; Stahl, Kunststoff, weiss / Holz, braun
plafonnier; acier, plastique, blanc / bois, marron

L 645, B 645, H 55



32W 4700lm

99473 PIGLIONASSO

ceiling light; steel, plastic, white / wood, brown
Deckenleuchte; Stahl, Kunststoff, weiss / Holz, braun
plafonnier; acier, plastique, blanc / bois, marron

L 1245, B 345, H 55



32W 4700lm



9 002759 994716

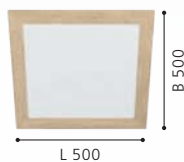

9 002759 994723



9 002759 994730





99474

LED



99475

LED



99476

LED

99474 PIGLIONASSO

ceiling light; steel, plastic, white / wood, dark brown
Deckenleuchte; Stahl, Kunststoff, weiss / Holz, dunkelbraun
plafonnier; acier, plastique, blanc / bois, marron foncé

L 500, B 500, H 55



20W 2850lm



9 002759 994747



99475 PIGLIONASSO

ceiling light; steel, plastic, white / wood, dark brown
Deckenleuchte; Stahl, Kunststoff, weiss / Holz, dunkelbraun
plafonnier; acier, plastique, blanc / bois, marron foncé

L 645, B 645, H 55



32W 4700lm



9 002759 994754



99476 PIGLIONASSO

ceiling light; steel, plastic, white / wood, dark brown
Deckenleuchte; Stahl, Kunststoff, weiss / Holz, dunkelbraun
plafonnier; acier, plastique, blanc / bois, marron foncé

L 1245, B 345, H 55



32W 4700lm



9 002759 994761





99475

LED



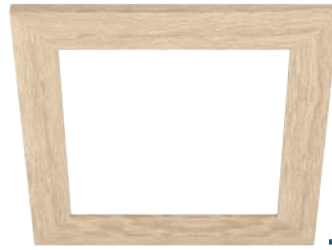

99421



99422

99421 SALOBRENA-F

accessory; wood, brown
Zubehör; Holz, braun
accessoire; bois, marron

L 340, B 340, H 16



9 002759 994211

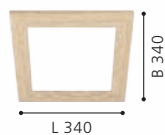

L 340

B 340



9 002759 994228

99422 SALOBRENA-F

accessory; wood, brown
Zubehör; Holz, braun
accessoire; bois, marron

L 495, B 495, H 18

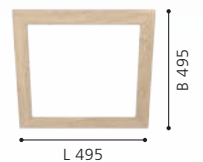

L 495

B 495



99423

SALOBRENA-F

Articles compatible with SALOBRENA Panels.

Diese Artikel sind kompatibel mit SALOBRENA Flächenleuchten.

Articles compatibles avec les panneaux SALOBRENA.

300 x 300: 32812
450 x 450: 98129
595 x 595: 32813
1200 x 300: 32811
1195 x 100: 98025

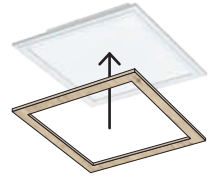

99424

99423 SALOBRENA-F

accessory; wood, brown
Zubehör; Holz, braun
accessoire; bois, marron

L 640, B 640, H 18

99424 SALOBRENA-F

accessory; wood, brown
Zubehör; Holz, braun
accessoire; bois, marron

L 1240, B 340, H 18



9 002759 994235

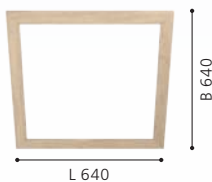

9 002759 994242

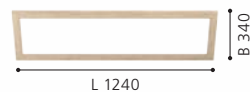



99425



99426

99425 SALOBRENA-F

accessory; wood, dark brown
Zubehör; Holz, dunkelbraun
accessoire; bois, marron foncé

L 340, B 340, H 16



9 002759 994259



L 340

B 340

99426 SALOBRENA-F

accessory; wood, dark brown
Zubehör; Holz, dunkelbraun
accessoire; bois, marron foncé

L 495, B 495, H 18



9 002759 994266



L 495

B 495

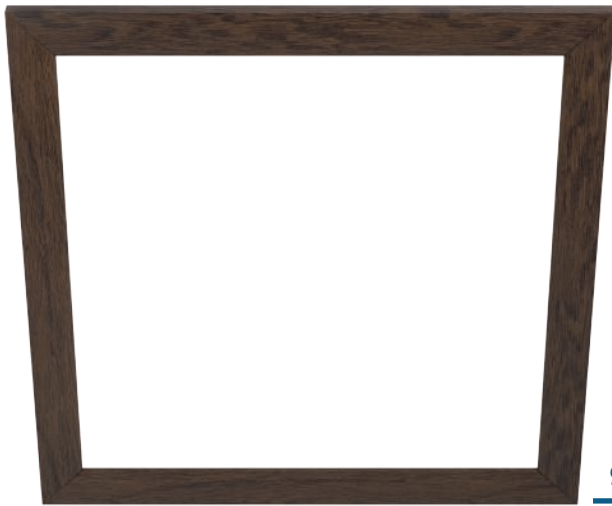

99427

SALOBRENA-F

Articles compatibles with SALOBRENA Panels.

Diese Artikel sind kompatibel mit SALOBRENA Flächenleuchten.

Articles compatibles avec les panneaux SALOBRENA.

300 x 300: 32812
450 x 450: 98129
595 x 595: 32813
1200 x 300: 32811
1195 x 100: 98025



99428

99427 SALOBRENA-F

accessory; wood, dark brown
Zubehör; Holz, dunkelbraun
accessoire; bois, marron foncé

L 640, B 640, H 18

99428 SALOBRENA-F

accessory; wood, dark brown
Zubehör; Holz, dunkelbraun
accessoire; bois, marron foncé

L 1240, B 340, H 18



9 002759 994273

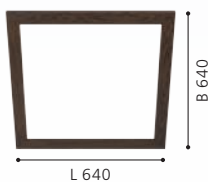

9 002759 994280





99431



99432

99431 SALOBRENA-F

accessory; wood, rustic
Zubehör; Holz, rustikal
accessoire; bois, rustique

L 340, B 340, H 16



9 002759 994310



L 340

99432 SALOBRENA-F

accessory; wood, rustic
Zubehör; Holz, rustikal
accessoire; bois, rustique

L 495, B 495, H 18



9 002759 994327



L 495



99433

SALOBRENA-F

Articles compatibles with SALOBRENA Panels.

Diese Artikel sind kompatibel mit SALOBRENA Flächenleuchten.

Articles compatibles avec les panneaux SALOBRENA.

300 x 300: 32812
450 x 450: 98129
595 x 595: 32813
1200 x 300: 32811
1195 x 100: 98025

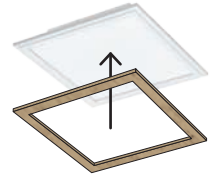

99434

99433 SALOBRENA-F

accessory; wood, rustic
Zubehör; Holz, rustikal
accessoire; bois, rustique

L 640, B 640, H 18

99434 SALOBRENA-F

accessory; wood, rustic
Zubehör; Holz, rustikal
accessoire; bois, rustique

L 1240, B 340, H 18



9 002759 994334

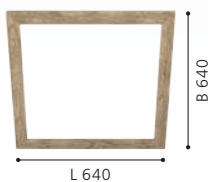

9 002759 994341

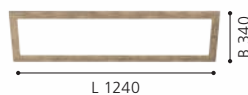



DOWNLIGHTS

ADVANTAGES

EMPHASIZE THE FEATURES - DISCREET IN THE APPEARANCE, PERFECTION IN STAGING. INSTEAD OF PUTTING THEMSELVES IN SCENE, THE RECESSED & SURFACE MOUNTED LUMINAIRES ARE HIGHLIGHTING YOUR LIVING AREA. THEY CONVINCED WITH THEIR UNCOMPLICATED APPLICATION AND DUE TO THE USE OF LED-PLATES AND LED-ILLUMINANTS THEY ARE POWER- AND COST-SAVING.

VORTEILE

DEZENT IM AUFTRETEN, PERFEKT IN DER INSZENIERUNG. UNSERE EIN- UND AUFBAULEUCHTEN SETZEN NICHT SICH SELBST, SONDERN IHR ZUHAUSE IN SZENE. SIE ÜBERZEUGEN MIT IHRER UNKOMPLIZIERTEN ANWENDUNG UND SIND AUFGRUND DER LED-PLATINEN UND LED-LEUCHTMITTEL STROM- UND KOSTENSPAREND.

AVANTAGES

DISCRET EN APPARENCE - PARFAIT DANS LA MIS EN SCÈNE. NOS LUMINAIRES ENCASTRÉES ET EN SAILLIE NE METTENT PAS EUX-MÊMES EN SCÈNE, MAIS VOTRE MAISON. ILS IMPRESSIONNENT PAR LEUR APPLICATION SIMPLE. EN PLUS, ILS RÉDUISENT LES COÛTS ET LE BESOIN D'ÉNERGIE GRÂCE AUX PLATINES ET LAMPES À LED.







RECESSED DOWNLIGHTS

HIGH VOLTAGE

ADVANTAGES

- > LOW MOUNTING DEPTH
- > NO TRANSFORMER NECESSARY - THE LATEST LED HIGH-VOLTAGE TECHNOLOGY
- > IDEAL FOR LIGHTING OF ROOMS AND AREAS
- > PLEASANT WARM WHITE LIGHT COLOR
- > LOW TEMPERATURE ENHANCES SAFETY
- > UP TO 80% POWER SAVINGS COMPARED TO INCANDESCENT LAMPS, EASY ON YOUR BUDGET AND THE ENVIRONMENT
- > EASY AND SIMPLE WIRING BY 2-FOLD JUNCTION BOX - EASILY EXPANDABLE

VORTEILE

- > GERINGE EINBAUTIEFE
- > KEIN TRAFO MEHR NOTWENDIG – NEUESTE LED HOCHVOLT TECHNOLOGIE
- > IDEAL ZUR BELEUCHTUNG VON RÄUMEN UND FLÄCHEN
- > ANGENEHME WARM-WEISSE LICHTFARBE
- > GERINGE WÄRMEENTWICKLUNG SORGT FÜR MEHR SICHERHEIT
- > BIS ZU 80% STROMERSPARNIS GEGENÜBER GLÜHLAMPEN. SCHONT IHR BUDGET UND DIE UMWELT
- > EINFACHE UND SICHERE VERKABELUNG DURCH 2-FACH ANSCHLUSSBOX – UNKOMPLIZIERT ERWEITERBAR

AVANTAGES

- > FAIBLE PROFONDEUR DE MONTAGE
- > AUCUN TRANSFORMATEUR NÉCESSAIRE - LA DERNIÈRE TECHNOLOGIE À HAUTE TENSION LED
- > IDÉAL POUR L'ÉCLAIRAGE DES CHAMBRES ET DES ESPACES
- > AGRÉABLE COULEUR DE LUMIÈRE BLANCHE CHAUDE
- > FAIBLE CHALEUR AMÉLIORE LA SÉCURITÉ
- > JUSQU'À 80% D'ÉCONOMIES D'ÉNERGIE PAR RAPPORT AUX LAMPES À INCANDESCENCE. RÉDUIT VOTRE BUDGET ET PROTÈGE L'ENVIRONNEMENT
- > NOTRE BOÎTE DE DEUX JONCTIONS PERMET UN CÂBLAGE SIMPLE ET SÛRE. EN PLUS ELLE EST FACILEMENT EXTENSIBLE.

OVERVIEW



PINEDA
p. 152 - 164



PINEDA 1
p. 165



SARTIANO
p. 166



SALICETO
p. 169 - 175



SALABATE
p. 176 - 177



ZARATE
p. 178



MECINOS
p. 179



This product is available in different colors and shapes./ Dieser Artikel ist in unterschiedlichen Farben und Formen verfügbar.
Cet article est disponible en différentes couleurs et formes.



1

SIMPLE INSTALLATION!

Einfache Montage! / Montage simple !

Universally usable in walls or ceilings thanks to its small installation depth!

Durch die geringe Einbautiefe universell einsetzbar, ob Wand oder Decke!

Emploi universel dû à la faible profondeur de montage, que ce soit au mur ou au plafond !

2

QUICK AND SAFE CONNECTION!

Schnelles und sicheres Anschließen! / Branchement rapide et sûr !

Easy wiring with the practical connection box! No transformer is needed anymore thanks to state of-the-art high-voltage technology!

Leichtes Verkabeln durch die praktische Anschlussbox! Durch moderne Hochvolt-Technik wird kein Trafo mehr benötigt!

Câbler simplement avec le boîtier de branchement pratique ! Grâce à la technique de haute tension moderne, plus besoin de transformateur !



3

PERFECT FIT!

Perfekter Halt! / Maintien parfait !

The integrated holding brackets permit simple installation and guarantee for a precise fit!

Die integrierten Halteklammern ermöglichen einen einfachen Einbau und sorgen für garantierte Passgenauigkeit!

Les griffes de maintien intégrées permettent un montage simple et assurent un parfait ajustement !





4

FLUSH INSTALLATION!

FLÄCHENBÜNDIGER EINBAU! / MONTAGE À FLEUR !

The slim build permits fitting installation in any surface!

Die schlanke Bauform ermöglicht den passenden Einbau bei jeder Fläche!

La structure fine permet le montage adéquat avec chaque surface !





95848

LED



95848

LED

95848 PINEDA

recessed light; plastic, chrome
 Einbauleuchte; Kunststoff, chrom
 luminaire encastrable; plastique, chrome

Ø 84, ET 40

LED

1x 4,9W

warm
 WHITE

460lm



Ø 72



9 002759 958480



RECESSED





95856



95855



95855 PINEDA

recessed light; plastic, chrome
Einbauleuchte; Kunststoff, chrom
luminaire encastrable; plastique, chrome

Ø 84, ET 40



1x 5,5W

500lm

Ø 72



9 002759 958558



Ø 84

95856 PINEDA

recessed light; plastic, satin nickel
Einbauleuchte; Kunststoff, nickel-matt
luminaire encastrable; plastique, nickel mat

Ø 84, ET 40



1x 5,5W

500lm

Ø 72



9 002759 958565



Ø 84



95851

LED



95853

LED



95852

LED

95851 PINEDA

recessed light; plastic, white
 Einbauleuchte; Kunststoff, weiss
 luminaire encastrable; plastique, blanc

95852 PINEDA

recessed light; plastic, chrome
 Einbauleuchte; Kunststoff, chrom
 luminaire encastrable; plastique, chrome

95853 PINEDA

recessed light; plastic, satin nickel
 Einbauleuchte; Kunststoff, nickel-matt
 luminaire encastrable; plastique, nickel mat

Ø 84, ET 40



3x 4,9W 1470lm



9 002759 958510



Ø 84

Ø 84, ET 40



3x 4,9W 1470lm



9 002759 958527

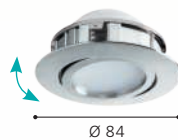

Ø 84

Ø 84, ET 40



3x 4,9W 1470lm



9 002759 958534



Ø 84



95857



95859



95858



95857 PINEDA

recessed light; plastic, white
 Einbauleuchte; Kunststoff, weiss
 luminaire encastrable; plastique, blanc

Ø 84, ET 40



3x 5,5W 1500lm

Ø 72



95858 PINEDA

recessed light; plastic, chrome
 Einbauleuchte; Kunststoff, chrom
 luminaire encastrable; plastique, chrome

Ø 84, ET 40



3x 5,5W 1500lm

Ø 72

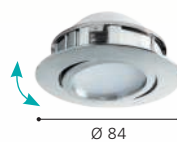

95859 PINEDA

recessed light; plastic, satin nickel
 Einbauleuchte; Kunststoff, nickel-matt
 luminaire encastrable; plastique, nickel mat

Ø 84, ET 40



3x 5,5W 1500lm

Ø 72





900749

LED

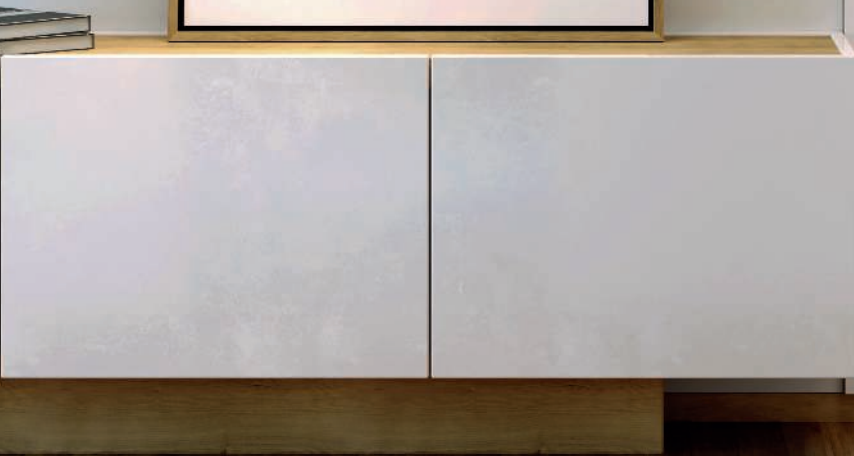



900748



900749



900748 PINEDA

recessed light; plastic, black
Einbauleuchte; Kunststoff, schwarz
luminaire encastrable; plastique, noir

Ø 84, ET 40



1x 5,5W

500lm

Ø 72

900749 PINEDA

recessed light; plastic, black
Einbauleuchte; Kunststoff, schwarz
luminaire encastrable; plastique, noir

Ø 84, ET 40



3x 5,5W

1500lm

Ø 72



9 008606 253753



Ø 84



9 008606 253760



Ø 84



95843

LED



95844

LED



95846

LED



95843 PINEDA

recessed light; plastic, satin nickel
 Einbauleuchte; Kunststoff, nickel-matt
 luminaire encastrable; plastique, nickel mat

95846 PINEDA

recessed light; plastic, satin nickel
 Einbauleuchte; Kunststoff, nickel-matt
 luminaire encastrable; plastique, nickel mat

95844 PINEDA

recessed light; plastic, white
 Einbauleuchte; Kunststoff, weiss
 luminaire encastrable; plastique, blanc

L 84, B 84, ET 40

LED warm WHITE 1x 4,9W 460lm Ø72



L 84, B 84, ET 40

LED warm WHITE 3x 4,9W 1380lm Ø72



L 84, B 84, ET 40

LED warm WHITE 3x 4,9W 1380lm Ø72

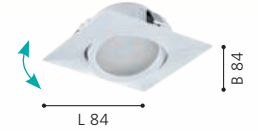



95844

LED



95817



IP20/44



95819



IP20/44



95818



IP20/44

95817 PINEDA

recessed light; plastic, white
Einbauleuchte; Kunststoff, weiss
luminaire encastrable; plastique, blanc

95818 PINEDA

recessed light; plastic, chrome
Einbauleuchte; Kunststoff, chrom
luminaire encastrable; plastique, chrome

95819 PINEDA

recessed light; plastic, satin nickel
Einbauleuchte; Kunststoff, nickel-matt
luminaire encastrable; plastique, nickel mat

Ø 78, ET 35



1x 4,9W 460lm



IP44/20



9 002759 958176



Ø 78

Ø 78, ET 35



1x 4,9W 460lm



IP44/20



9 002759 958183



Ø 78

Ø 78, ET 35



1x 4,9W 460lm



IP44/20



9 002759 958190



Ø 78



900743



IP20/44

900743 PINEDA

recessed light; plastic, black
Einbauleuchte; Kunststoff, schwarz
luminaire encastrable; plastique, noir

Ø 78, ET 35

LED

1x 4,9W

warm
WHITE

460lm



Ø 65



IP44/20



Ø 78



900743



IP20/44



95821



IP20/44



95822



IP20/44

95821 PINEDA

recessed light; plastic, white
 Einbauleuchte; Kunststoff, weiss
 luminaire encastrable; plastique, blanc

Ø 78, ET 35



3x 4,9W



1380lm



Ø65



IP44/20



9 002759 958213



Ø 78

95822 PINEDA

recessed light; plastic, chrome
 Einbauleuchte; Kunststoff, chrom
 luminaire encastrable; plastique, chrome

Ø 78, ET 35



3x 4,9W



1380lm



Ø65



IP44/20



9 002759 958220



Ø 78



95823



IP20/44



900744



IP20/44

95823 PINEDA

recessed light; plastic, satin nickel
 Einbauleuchte; Kunststoff, nickel-matt
 luminaire encastrable; plastique, nickel mat

Ø 78, ET 35



3x 4,9W



1380lm



Ø 65



IP44/20



9 002759 958237



Ø 78



900744 PINEDA

recessed light; plastic, black
 Einbauleuchte; Kunststoff, schwarz
 luminaire encastrable; plastique, noir

Ø 78, ET 35



3x 4,9W



1380lm



Ø 65



IP44/20



9 008606 253715



Ø 78



PINEDA

These luminaires are protected against splash water.

Diese Leuchten sind gegen Spritzwasser geschützt.

Les luminaires sont protégées contre les éclaboussures d'eau.



	0	1	2	3
EU	X	X	✓	✓
FR	X	X	X	✓



95887



IP20/44



95888



IP20/44



95889



IP20/44

95887 PINEDA

recessed light; plastic, white
Einbauleuchte; Kunststoff, weiss
luminaire encastrable; plastique, blanc

Ø 102, ET 35



1x 11W 1100lm



Ø 102

Ø 102, ET 35



1x 12W 1x 1000lm



Ø 102

Ø 102, ET 35



1x 12W 1x 1000lm



Ø 102

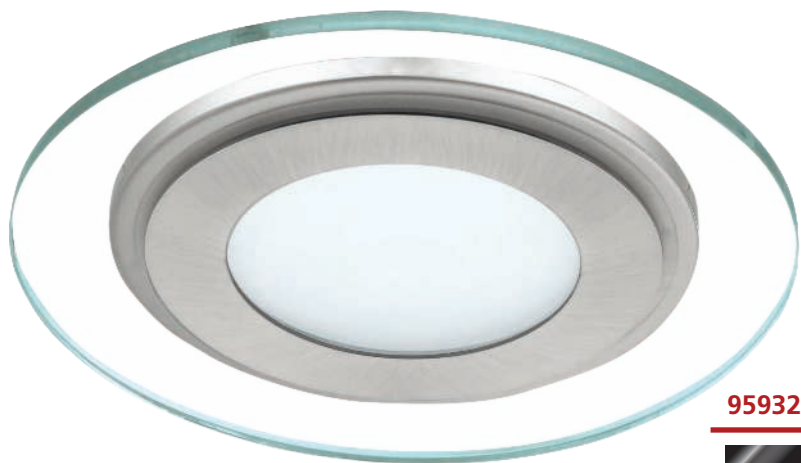

95932

LED



95932

LED

95932 PINEDA 1

recessed light; steel, plastic, white, satin nickel / plastic, clear, satined

Einbauleuchte; Stahl, Kunststoff, weiss, nickel-matt / Kunststoff, klar, satiniert

luminaire encastrable; acier, plastique, blanc, nickel mat / plastique, transparent, satiné
 Ø 145, ET 35

LED

1x 11W

warm
WHITE

860lm



Ø 90



9 002759 959326



Ø 145



RECESSED



32896 SARTIANO

recessed light; plastic, white
 Einbauleuchte; Kunststoff, weiss
 luminaire encastrable; plastique, blanc

Ø 90, ET 45

LED

3x 4,6W

warm
WHITE

3x 500lm



Ø 73

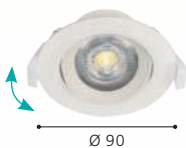



32896

LED



98607





98243

LED



98244

LED



98607

LED



98243 SALICETO

recessed light; aluminium, white
Einbauleuchte; Alu, weiss
luminaire encastrable; aluminium, blanc

H 42, Ø 88, ET 50



98244 SALICETO

recessed light; aluminium, satin nickel
Einbauleuchte; Alu, nickel-matt
luminaire encastrable; aluminium, nickel mat

H 42, Ø 88, ET 50



98607 SALICETO

recessed light; aluminium, black
Einbauleuchte; Alu, schwarz
luminaire encastrable; aluminium, noir

H 42, Ø 88, ET 50





98474



98472



98472 SALICETO

recessed light; aluminium, satin nickel / glass, clear
 Einbauleuchte; Alu, nickel-matt / Glas, klar
 luminaire encastrable; aluminium, nickel mat / verre, transparent

L 88, B 88, H 42, ET 50



6W



380lm



Ø68



98474 SALICETO

recessed light; aluminium, satin nickel / glass, clear
 Einbauleuchte; Alu, nickel-matt / Glas, klar
 luminaire encastrable; aluminium, nickel mat / verre, transparent

L 88, B 88, H 42, ET 50



6W



450lm



Ø68



9 002759 984724



L 88



9 002759 984748



L 88



98474

LED





98301



98303



98609



98301 SALICETO

recessed light; aluminium, white
Einbauleuchte; Alu, weiss
luminaire encastrable; aluminium, blanc

H 42, Ø 88, ET 50



6W 450lm

Ø 68



9 002759 983017



Ø 88

98303 SALICETO

recessed light; aluminium, satin nickel
Einbauleuchte; Alu, nickel-matt
luminaire encastrable; aluminium, nickel mat

H 42, Ø 88, ET 50



6W 450lm

Ø 68



9 002759 983031



Ø 88

98609 SALICETO

recessed light; aluminium, black
Einbauleuchte; Alu, schwarz
luminaire encastrable; aluminium, noir

H 42, Ø 88, ET 50



6W 380lm

Ø 68



9 002759 986094



Ø 88



98305



900747



98307



98305 SALICETO

recessed light; aluminium, white
 Einbauleuchte; Alu, weiss
 luminaire encastrable; aluminium, blanc

H 42, Ø 88, ET 50



98307 SALICETO

recessed light; aluminium, satin nickel
 Einbauleuchte; Alu, nickel-matt
 luminaire encastrable; aluminium, nickel mat

H 42, Ø 88, ET 50



900747 SALICETO

recessed light; aluminium, black
 Einbauleuchte; Alu, schwarz
 luminaire encastrable; aluminium, noir

H 42, Ø 88, ET 50

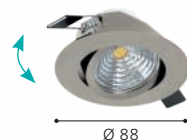



98302

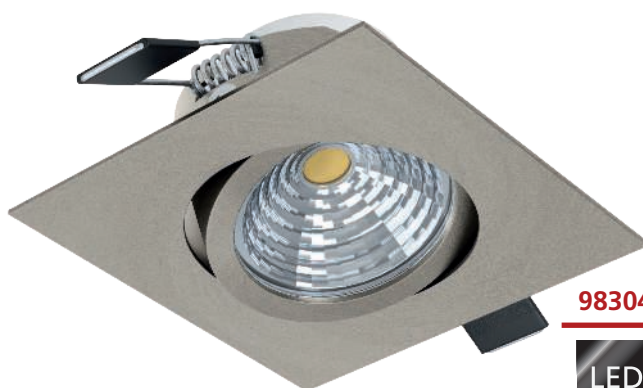

98304

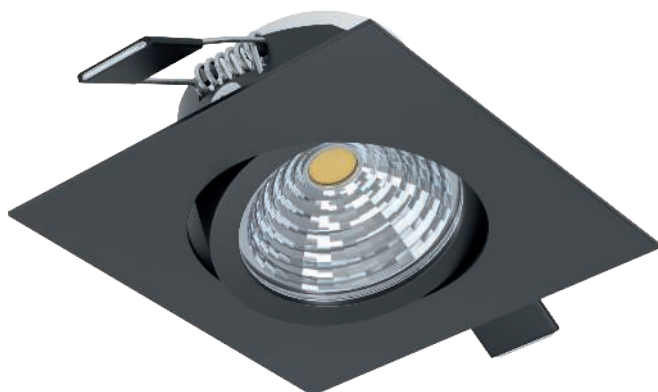

98611



98302 SALICETO

recessed light; aluminium, white
 Einbauleuchte; Alu, weiss
 luminaire encastrable; aluminium, blanc

L 88, B 88, H 42, ET 50



98304 SALICETO

recessed light; aluminium, satin nickel
 Einbauleuchte; Alu, nickel-matt
 luminaire encastrable; aluminium, nickel mat

L 88, B 88, H 42, ET 50



98611 SALICETO

recessed light; aluminium, black
 Einbauleuchte; Alu, schwarz
 luminaire encastrable; aluminium, noir

L 88, B 88, H 42, ET 50





98306

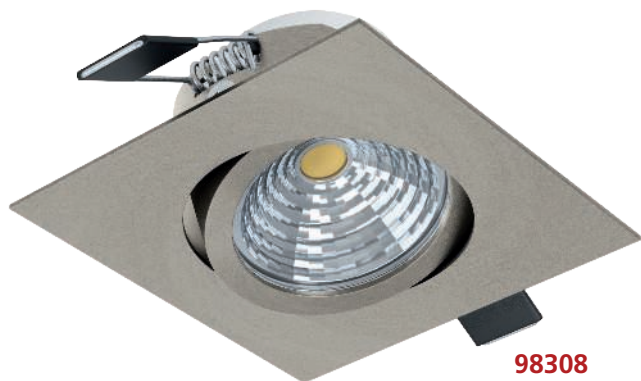

98308



98308



98306 SALICETO

recessed light; aluminium, white
 Einbauleuchte; Alu, weiss
 luminaire encastrable; aluminium, blanc

L 88, B 88, H 42, ET 50



98308 SALICETO

recessed light; aluminium, satin nickel
 Einbauleuchte; Alu, nickel-matt
 luminaire encastrable; aluminium, nickel mat

L 88, B 88, H 42, ET 50



9 002759 983062



9 002759 983086

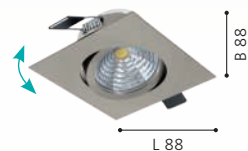



98241



IP20/44



98238



IP20/44

98238 SALABATE

recessed light; aluminium, white / glass, clear

Einbauleuchte; Alu, weiss / Glas, klar

luminaire encastrable; aluminium, blanc / verre, transparent

Ø 88, ET 52



6W



380lm



Ø68



IP44/20



9 002759 982386



Ø 88



98241



99493



99494



98241 SALABATE

recessed light; aluminium, white / glass, clear
 Einbauleuchte; Alu, weiss / Glas, klar
 luminaire encastrable; aluminium, blanc / verre, transparent

Ø 88, ET 52



6W



450lm



Ø68



IP44/20



9 002759 982416



Ø 88

99493 SALABATE

recessed light; aluminium, black / glass, clear
 Einbauleuchte; Alu, schwarz / Glas, klar
 luminaire encastrable; aluminium, noir / verre, transparent

Ø 88, ET 52



6W



380lm



Ø68



IP44/20



9 002759 994938



Ø 88

99494 SALABATE

recessed light; aluminium, black / glass, clear
 Einbauleuchte; Alu, schwarz / Glas, klar
 luminaire encastrable; aluminium, noir / verre, transparent

Ø 88, ET 52



6W



450lm



Ø68



IP44/20



9 002759 994945



Ø 88



96901



96902

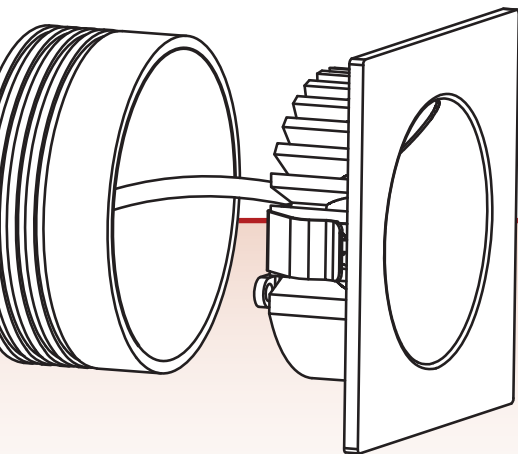

96901 ZARATE

recessed light; cast aluminium, white / plastic, white
 Einbauleuchte; Aluguss, weiss / Kunststoff, weiss
 luminaire encastrable; fonte d'aluminium, blanc / plastique, blanc

L 80, H 80, ET 40



96902 ZARATE

recessed light; cast aluminium, silver / plastic, white
 Einbauleuchte; Aluguss, silber / Kunststoff, weiss
 luminaire encastrable; fonte d'aluminium, argent / plastique, blanc

L 80, H 80, ET 40



ZARATE, MECINOS

including plaster ring

inklusive Einputzring

y compris l'anneau de plâtre





99643

LED



99644

LED



99644

LED

99643 MECINOS

recessed light; steel, white
 Einbauleuchte; Stahl, weiss
 luminaire encastrable; acier, blanc

L 80, B 80, H 3



1x 2W 90lm Ø68



9 002759 996437



99644 MECINOS

recessed light; steel, black
 Einbauleuchte; Stahl, schwarz
 luminaire encastrable; acier, noir

L 80, B 80, H 3

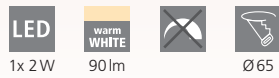

1x 2W 90lm Ø65



9 002759 996444





RECESSED DOWNLIGHTS

LOW VOLTAGE

ADVANTAGES

- > SLIM DESIGN WITH MINIMAL INSTALLATION DEPTH, MAKING IT IDEAL FOR CEILING STRUCTURES WITH LITTLE SPACE
- > UNIFORM DISTRIBUTION OF LIGHT - IDEAL FOR ILLUMINATING SPACES AND SURFACES
- > LOW TEMPERATURE ENHANCES SAFETY
- > UP TO 80% POWER SAVINGS COMPARED TO INCANDESCENT LAMPS, EASY ON YOUR BUDGET AND THE ENVIRONMENT
- > IMPL. CABLING THROUGH INTEGRATED TERMINAL CONNECTOR ON DRIVER

VORTEILE

- > SCHLANKE BAUFORM MIT MINIMALER EINBAUTIEFE, DAHER IDEAL FÜR DECKEN-KONSTRUKTIONEN MIT WENIG PLATZ
- > HOMOGENE LICHTVERTEILUNG – IDEAL ZUR BELEUCHTUNG VON RÄUMEN UND FLÄCHEN
- > GERINGE WÄRMEENTWICKLUNG SORGT FÜR MEHR SICHERHEIT
- > BIS ZU 80% STROMERSPARNIS GEGENÜBER GLÜHLAMPEN, SCHONT IHR BUDGET UND DIE UMWELT
- > EINFACHE VERKABELUNG DURCH INTEGRIERTEN KLEMMANSCHLUSS AM TREIBER

AVANTAGES

- > CONCEPTION MINCE AVEC LA PROFONDEUR D'INSTALLATION MINIMALE, IDÉAL POUR LES STRUCTURES DE PLAFOND AVEC PEU D'ESPACE
- > DISTRIBUTION UNIFORME DE LA LUMIÈRE - IDÉAL POUR L'ILLUMINATION DES ESPACES ET SURFACES
- > FAIBLE CHALEUR AMÉLIORE LA SÉCURITÉ
- > JUSQU'À 80% D'ÉCONOMIES D'ÉNERGIE PAR RAPPORT AUX LAMPES À INCANDESCENCE, RÉDUIT VOTRE BUDGET ET PROTÈGE L'ENVIRONNEMENT
- > CÂBLAGE SIMPLE VIA LE CONNECTEUR DE TERMINAL INTÉGRÉ SUR CONDUCTEUR

OVERVIEW



RONZANO 1
p. 182



FIOBBO
p. 184



CHANGO
p. 186



This product is available in different colors and shapes./ Dieser Artikel ist in unterschiedlichen Farben und Formen verfügbar.
Cet article est disponible en différentes couleurs et formes.



98521



98521 RONZANO 1

recessed light; steel, white, silver

Einbauleuchte; Stahl, weiss, silber

luminaire encastrable; acier, blanc, argent

Ø 165, ET 50

LED

5W

warm
WHITE

480lm



Ø145



9 002759 985219



Ø 165



98521

LED





97594



97593



97593 FIOBBO

recessed light; steel, white / plastic with crystal effect, white
 Einbauleuchte; Stahl, weiss / Kunststoff m. Kristalleffekt, weiss
 luminaire encastrable; acier, blanc / plastique avec effet cristal, blanc

H 50, Ø 225, ET 40



14W 1800lm

Ø 205

97594 FIOBBO

recessed light; steel, white / plastic with crystal effect, white
 Einbauleuchte; Stahl, weiss / Kunststoff m. Kristalleffekt, weiss
 luminaire encastrable; acier, blanc / plastique avec effet cristal, blanc

H 50, Ø 300, ET 40



21W 2500lm

Ø 280



9 002759 975937



Ø 225



9 002759 975944



Ø 300



97594

LED





97079



IP44

CHANGO

- | | | |
|--|---|---|
| <ul style="list-style-type: none"> > "Starry Sky" 3 Spot Set > Simple installation > Pre-assembled connecting box > Plug & Play > Desktop driver > Operable with 2 – 3 spotheads incl. short-connector > Cable length = 2 m > Cutout dimension = 16 mm | <ul style="list-style-type: none"> > "Sternenhimmel" 3 Spot Set > Einfache Montage > Vorkonfigurierte Anschlußbox > Plug & Play > Desktop Treiber > Verwendbar mit 2 – 3 Spotköpfen inkl. Verbinder > Kabellänge = 2 m > Ausschnitt Durchmesser = 16 mm | <ul style="list-style-type: none"> > Ensemble 3 spots " Ciel étoilé " > Installation simple > Boîte de connexion pré-assemblée > Branchez & jouez > Pilote de bureau > Utilisable avec 2 à 3 têtes incl. connecteur court > Longueur du câble = 2 m > Cote de découpe = 16 mm |
|--|---|---|

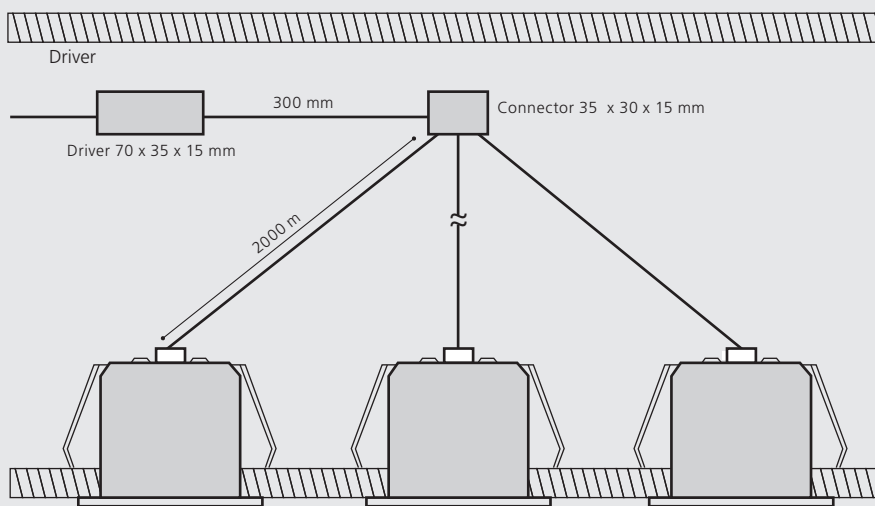

97079 CHANGO

recessed light; aluminium, white
 Einbauleuchte; Alu, weiss
 luminaire encastrable; aluminium, blanc

H 22, Ø 32, ET 25



3x 1 W



300 lm



Ø 15



IP44



9 002759 970796



Ø 32



97079

LED



IP44

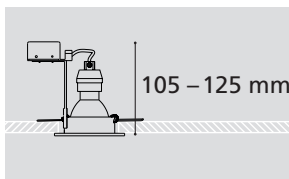

RECESSED DOWNLIGHTS

WITH SOCKET

ADVANTAGES

- > PROVEN TECHNOLOGY, CUSTOMIZED SOLUTIONS IN EVERY PRICE CATEGORY
- > DEPENDING ON THE SELECTED LAMPS APPROPRIATE FOR ILLUMINATING AREAS AND ROOMS OR FOR ACCENT LIGHTING
- > GREAT COLORS AND SHAPES
- > UP TO 80% POWER SAVINGS COMPARED TO INCANDESCENT LAMPS, EASY ON YOUR BUDGET AND THE ENVIRONMENT
- > LAMP REPLACEABLE FROM THE BOTTOM

VORTEILE

- > BEWÄHRTE TECHNOLOGIE, INDIVIDUELLE LÖSUNGEN IN JEDER PREISKLASSE
- > JE NACH EINGESETZTEM LEUCHTMITTEL ZUR BELEUCHTUNG VON FLÄCHEN UND RÄUMEN ODER ZUR AKZENTBELEUCHTUNG
- > GROSSE FARBEN- UND FORMENVIELFALT
- > BIS ZU 80% STROMERSPARNIS GEGENÜBER GLÜHLAMPEN, SCHONT IHR BUDGET UND DIE UMWELT
- > LEUCHTMITTEL VON UNTEN TAUSCHBAR

AVANTAGES

- > UNE TECHNOLOGIE ÉPROUVÉE, SOLUTIONS INDIVIDUELLES DANS CHAQUE CATÉGORIE DE PRIX
- > SELON LES LAMPES CHOISIES APTE À ÉCLAIRER DES SURFACES ET DES CHAMBRES OU POUR L'ÉCLAIRAGE ACCENTUEL
- > COULEURS ET FORMES FANTASTIQUES
- > JUSQU'À 80% D'ÉCONOMIES D'ÉNERGIE PAR RAPPORT AUX LAMPES À INCANDESCENCE, RÉDUIT VOTRE BUDGET ET PROTÈGE L'ENVIRONNEMENT
- > LAMPE REMPLAÇABLE PAR LE BAS

OVERVIEW



AREITIO
p. 190



PENETO
p. 191-195



TEDO
p. 196



TEDO 1
p. 197



CAROSSO
p. 198-201



This product is available in different colors and shapes./ Dieser Artikel ist in unterschiedlichen Farben und Formen verfügbar.
Cet article est disponible en différentes couleurs et formes.



98639 AREITIO

recessed light; aluminium, brushed aluminium
 Einbauleuchte; Alu, alu-gebürstet
 luminaire encastrable; aluminium, aluminium brossé

Ø 100

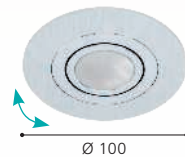

98637 AREITIO

recessed light; aluminium, brushed aluminium
 Einbauleuchte; Alu, alu-gebürstet
 luminaire encastrable; aluminium, aluminium brossé

L 95, B 95, ET 115

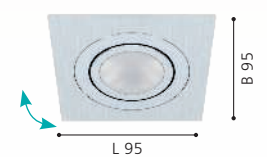



900753



900754



900753 PENETO

recessed light; steel, black
Einbauleuchte; Stahl, schwarz
luminaire encastrable; acier, noir

Ø 78, ET 115



900754 PENETO

recessed light; steel, black
Einbauleuchte; Stahl, schwarz
luminaire encastrable; acier, noir

Ø 78, ET 115

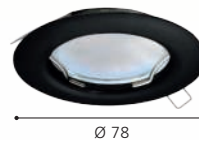



900752

LED





900751

LED



900752

LED

900751 PENETO

recessed light; steel, black
 Einbauleuchte; Stahl, schwarz
 luminaire encastrable; acier, noir

Ø 87, ET 115

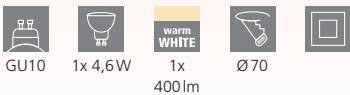

900752 PENETO

recessed light; steel, black
 Einbauleuchte; Stahl, schwarz
 luminaire encastrable; acier, noir

Ø 87, ET 115





94235 PENETO

recessed light; steel, white
Einbauleuchte; Stahl, weiss
luminaire encastrable; acier, blanc

94236 PENETO

recessed light; steel, chrome
Einbauleuchte; Stahl, chrom
luminaire encastrable; acier, chrome

94237 PENETO

recessed light; steel, satin nickel
Einbauleuchte; Stahl, nickel-matt
luminaire encastrable; acier, nickel matt

Ø 78, ET 115

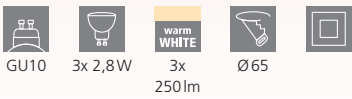

Ø 78, ET 115

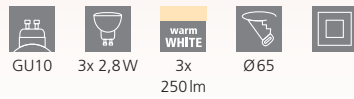

Ø 78, ET 115

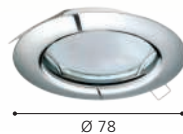
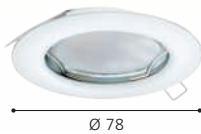



94406

LED



94407

LED



94408

LED

94406 PENETO

recessed light; steel, white
 Einbauleuchte; Stahl, weiss
 luminaire encastrable; acier, blanc

Ø 87, ET 115

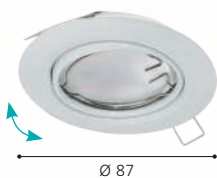

94407 PENETO

recessed light; steel, chrome
 Einbauleuchte; Stahl, chrom
 luminaire encastrable; acier, chrome

Ø 87, ET 115

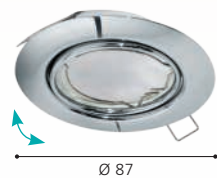

94408 PENETO

recessed light; steel, satin nickel
 Einbauleuchte; Stahl, nickel-matt
 luminaire encastrable; acier, nickel mat

Ø 87, ET 115

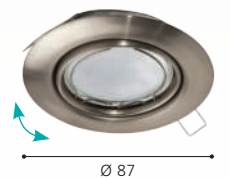



31689

LED



31683

LED



31689

LED

31683 TEDO

recessed light; cast aluminium, white
 Einbauleuchte; Aluguss, weiss
 luminaire encastrable; fonte d'aluminium, blanc

Ø 80, ET 115

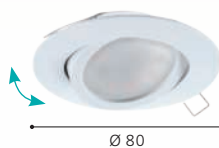

31689 TEDO

recessed light; cast aluminium, satin nickel
 Einbauleuchte; Aluguss, nickel-matt
 luminaire encastrable; fonte d'aluminium, nickel mat

Ø 80, ET 115





95359

LED

95359 TEDO 1

recessed light; cast aluminium, satin nickel

Einbauleuchte; Aluguss, nickel-matt

luminaire encastrable; fonte d'aluminium, nickel mat

Ø 80, ET 115



GU10



3x 4,8W



warm
WHITE

3x

400lm



Ø68



9 002759 953591



1



2



3



DIMMING WITHOUT A DIMMER?

There's no need for a dimmer anymore, and no need to spend money on an expensive modern LED-capable one.

The luminaire automatically switches to the next dimming level when it is switched off and on again within 3 seconds. If the luminaire stays off for more than 3 seconds, the next activation will automatically return to full lighting. You don't need to switch through all levels the next day.

Note

Our step dimming illuminants are only dimmable via the on/off switch. Operation with a conventional dimmer is not intended and may cause permanent damage to the electronics. The illuminants are therefore marked as "not dimmable" according to European regulations.

DIMMEN OHNE DIMMER?

Kein Dimmer mehr notwendig – Sie ersparen sich somit hohe Anschaffungskosten für einen modernen LED-fähigen Dimmer.

Wird die Leuchte innerhalb von 3 Sekunden aus- und wieder eingeschaltet, wechselt es automatisch in die nächste Dimmstufe. Bleibt die Leuchte länger als 3 Sekunden ausgeschaltet, stehen Ihnen beim nächsten Einschalten automatisch wieder 100 % Leuchtkraft zur Verfügung – Sie ersparen sich also das mühsame Durchschalten am nächsten Tag.

Hinweis

Unsere Stepdimming-Leuchtmittel sind nur über Ein-/Ausschalter dimmbar – der Betrieb mit konventionellen Dimmern ist nicht vorgesehen und könnte die Elektronik dauerhaft beschädigen. Die Leuchtmittel werden daher gemäß europäischer Vorschriften als „nicht dimmbar“ gekennzeichnet.

GRADUER SANS GRADUATEUR ?

Aucun graduateur n'est nécessaire – Vous vous épargnez ainsi les coûts d'acquisition élevés pour un graduateur DEL moderne.

Lorsque le luminaire est éteint, puis rallumé en l'espace de 3 secondes, il passe automatiquement au prochain niveau de graduation. Lorsque le luminaire reste éteint plus de 3 secondes, vous aurez à nouveau automatiquement 100 % de la force lumineuse lors du prochain allumage – Vous vous épargnez alors la commutation fatigante le lendemain.

Remarque

Nos ampoules à graduation par niveau sont graduable uniquement par l'interrupteur marche / arrêt – le service avec un graduateur conventionnel n'est pas prévu et pourrait endommager l'électronique à long terme. Les ampoules sont alors marquées par « non graduable », selon les réglementations européenne.



900815



900815

900815 CAROSSO

recessed light; aluminium, black, white
Einbauleuchte; Alu, schwarz, weiss
luminaire encastrable; aluminium, noir, blanc

H 28, Ø 93



GU10



1x 35W



Ø 80



9 008606 259236



RECESSED



Ø 93



900816



900454

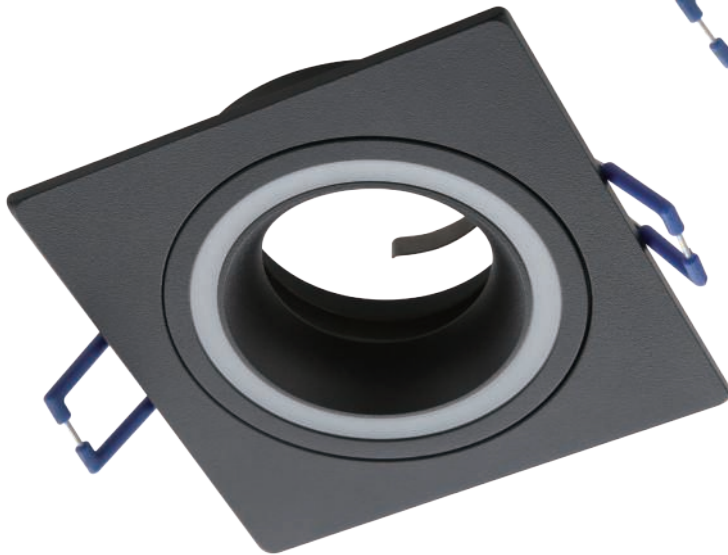

900451

900451 CAROSSO

recessed light; aluminium, black / plastic, white
 Einbauleuchte; Alu, schwarz / Kunststoff, weiss
 luminaire encastrable; aluminium, noir / plastique, blanc

L 93, B 93, H 25



900816 CAROSSO

recessed light; aluminium, white
 Einbauleuchte; Alu, weiss
 luminaire encastrable; aluminium, blanc

H 28, Ø 93



900454 CAROSSO

recessed light; aluminium, white / plastic, white
 Einbauleuchte; Alu, weiss / Kunststoff, weiss
 luminaire encastrable; aluminium, blanc / plastique, blanc

L 93, B 93, H 25

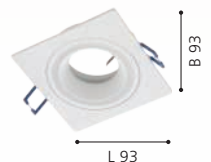
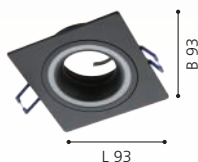



900453

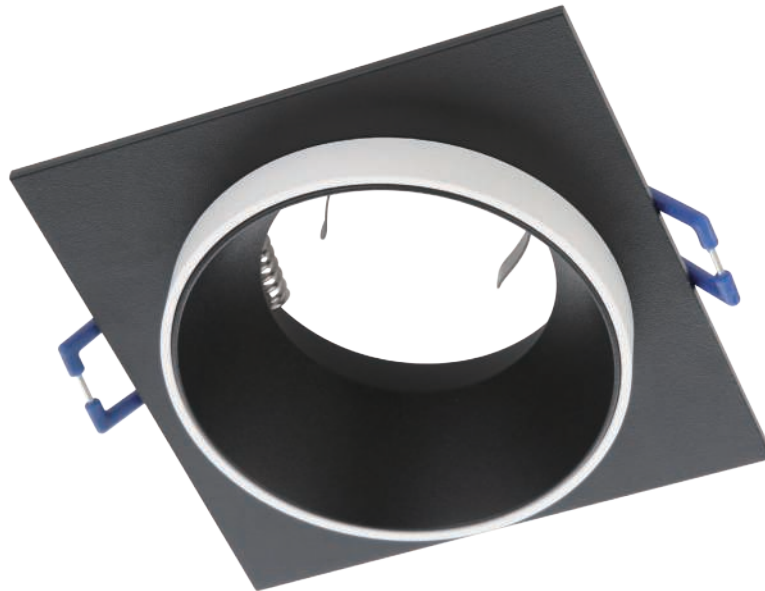

900452

900453 CAROSSO

recessed light; aluminium, black, white
 Einbauleuchte; Alu, schwarz, weiss
 luminaire encastrable; aluminium, noir, blanc

H 35, Ø 93

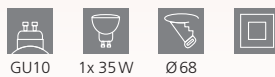

GU10 1x 35W Ø68



9 008606 238781



Ø 93

900452 CAROSSO

recessed light; aluminium, black, white
 Einbauleuchte; Alu, schwarz, weiss
 luminaire encastrable; aluminium, noir, blanc

L 93, B 93, H 25



GU10 1x 35W Ø68



9 008606 238774

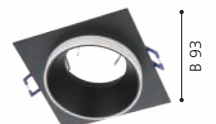

L 93

B 93



900456 CAROSSO

recessed light; aluminium, white, black
 Einbauleuchte; Alu, weiss, schwarz
 luminaire encastrable; aluminium, blanc, noir

H 35, Ø 93



900455 CAROSSO

recessed light; aluminium, white, black
 Einbauleuchte; Alu, weiss, schwarz
 luminaire encastrable; aluminium, blanc, noir

L 93, B 93, H 25

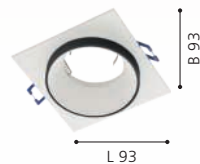

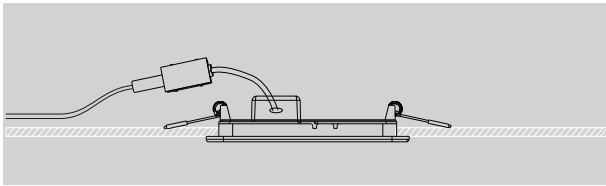

RECESSED DOWNLIGHTS

FUEVA

ADVANTAGES

- > MODERN APPEARANCE - THE FUEVA CONVINCES WITH ITS FLAT DESIGN AND NARROW FRAME
 - > AVAILABLE IN DIFFERENT VARIATIONS (COLOUR, SHAPE, IP CLASS)
 - > INCLUSIVE PLUG-IN TERMINAL - FOR QUICK WORK AND EASY HANDLING
-

VORTEILE

- > MODERNES ERSCHEINUNGSBILD - DIE FUEVA ÜBERZEUGT DURCH IHR FLACHES DESIGN SOWIE DEN SCHMALEN RAHMEN
 - > ERHÄLTlich IN VERSCHIEDENEN VARIATIONEN (FARBE, FORM, IP KLASSE)
 - > INKLUSIVE STECKKLEMME - FÜR DAS SCHNELLE ARBEITEN UND EINE EINFACHE HANDHABUNG
-

AVANTAGES

- > APPARENCE MODERNE - LE FUEVA CONVAINC PAR SON DESIGN PLAT ET SON CADRE ÉTROIT
- > DISPONIBLE EN DIFFÉRENTES VARIATIONS (COULEUR, FORME, CLASSE IP)
- > Y COMPRIS UNE BORNE ENFICHABLE - POUR UN TRAVAIL RAPIDE ET UNE MANIPULATION SIMPLE

OVERVIEW



FUEVA 5
p. 204 - 229



FUEVA FLEX
p. 230 - 231



This product is available in different colors and shapes./ Dieser Artikel ist in unterschiedlichen Farben und Formen verfügbar.
Cet article est disponible en différentes couleurs et formes.



99131



99133



99132



99131 FUEVA 5

recessed light; steel, white / plastic, white
Einbauleuchte; Stahl, weiss / Kunststoff, weiss
luminaire encastrable; acier, blanc / plastique, blanc

Ø 86, ET 26



2,7W 330lm

Ø 75

99132 FUEVA 5

recessed light; steel, white / plastic, white
Einbauleuchte; Stahl, weiss / Kunststoff, weiss
luminaire encastrable; acier, blanc / plastique, blanc

Ø 117, ET 26



5,5W 650lm

Ø 105

99133 FUEVA 5

recessed light; steel, white / plastic, white
Einbauleuchte; Stahl, weiss / Kunststoff, weiss
luminaire encastrable; acier, blanc / plastique, blanc

Ø 166, ET 26



11W 1350lm

Ø 155



9 002759 991319



Ø 86



9 002759 991326



Ø 117



9 002759 991333



Ø 166



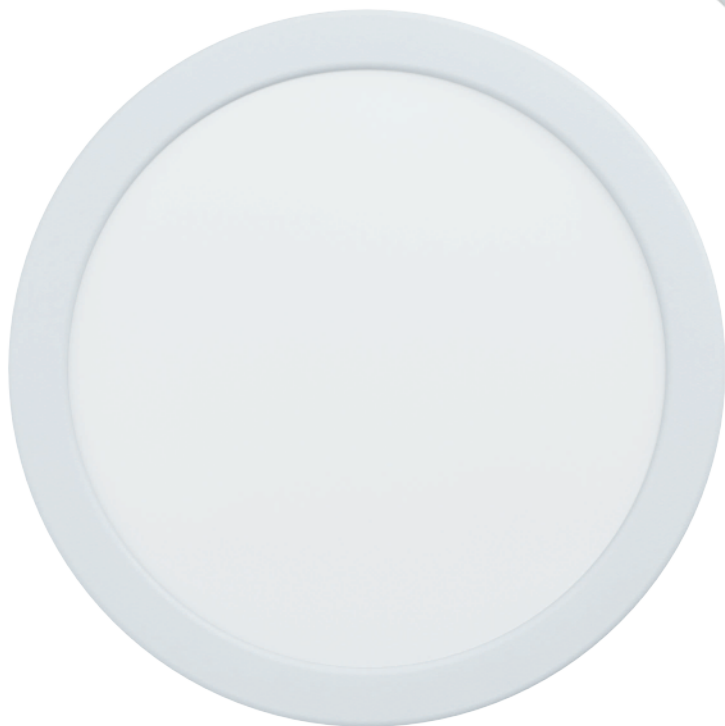

99134

LED



99135

LED

99134 FUEVA 5

recessed light; steel, white / plastic, white
Einbauleuchte; Stahl, weiss / Kunststoff, weiss
luminaire encastrable; acier, blanc / plastique, blanc

Ø 216, ET 26

LED

17W

warm
WHITE

2000lm



Ø205



99135 FUEVA 5

recessed light; steel, white / plastic, white
Einbauleuchte; Stahl, weiss / Kunststoff, weiss
luminaire encastrable; acier, blanc / plastique, blanc

Ø 86, ET 26

LED

3x 2,7W

warm
WHITE

990lm



Ø75



9 002759 991340



Ø 216



9 002759 991357



Ø 86





99136



99138



99137



99136 FUEVA 5

recessed light; steel, satin nickel / plastic, white
Einbauleuchte; Stahl, nickel-matt / Kunststoff, weiss
luminaire encastrable; acier, nickel mat / plastique, blanc

Ø 86, ET 26



2,7W 330lm

Ø 75



9 002759 991364



Ø 86

99137 FUEVA 5

recessed light; steel, satin nickel / plastic, white
Einbauleuchte; Stahl, nickel-matt / Kunststoff, weiss
luminaire encastrable; acier, nickel mat / plastique, blanc

Ø 117, ET 26



5,5W 650lm

Ø 105



9 002759 991371



Ø 117

99138 FUEVA 5

recessed light; steel, satin nickel / plastic, white
Einbauleuchte; Stahl, nickel-matt / Kunststoff, weiss
luminaire encastrable; acier, nickel mat / plastique, blanc

Ø 166, ET 26



11W 1350lm

Ø 155



9 002759 991388



Ø 166



99139

LED



99141

LED

99139 FUEVA 5

recessed light; steel, satin nickel / plastic, white
Einbauleuchte; Stahl, nickel-matt / Kunststoff, weiss
luminaire encastrable; acier, nickel mat / plastique, blanc

Ø 216, ET 26

LED

17W

warm
WHITE

2000lm



Ø205



9 002759 991395



Ø 216



99141 FUEVA 5

recessed light; steel, satin nickel / plastic, white
Einbauleuchte; Stahl, nickel-matt / Kunststoff, weiss
luminaire encastrable; acier, nickel mat / plastique, blanc

Ø 86, ET 26

LED

3x 2,7W

warm
WHITE

990lm



Ø75



9 002759 991418



Ø 86





99142



99144



99143



99142 FUEVA 5

recessed light; steel, black / plastic, white
Einbauleuchte; Stahl, schwarz / Kunststoff, weiss
luminaire encastrable; acier, noir / plastique, blanc

Ø 86, ET 26



2,7W 330lm

Ø 75



9 002759 991425



Ø 86

99143 FUEVA 5

recessed light; steel, black / plastic, white
Einbauleuchte; Stahl, schwarz / Kunststoff, weiss
luminaire encastrable; acier, noir / plastique, blanc

Ø 117, ET 26



5,5W 650lm

Ø 105



9 002759 991432



Ø 117

99144 FUEVA 5

recessed light; steel, black / plastic, white
Einbauleuchte; Stahl, schwarz / Kunststoff, weiss
luminaire encastrable; acier, noir / plastique, blanc

Ø 166, ET 26



11W 1350lm

Ø 155



9 002759 991449



Ø 166



99145



99146



99145 FUEVA 5

recessed light; steel, black / plastic, white
Einbauleuchte; Stahl, schwarz / Kunststoff, weiss
luminaire encastrable; acier, noir / plastique, blanc

Ø 216, ET 26

LED

17W

warm
WHITE

2000lm



Ø205



9 002759 991456



Ø 216



99146 FUEVA 5

recessed light; steel, black / plastic, white
Einbauleuchte; Stahl, schwarz / Kunststoff, weiss
luminaire encastrable; acier, noir / plastique, blanc

Ø 86, ET 26

LED

3x 2,7W

warm
WHITE

990lm



Ø75



9 002759 991463



Ø 86





99147



99149



99148



99147 FUEVA 5

recessed light; steel, white / plastic, white
Einbauleuchte; Stahl, weiss / Kunststoff, weiss
luminaire encastrable; acier, blanc / plastique, blanc

Ø 86, ET 26



2,7W 330lm

Ø 75

99148 FUEVA 5

recessed light; steel, white / plastic, white
Einbauleuchte; Stahl, weiss / Kunststoff, weiss
luminaire encastrable; acier, blanc / plastique, blanc

Ø 117, ET 26



5,5W 700lm

Ø 105

99149 FUEVA 5

recessed light; steel, white / plastic, white
Einbauleuchte; Stahl, weiss / Kunststoff, weiss
luminaire encastrable; acier, blanc / plastique, blanc

Ø 166, ET 26



11W 1350lm

Ø 155



9 002759 991470



Ø 86



9 002759 991487



Ø 117



9 002759 991494



Ø 166



99151

LED



99151

LED

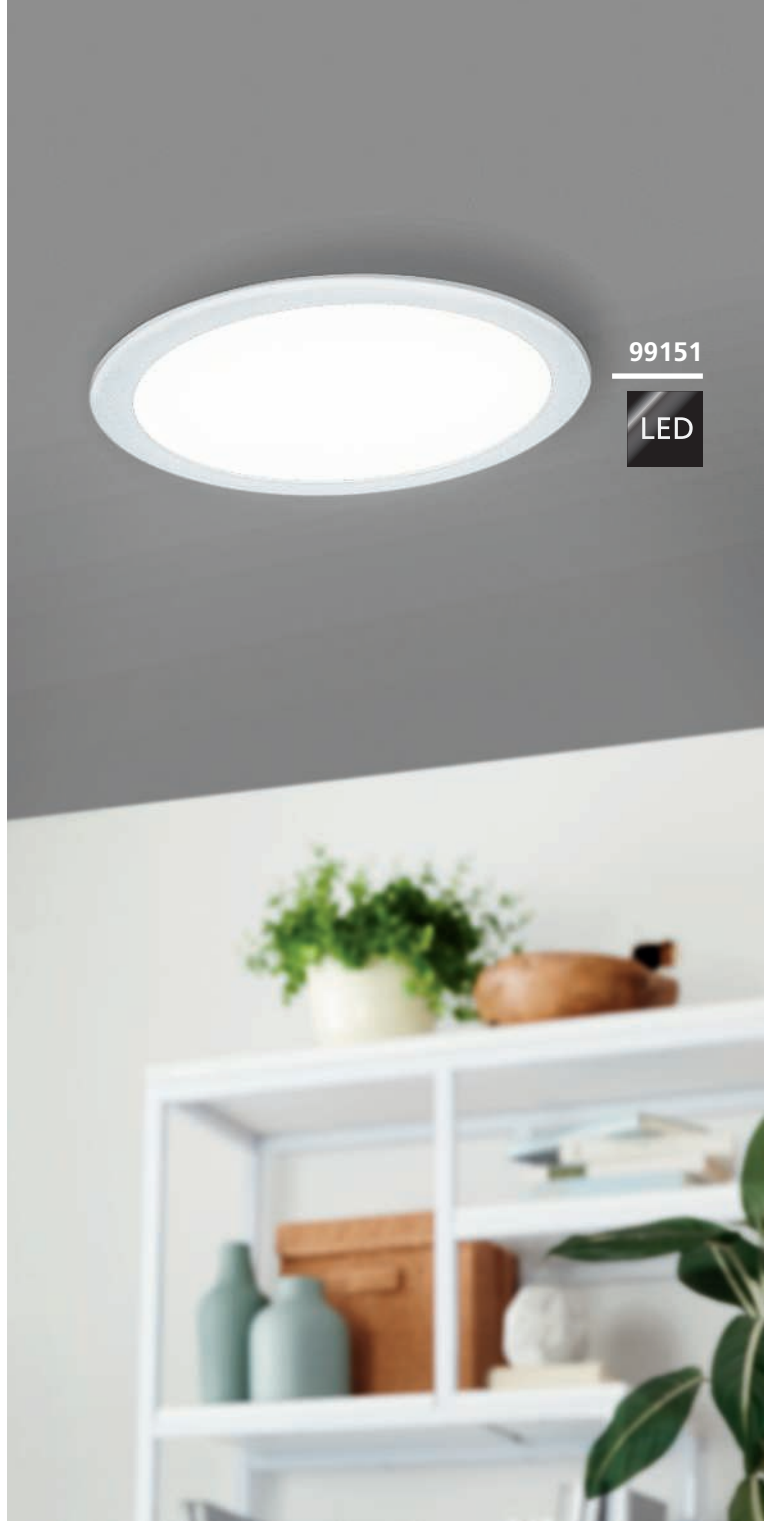

99151 FUEVA 5

recessed light; steel, white / plastic, white
Einbauleuchte; Stahl, weiss / Kunststoff, weiss
luminaire encastrable; acier, blanc / plastique, blanc

Ø 216, ET 26

LED

17W

neutral
WHITE

2100lm



Ø205



9 002759 991517



Ø 216



99152



99154



99153



99152 FUEVA 5

recessed light; steel, satin nickel / plastic, white
Einbauleuchte; Stahl, nickel-matt / Kunststoff, weiss
luminaire encastrable; acier, nickel mat / plastique, blanc

Ø 86, ET 26



2,7W 330lm

Ø 75



9 002759 991524



Ø 86

99153 FUEVA 5

recessed light; steel, satin nickel / plastic, white
Einbauleuchte; Stahl, nickel-matt / Kunststoff, weiss
luminaire encastrable; acier, nickel mat / plastique, blanc

Ø 117, ET 26



5,5W 700lm

Ø 105



9 002759 991531



Ø 117

99154 FUEVA 5

recessed light; steel, satin nickel / plastic, white
Einbauleuchte; Stahl, nickel-matt / Kunststoff, weiss
luminaire encastrable; acier, nickel mat / plastique, blanc

Ø 166, ET 26



11W 1350lm

Ø 155



9 002759 991548



Ø 166



99155

LED



99155

LED

99155 FUEVA 5

recessed light; steel, satin nickel / plastic, white
Einbauleuchte; Stahl, nickel-matt / Kunststoff, weiss
luminaire encastrable; acier, nickel mat / plastique, blanc

Ø 216, ET 26

LED

17W

neutral
WHITE

2100lm



Ø205



Ø 216



99156



99158



99157



99156 FUEVA 5

recessed light; steel, black / plastic, white
Einbauleuchte; Stahl, schwarz / Kunststoff, weiss
luminaire encastrable; acier, noir / plastique, blanc

Ø 86, ET 26



2,7W 330lm

Ø 75

99157 FUEVA 5

recessed light; steel, black / plastic, white
Einbauleuchte; Stahl, schwarz / Kunststoff, weiss
luminaire encastrable; acier, noir / plastique, blanc

Ø 117, ET 26



5,5W 700lm

Ø 105

99158 FUEVA 5

recessed light; steel, black / plastic, white
Einbauleuchte; Stahl, schwarz / Kunststoff, weiss
luminaire encastrable; acier, noir / plastique, blanc

Ø 166, ET 26



11W 1350lm

Ø 155



9 002759 991562



Ø 86



9 002759 991579



Ø 117



9 002759 991586



Ø 166





99159

LED



99158

LED

99159 FUEVA 5

recessed light; steel, black / plastic, white
Einbauleuchte; Stahl, schwarz / Kunststoff, weiss
luminaire encastrable; acier, noir / plastique, blanc

Ø 216, ET 26

LED

17W

neutral
WHITE

2100lm



Ø205



9 002759 991593



Ø 216

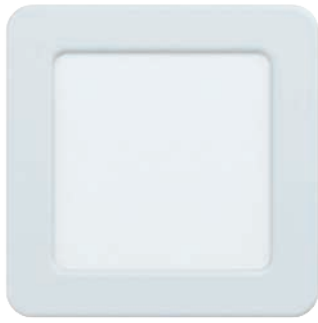

99162



99164



99163



99162 FUEVA 5

recessed light; steel, white / plastic, white
Einbauleuchte; Stahl, weiss / Kunststoff, weiss
luminaire encastrable; acier, blanc / plastique, blanc

L 117, B 117, ET 26



5,5W 650lm 105x105



9 002759 991623



L 117



9 002759 991630



L 166, B 166, ET 26



11W 1350lm 155x155

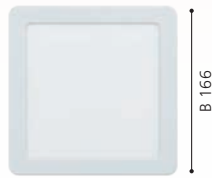

L 166

99164 FUEVA 5

recessed light; steel, white / plastic, white
Einbauleuchte; Stahl, weiss / Kunststoff, weiss
luminaire encastrable; acier, blanc / plastique, blanc

L 216, B 216, ET 26



17W 2000lm 205x205



9 002759 991647

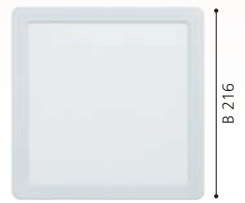

L 216



99167

LED



99169

LED



99168

LED

99167 FUEVA 5

recessed light; steel, satin nickel / plastic, white
Einbauleuchte; Stahl, nickel-matt / Kunststoff, weiss
luminaire encastrable; acier, nickel mat / plastique, blanc

L 117, B 117, ET 26



5,5W

650lm

105x105



9 002759 991678



L 117

B 117

99168 FUEVA 5

recessed light; steel, satin nickel / plastic, white
Einbauleuchte; Stahl, nickel-matt / Kunststoff, weiss
luminaire encastrable; acier, nickel mat / plastique, blanc

L 166, B 166, ET 26



11W

1350lm

155x155



9 002759 991685



L 166

B 166

99169 FUEVA 5

recessed light; steel, satin nickel / plastic, white
Einbauleuchte; Stahl, nickel-matt / Kunststoff, weiss
luminaire encastrable; acier, nickel mat / plastique, blanc

L 216, B 216, ET 26



17W

2000lm

205x205



9 002759 991692



L 216

B 216



99178

LED



99181

LED



99179

LED

99178 FUEVA 5

recessed light; steel, white / plastic, white
Einbauleuchte; Stahl, weiss / Kunststoff, weiss
luminaire encastrable; acier, blanc / plastique, blanc

L 117, B 117, ET 26



5,5W 700lm 105x105

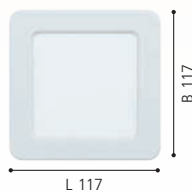

99179 FUEVA 5

recessed light; steel, white / plastic, white
Einbauleuchte; Stahl, weiss / Kunststoff, weiss
luminaire encastrable; acier, blanc / plastique, blanc

L 166, B 166, ET 26



11W 1350lm 155x155

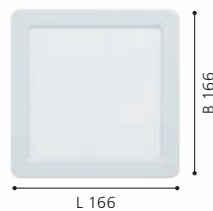

99181 FUEVA 5

recessed light; steel, white / plastic, white
Einbauleuchte; Stahl, weiss / Kunststoff, weiss
luminaire encastrable; acier, blanc / plastique, blanc

L 216, B 216, ET 26



17W 2100lm 205x205

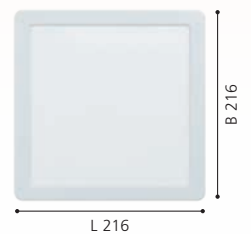



99183

LED



99185

LED



99184

LED

99183 FUEVA 5

recessed light; steel, satin nickel / plastic, white
Einbauleuchte; Stahl, nickel-matt / Kunststoff, weiss
luminaire encastrable; acier, nickel mat / plastique, blanc

L 117, B 117, ET 26



5,5W

700lm

105x105

99184 FUEVA 5

recessed light; steel, satin nickel / plastic, white
Einbauleuchte; Stahl, nickel-matt / Kunststoff, weiss
luminaire encastrable; acier, nickel mat / plastique, blanc

L 166, B 166, ET 26



11W

1350lm

155x155

99185 FUEVA 5

recessed light; steel, satin nickel / plastic, white
Einbauleuchte; Stahl, nickel-matt / Kunststoff, weiss
luminaire encastrable; acier, nickel mat / plastique, blanc

L 216, B 216, ET 26



17W

2100lm

205x205



9 002759 991838



L 117

B 117



9 002759 991845



L 166

B 166



9 002759 991852



L 216

B 216



99187

LED





99187

LED



99189

LED



99188

LED

99187 FUEVA 5

recessed light; steel, black / plastic, white
Einbauleuchte; Stahl, schwarz / Kunststoff, weiss
luminaire encastrable; acier, noir / plastique, blanc

L 117, B 117, ET 26



5,5W 700lm 105x105



L 117

99188 FUEVA 5

recessed light; steel, black / plastic, white
Einbauleuchte; Stahl, schwarz / Kunststoff, weiss
luminaire encastrable; acier, noir / plastique, blanc

L 166, B 166, ET 26



11W 1350lm 155x155



L 166

99189 FUEVA 5

recessed light; steel, black / plastic, white
Einbauleuchte; Stahl, schwarz / Kunststoff, weiss
luminaire encastrable; acier, noir / plastique, blanc

L 216, B 216, ET 26



17W 2100lm 205x205



L 216



99191

LED





99191

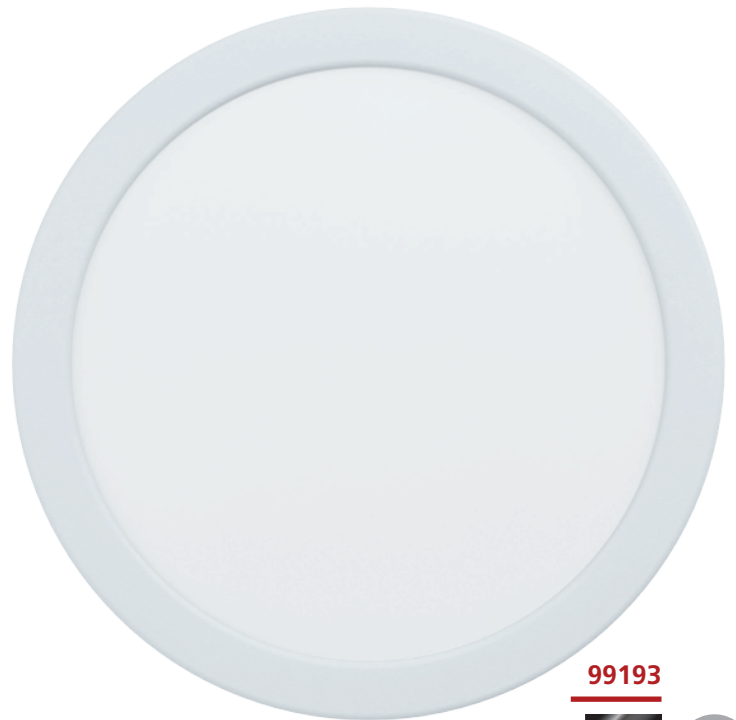

99193



99192



99191 FUEVA 5

recessed light; steel, white / plastic, white
Einbauleuchte; Stahl, weiss / Kunststoff, weiss
luminaire encastrable; acier, blanc / plastique, blanc

Ø 117, ET 26



5,5W



650lm



Ø 105



99192 FUEVA 5

recessed light; steel, white / plastic, white
Einbauleuchte; Stahl, weiss / Kunststoff, weiss
luminaire encastrable; acier, blanc / plastique, blanc

Ø 166, ET 26



11W



1350lm



Ø 155



99193 FUEVA 5

recessed light; steel, white / plastic, white
Einbauleuchte; Stahl, weiss / Kunststoff, weiss
luminaire encastrable; acier, blanc / plastique, blanc

Ø 216, ET 26



17W



2000lm



Ø 205



9 002759 991913



Ø 117



9 002759 991920



Ø 166



9 002759 991937



Ø 216



99202



IP44



99203



IP44



99206



IP44

99202 FUEVA 5

recessed light; steel, white / plastic, white
Einbauleuchte; Stahl, weiss / Kunststoff, weiss
luminaire encastrable; acier, blanc / plastique, blanc

99206 FUEVA 5

recessed light; steel, white / plastic, white
Einbauleuchte; Stahl, weiss / Kunststoff, weiss
luminaire encastrable; acier, blanc / plastique, blanc

99203 FUEVA 5

recessed light; steel, white / plastic, white
Einbauleuchte; Stahl, weiss / Kunststoff, weiss
luminaire encastrable; acier, blanc / plastique, blanc

Ø 86, ET 26



2,7W 330lm Ø75 IP44



9 002759 992026



Ø 86

Ø 86, ET 26



2,7W 330lm Ø75 IP44



9 002759 992064



Ø 86

Ø 166, ET 26



11W 1350lm Ø155 IP44



9 002759 992033



Ø 166



99207

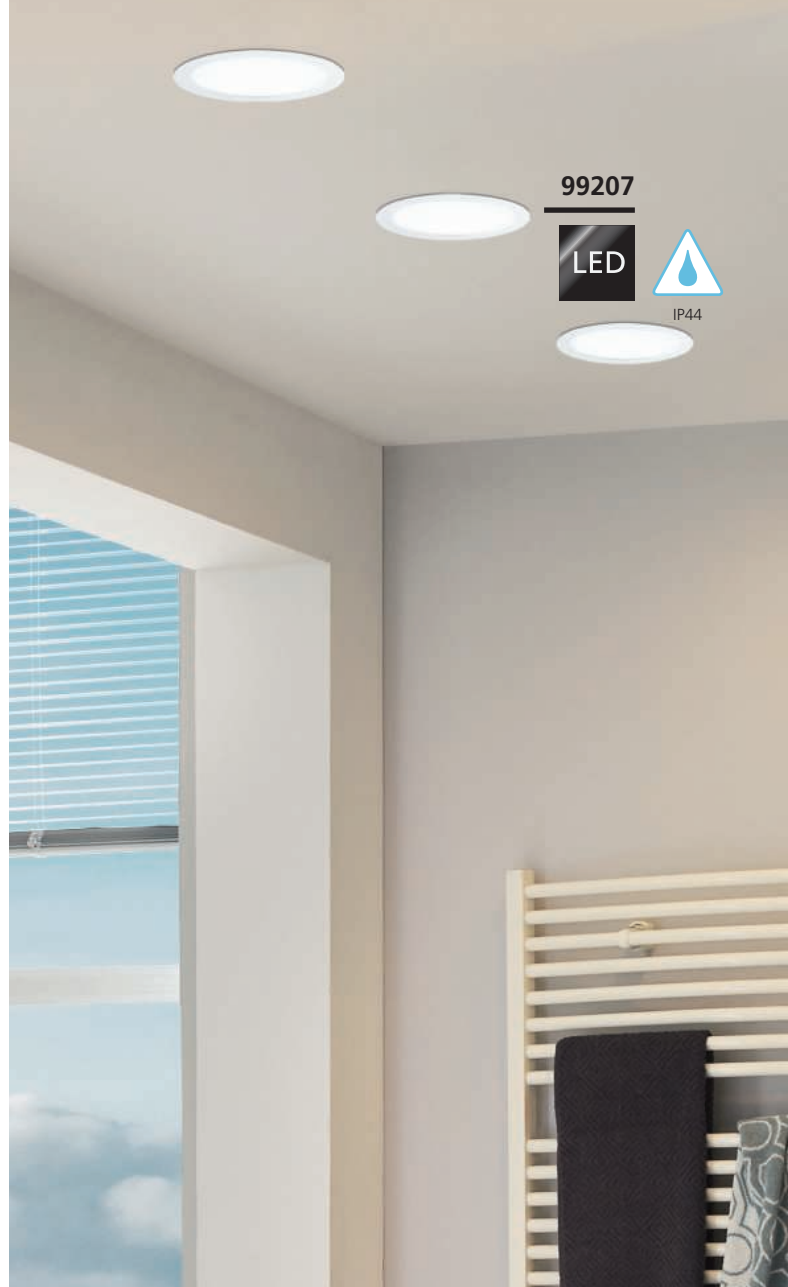

99207



99207 FUEVA 5

recessed light; steel, white / plastic, white
 Einbauleuchte; Stahl, weiss / Kunststoff, weiss
 luminaire encastrable; acier, blanc / plastique, blanc

Ø 166, ET 26



FUEVA 5

These luminaires are protected against splash water.

Diese Leuchten sind gegen Spritzwasser geschützt.

Les luminaires sont protégées contre les éclaboussures d'eau.

	0	1	2	3
EU	X	X	✓	✓
FR	X	X	X	✓

IP44





99204



IP44



99205



IP44



99208



IP44

99204 FUEVA 5

recessed light; steel, chrome / plastic, white
Einbauleuchte; Stahl, chrom / Kunststoff, weiss
luminaire encastrable; acier, chrome / plastique, blanc

99208 FUEVA 5

recessed light; steel, chrome / plastic, white
Einbauleuchte; Stahl, chrom / Kunststoff, weiss
luminaire encastrable; acier, chrome / plastique, blanc

99205 FUEVA 5

recessed light; steel, chrome / plastic, white
Einbauleuchte; Stahl, chrom / Kunststoff, weiss
luminaire encastrable; acier, chrome / plastique, blanc

Ø 86, ET 26



9 002759 992040



Ø 86

Ø 86, ET 26



9 002759 992088



Ø 86

Ø 166, ET 26



9 002759 992057



Ø 166



99209



99209 FUEVA 5

recessed light; steel, chrome / plastic, white
Einbauleuchte; Stahl, chrom / Kunststoff, weiss
luminaire encastrable; acier, chrome / plastique, blanc

Ø 166, ET 26

LED

11 W

neutral
WHITE

1350 lm



Ø 155



IP44



9 002759 992095



Ø 166



99204



IP44



99211



IP44



99212



IP44



99213



IP44

99211 FUEVA 5

recessed light; steel, black / plastic, white
Einbauleuchte; Stahl, schwarz / Kunststoff, weiss
luminaire encastrable; acier, noir / plastique, blanc

99213 FUEVA 5

recessed light; steel, black / plastic, white
Einbauleuchte; Stahl, schwarz / Kunststoff, weiss
luminaire encastrable; acier, noir / plastique, blanc

99212 FUEVA 5

recessed light; steel, black / plastic, white
Einbauleuchte; Stahl, schwarz / Kunststoff, weiss
luminaire encastrable; acier, noir / plastique, blanc

Ø 86, ET 26



2,7W 330lm Ø75 IP44



9 002759 992118



Ø 86

Ø 86, ET 26



2,7W 330lm Ø75 IP44



9 002759 992132



Ø 86

Ø 166, ET 26



11W 1350lm Ø155 IP44



9 002759 992125



Ø 166





99214



IP44



99211



IP44

99214 FUEVA 5

recessed light; steel, black / plastic, white
Einbauleuchte; Stahl, schwarz / Kunststoff, weiss
luminaire encastrable; acier, noir / plastique, blanc

Ø 166, ET 26

LED

11 W

neutral
WHITE

1350 lm



Ø 155



IP44



Ø 166



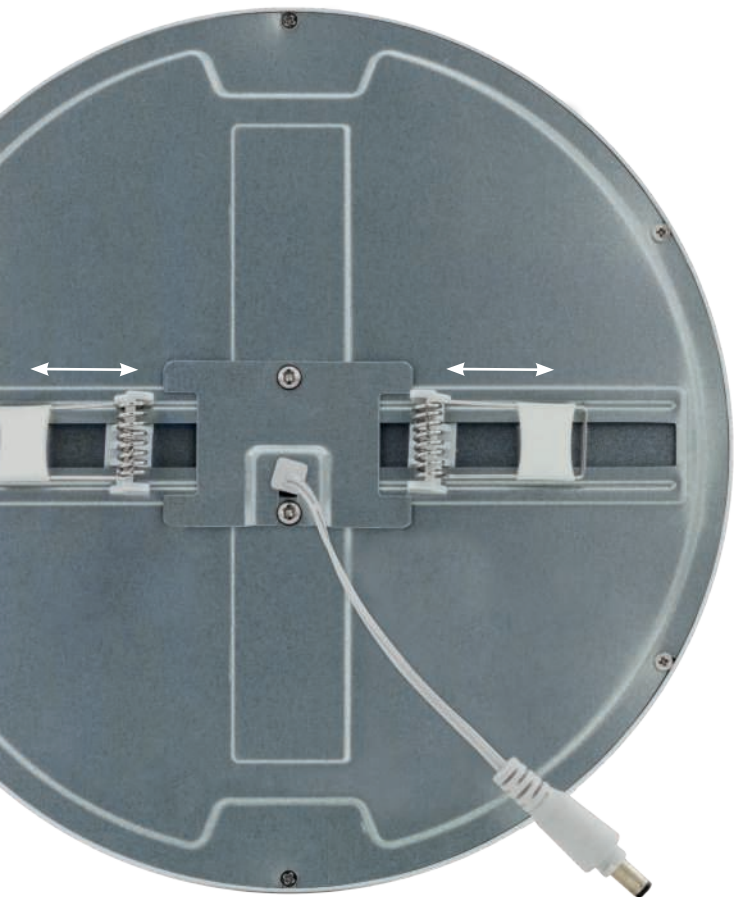

FUEVA FLEX

Flexible mounting bracket for various ceiling cut-outs from 50-210 mm.

Flexibler Einbaubügel für verschiedene Deckenausschnitte von 50-210 mm.

Support de montage flexible pour différentes découpes de plafond de 50 à 210 mm.



98865

LED



98866

LED



98867

LED

98865 FUEVA FLEX

recessed light; aluminium, white / plastic, white
Einbauleuchte; Alu, weiss / Kunststoff, weiss
luminaire encastrable; aluminium, blanc / plastique, blanc

H 25, Ø 225



98866 FUEVA FLEX

recessed light; aluminium, satin nickel / plastic, white
Einbauleuchte; Alu, nickel-matt / Kunststoff, weiss
luminaire encastrable; aluminium, nickel mat / plastique, blanc

H 25, Ø 225



98867 FUEVA FLEX

recessed light; aluminium, black / plastic, white
Einbauleuchte; Alu, schwarz / Kunststoff, weiss
luminaire encastrable; aluminium, noir / plastique, blanc

H 25, Ø 225





98868



98869



98871



98871



98868 FUEVA FLEX

recessed light; aluminium, white / plastic, white
Einbauleuchte; Alu, weiss / Kunststoff, weiss
luminaire encastrable; aluminium, blanc / plastique, blanc

H 25, Ø 225



22W



2800lm



Ø 70-200



98869 FUEVA FLEX

recessed light; aluminium, satin nickel / plastic, white
Einbauleuchte; Alu, nickel-matt / Kunststoff, weiss
luminaire encastrable; aluminium, nickel mat / plastique, blanc

H 25, Ø 225



22W



2800lm



Ø 70-200



98871 FUEVA FLEX

recessed light; aluminium, black / plastic, white
Einbauleuchte; Alu, schwarz / Kunststoff, weiss
luminaire encastrable; aluminium, noir / plastique, blanc

H 25, Ø 225



22W



2800lm



Ø 70-200



9 002759 988685



Ø 225



9 002759 988692



Ø 225



9 002759 988715



Ø 225

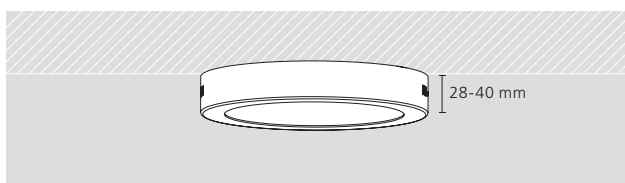

SURFACE DOWNLIGHTS

FUEVA

ADVANTAGES

- > SLIM DESIGN WITH LOW SURFACE HEIGHT (28 TO 40 MM)
- > AVAILABLE IN VARIOUS COLOURS, SHAPES AND IP CLASSES.
- > LOW TEMPERATURE ENHANCES SAFETY
- > UP TO 80% POWER SAVINGS COMPARED TO INCANDESCENT LAMPS, EASY ON YOUR BUDGET AND THE ENVIRONMENT

VORTEILE

- > SCHLANKE BAUFORM MIT GERINGER AUFBAUHÖHE (28 BIS 40 MM)
- > ERHÄLTICH IN VERSCHIEDENEN FARBEN, FORMEN UND IP-KLASSEN.
- > GERINGE WÄRMEENTWICKLUNG SORGT FÜR MEHR SICHERHEIT
- > BIS ZU 80% STROMERSPARNIS GEGENÜBER GLÜHLAMPEN, SCHONT IHR BUDGET UND DIE UMWELT

AVANTAGES

- > CONCEPTION MINCE AVEC LA HAUTEUR DE SAILIE MINIMALE (DE 28 À 40 MM)
- > DISPONIBLE EN DIFFÉRENTES COULEURS, FORMES ET CLASSES IP.
- > FAIBLE CHALEUR AMÉLIORE LA SÉCURITÉ
- > JUSQU'À 80% D'ÉCONOMIES D'ÉNERGIE PAR RAPPORT AUX LAMPES À INCANDESCENCE, RÉDUIT VOTRE BUDGET ET PROTÈGE L'ENVIRONNEMENT

OVERVIEW



FUEVA 5
p.235-267



FUEVA 1
p.268-271



This product is available in different colors and shapes./ Dieser Artikel ist in unterschiedlichen Farben und Formen verfügbar.
Cet article est disponible en différentes couleurs et formes.

FUEVA 5



FEATURES

Quick Connector
Schnellverbinder
Connecteur rapide

FLICKER FREE
FLICKER FREI
FLICKER FREE

DESIGN

Flat design from originally 40 mm
high to **28** mm high
Flaches Design von ursprünglich 40 mm
Höhe auf **28** mm Höhe
Design plat de 40 mm de haut à
28 mm de haut

Narrow frame from 21 mm to **15** mm
Schmäler Rahmen von 21 mm auf **15** mm
Cadre étroit de 21 mm vers **15** mm

Modern appearance
Modernerer Erscheinungsbild
Apparence plus moderne



99215



99217



99216



99215 FUEVA 5

surface-mounted light; steel, white / plastic, white
Aufbauleuchte; Stahl, weiss / Kunststoff, weiss
luminaire en saillie; acier, blanc / plastique, blanc

H 28, Ø 160



11W 1350lm

99216 FUEVA 5

surface-mounted light; steel, white / plastic, white
Aufbauleuchte; Stahl, weiss / Kunststoff, weiss
luminaire en saillie; acier, blanc / plastique, blanc

H 28, Ø 210



17W 2000lm

99217 FUEVA 5

surface-mounted light; steel, white / plastic, white
Aufbauleuchte; Stahl, weiss / Kunststoff, weiss
luminaire en saillie; acier, blanc / plastique, blanc

H 28, Ø 285



20,5W 2400lm



9 002759 992156

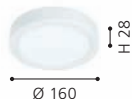

Ø 160



9 002759 992163



Ø 210



9 002759 992170



Ø 285



99218



99221



99219



99218 FUEVA 5

surface-mounted light; steel, satin nickel / plastic, white
Aufbauleuchte; Stahl, nickel-matt / Kunststoff, weiss
luminaire en saillie; acier, nickel mat / plastique, blanc

H 28, Ø 160



11W 1350lm

99219 FUEVA 5

surface-mounted light; steel, satin nickel / plastic, white
Aufbauleuchte; Stahl, nickel-matt / Kunststoff, weiss
luminaire en saillie; acier, nickel mat / plastique, blanc

H 28, Ø 210



17W 2000lm

99221 FUEVA 5

surface-mounted light; steel, satin nickel / plastic, white
Aufbauleuchte; Stahl, nickel-matt / Kunststoff, weiss
luminaire en saillie; acier, nickel mat / plastique, blanc

H 28, Ø 285



20,5W 2400lm



9 002759 992187

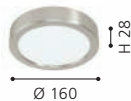

9 002759 992194



9 002759 992217





99222



99224



99223



99222 FUEVA 5

surface-mounted light; steel, black / plastic, white
Aufbauleuchte; Stahl, schwarz / Kunststoff, weiss
luminaire en saillie; acier, noir / plastique, blanc

H 28, Ø 160



11 W 1350lm

99223 FUEVA 5

surface-mounted light; steel, black / plastic, white
Aufbauleuchte; Stahl, schwarz / Kunststoff, weiss
luminaire en saillie; acier, noir / plastique, blanc

H 28, Ø 210



17 W 2000lm

99224 FUEVA 5

surface-mounted light; steel, black / plastic, white
Aufbauleuchte; Stahl, schwarz / Kunststoff, weiss
luminaire en saillie; acier, noir / plastique, blanc

H 28, Ø 285



20,5 W 2400lm



9 002759 992224



Ø 160



9 002759 992231



Ø 210



9 002759 992248



Ø 285



900181



900182



900181 FUEVA 5

surface-mounted light; steel, brushed brass / plastic, white
Aufbauleuchte; Stahl, messing-gebürstet / Kunststoff, weiss
luminaire en saillie; acier, laiton brossé / plastique, blanc

H 28, Ø 210



17W



2000lm



9 008606 229567



Ø 210

900182 FUEVA 5

surface-mounted light; steel, brushed brass / plastic, white
Aufbauleuchte; Stahl, messing-gebürstet / Kunststoff, weiss
luminaire en saillie; acier, laiton brossé / plastique, blanc

H 28, Ø 285



20,5W



2400lm



9 008606 229574



Ø 285



900182

LED





99225



99227



99226



99225 FUEVA 5

surface-mounted light; steel, white / plastic, white
Aufbauleuchte; Stahl, weiss / Kunststoff, weiss
luminaire en saillie; acier, blanc / plastique, blanc

H 28, Ø 160



11W 1350lm

99226 FUEVA 5

surface-mounted light; steel, white / plastic, white
Aufbauleuchte; Stahl, weiss / Kunststoff, weiss
luminaire en saillie; acier, blanc / plastique, blanc

H 28, Ø 210



17W 2100lm

99227 FUEVA 5

surface-mounted light; steel, white / plastic, white
Aufbauleuchte; Stahl, weiss / Kunststoff, weiss
luminaire en saillie; acier, blanc / plastique, blanc

H 28, Ø 285



20,5W 2500lm



9 002759 992255

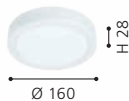

9 002759 992262

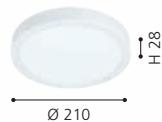

9 002759 992279





99228



99232



99229



99228 FUEVA 5

surface-mounted light; steel, satin nickel / plastic, white
Aufbauleuchte; Stahl, nickel-matt / Kunststoff, weiss
luminaire en saillie; acier, nickel mat / plastique, blanc

H 28, Ø 160



11W

1350lm

99229 FUEVA 5

surface-mounted light; steel, satin nickel / plastic, white
Aufbauleuchte; Stahl, nickel-matt / Kunststoff, weiss
luminaire en saillie; acier, nickel mat / plastique, blanc

H 28, Ø 210



17W

2100lm

99232 FUEVA 5

surface-mounted light; steel, satin nickel / plastic, white
Aufbauleuchte; Stahl, nickel-matt / Kunststoff, weiss
luminaire en saillie; acier, nickel mat / plastique, blanc

H 28, Ø 285



20,5W

2500lm



9 002759 992286

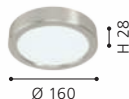

9 002759 992293



9 002759 992323





99233



99235



99234



99233 FUEVA 5

surface-mounted light; steel, black / plastic, white
Aufbauleuchte; Stahl, schwarz / Kunststoff, weiss
luminaire en saillie; acier, noir / plastique, blanc

H 28, Ø 160



11W 1350lm

99234 FUEVA 5

surface-mounted light; steel, black / plastic, white
Aufbauleuchte; Stahl, schwarz / Kunststoff, weiss
luminaire en saillie; acier, noir / plastique, blanc

H 28, Ø 210



17W 2100lm

99235 FUEVA 5

surface-mounted light; steel, black / plastic, white
Aufbauleuchte; Stahl, schwarz / Kunststoff, weiss
luminaire en saillie; acier, noir / plastique, blanc

H 28, Ø 285



20,5W 2500lm



9 002759 992330

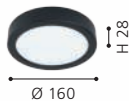

9 002759 992347



9 002759 992354





99235

LED





99236

LED



99238

LED



99237

LED

99236 FUEVA 5

surface-mounted light; steel, white / plastic, white
Aufbauleuchte; Stahl, weiss / Kunststoff, weiss
luminaire en saillie; acier, blanc / plastique, blanc

L 160, B 160, H 28



11W 1350lm

99237 FUEVA 5

surface-mounted light; steel, white / plastic, white
Aufbauleuchte; Stahl, weiss / Kunststoff, weiss
luminaire en saillie; acier, blanc / plastique, blanc

L 210, B 210, H 28



17W 2000lm

99238 FUEVA 5

surface-mounted light; steel, white / plastic, white
Aufbauleuchte; Stahl, weiss / Kunststoff, weiss
luminaire en saillie; acier, blanc / plastique, blanc

L 285, B 285, H 28



20,5W 2400lm



9 002759 992361

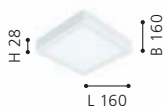

9 002759 992378

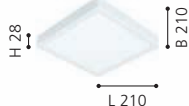

9 002759 992385





99239

LED



99242

LED



99241

LED

99239 FUEVA 5

surface-mounted light; steel, satin nickel / plastic, white
Aufbauleuchte; Stahl, nickel-matt / Kunststoff, weiss
luminaire en saillie; acier, nickel mat / plastique, blanc

L 160, B 160, H 28



11W



1350lm



99241 FUEVA 5

surface-mounted light; steel, satin nickel / plastic, white
Aufbauleuchte; Stahl, nickel-matt / Kunststoff, weiss
luminaire en saillie; acier, nickel mat / plastique, blanc

L 210, B 210, H 28



17W



2000lm



99242 FUEVA 5

surface-mounted light; steel, satin nickel / plastic, white
Aufbauleuchte; Stahl, nickel-matt / Kunststoff, weiss
luminaire en saillie; acier, nickel mat / plastique, blanc

L 285, B 285, H 28



20,5W



2400lm



9 002759 992392



9 002759 992415



9 002759 992422





99243



99245



99244



99243 FUEVA 5

surface-mounted light; steel, black / plastic, white
Aufbauleuchte; Stahl, schwarz / Kunststoff, weiss
luminaire en saillie; acier, noir / plastique, blanc

L 160, B 160, H 28



11W 1350lm

99244 FUEVA 5

surface-mounted light; steel, black / plastic, white
Aufbauleuchte; Stahl, schwarz / Kunststoff, weiss
luminaire en saillie; acier, noir / plastique, blanc

L 210, B 210, H 28



17W 2000lm

99245 FUEVA 5

surface-mounted light; steel, black / plastic, white
Aufbauleuchte; Stahl, schwarz / Kunststoff, weiss
luminaire en saillie; acier, noir / plastique, blanc

L 285, B 285, H 28



20,5W 2400lm



9 002759 992439

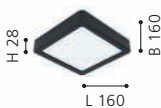

9 002759 992446



9 002759 992453





900183



900184



900183 FUEVA 5

surface-mounted light; steel, brushed brass / plastic, white
Aufbauleuchte; Stahl, messing-gebürstet / Kunststoff, weiss
luminaire en saillie; acier, laiton brossé / plastique, blanc

L 210, B 210, H 28



17W



2000lm



900184 FUEVA 5

surface-mounted light; steel, brushed brass / plastic, white
Aufbauleuchte; Stahl, messing-gebürstet / Kunststoff, weiss
luminaire en saillie; acier, laiton brossé / plastique, blanc

L 285, B 285, H 28



20,5W



2400lm



9 008606 229581

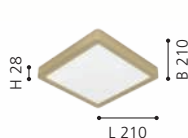

9 008606 229598





99246



99248



99247



99246 FUEVA 5

surface-mounted light; steel, white / plastic, white
Aufbauleuchte; Stahl, weiss / Kunststoff, weiss
luminaire en saillie; acier, blanc / plastique, blanc

L 160, B 160, H 28



11W 1350lm

99247 FUEVA 5

surface-mounted light; steel, white / plastic, white
Aufbauleuchte; Stahl, weiss / Kunststoff, weiss
luminaire en saillie; acier, blanc / plastique, blanc

L 210, B 210, H 28



17W 2100lm

99248 FUEVA 5

surface-mounted light; steel, white / plastic, white
Aufbauleuchte; Stahl, weiss / Kunststoff, weiss
luminaire en saillie; acier, blanc / plastique, blanc

L 285, B 285, H 28



20,5W 2500lm



9 002759 992460

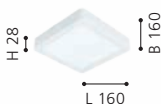

9 002759 992477

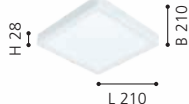

9 002759 992484

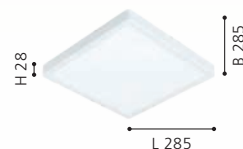



99252

LED



99254

LED



99253

LED

99252 FUEVA 5

surface-mounted light; steel, satin nickel / plastic, white
Aufbauleuchte; Stahl, nickel-matt / Kunststoff, weiss
luminaire en saillie; acier, nickel mat / plastique, blanc

L 160, B 160, H 28



11W 1350lm

99253 FUEVA 5

surface-mounted light; steel, satin nickel / plastic, white
Aufbauleuchte; Stahl, nickel-matt / Kunststoff, weiss
luminaire en saillie; acier, nickel mat / plastique, blanc

L 210, B 210, H 28



17W 2100lm

99254 FUEVA 5

surface-mounted light; steel, satin nickel / plastic, white
Aufbauleuchte; Stahl, nickel-matt / Kunststoff, weiss
luminaire en saillie; acier, nickel mat / plastique, blanc

L 285, B 285, H 28



20,5W 2500lm



9 002759 992521

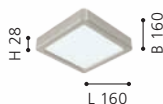

9 002759 992538

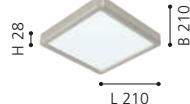

9 002759 992545

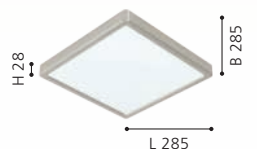



99255



99257



99256



99255 FUEVA 5

surface-mounted light; steel, black / plastic, white
Aufbauleuchte; Stahl, schwarz / Kunststoff, weiss
luminaire en saillie; acier, noir / plastique, blanc

L 160, B 160, H 28



11W 1350lm

99256 FUEVA 5

surface-mounted light; steel, black / plastic, white
Aufbauleuchte; Stahl, schwarz / Kunststoff, weiss
luminaire en saillie; acier, noir / plastique, blanc

L 210, B 210, H 28



17W 2100lm

99257 FUEVA 5

surface-mounted light; steel, black / plastic, white
Aufbauleuchte; Stahl, schwarz / Kunststoff, weiss
luminaire en saillie; acier, noir / plastique, blanc

L 285, B 285, H 28



20,5W 2500lm



9 002759 992552



9 002759 992569



9 002759 992576





99256

LED



99258



900582



99259



900582 FUEVA 5

surface-mounted light; steel, white / plastic, white
Aufbauleuchte; Stahl, weiss / Kunststoff, weiss
luminaire en saillie; acier, blanc / plastique, blanc

H 28, Ø 160

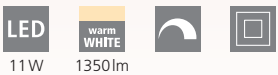

11W 1350lm

99258 FUEVA 5

surface-mounted light; steel, white / plastic, white
Aufbauleuchte; Stahl, weiss / Kunststoff, weiss
luminaire en saillie; acier, blanc / plastique, blanc

H 28, Ø 210



17W 2000lm

99259 FUEVA 5

surface-mounted light; steel, white / plastic, white
Aufbauleuchte; Stahl, weiss / Kunststoff, weiss
luminaire en saillie; acier, blanc / plastique, blanc

H 28, Ø 285



20,5W 2400lm



9 008606 244829

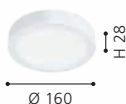

9 002759 992583



9 002759 992590





900583



900584



900585



900583 FUEVA 5

surface-mounted light; steel, satin nickel / plastic, white
Aufbauleuchte; Stahl, nickel-matt / Kunststoff, weiss
luminaire en saillie; acier, nickel mat / plastique, blanc

H 28, Ø 160



11W



1350lm



900584 FUEVA 5

surface-mounted light; steel, satin nickel / plastic, white
Aufbauleuchte; Stahl, nickel-matt / Kunststoff, weiss
luminaire en saillie; acier, nickel mat / plastique, blanc

H 28, Ø 210



17W



2000lm



900585 FUEVA 5

surface-mounted light; steel, satin nickel / plastic, white
Aufbauleuchte; Stahl, nickel-matt / Kunststoff, weiss
luminaire en saillie; acier, nickel mat / plastique, blanc

H 28, Ø 285



20,5W



2400lm



9 008606 244836



Ø 160



9 008606 244843



Ø 210



9 008606 244850



Ø 285



900581



99263



99264



900581 FUEVA 5

surface-mounted light; steel, black / plastic, white
Aufbauleuchte; Stahl, schwarz / Kunststoff, weiss
luminaire en saillie; acier, noir / plastique, blanc

H 28, Ø 160



11W 1350lm

99263 FUEVA 5

surface-mounted light; steel, black / plastic, white
Aufbauleuchte; Stahl, schwarz / Kunststoff, weiss
luminaire en saillie; acier, noir / plastique, blanc

H 28, Ø 210



17W 2000lm

99264 FUEVA 5

surface-mounted light; steel, black / plastic, white
Aufbauleuchte; Stahl, schwarz / Kunststoff, weiss
luminaire en saillie; acier, noir / plastique, blanc

H 28, Ø 285



20,5W 2400lm



9 008606 244812

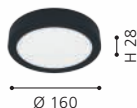

9 002759 992637



9 002759 992644





900589



900592



900591



900589 FUEVA 5

surface-mounted light; steel, white / plastic, white
Aufbauleuchte; Stahl, weiss / Kunststoff, weiss
luminaire en saillie; acier, blanc / plastique, blanc

L 160, B 160, H 28



11W 1350lm

900591 FUEVA 5

surface-mounted light; steel, white / plastic, white
Aufbauleuchte; Stahl, weiss / Kunststoff, weiss
luminaire en saillie; acier, blanc / plastique, blanc

L 210, B 210, H 28



17W 2000lm

900592 FUEVA 5

surface-mounted light; steel, white / plastic, white
Aufbauleuchte; Stahl, weiss / Kunststoff, weiss
luminaire en saillie; acier, blanc / plastique, blanc

L 285, B 285, H 28



20,5W 2400lm



9 008606 244898

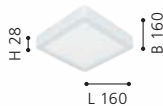

9 008606 244904

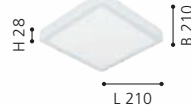

9 008606 244911

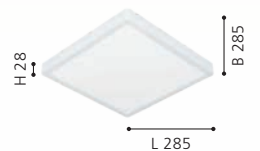



900593



900595



900594



900593 FUEVA 5

surface-mounted light; steel, satin nickel / plastic, white
Aufbauleuchte; Stahl, nickel-matt / Kunststoff, weiss
luminaire en saillie; acier, nickel mat / plastique, blanc

L 160, B 160, H 28



11W 1350lm

900594 FUEVA 5

surface-mounted light; steel, satin nickel / plastic, white
Aufbauleuchte; Stahl, nickel-matt / Kunststoff, weiss
luminaire en saillie; acier, nickel mat / plastique, blanc

L 210, B 210, H 28



17W 2000lm

900595 FUEVA 5

surface-mounted light; steel, satin nickel / plastic, white
Aufbauleuchte; Stahl, nickel-matt / Kunststoff, weiss
luminaire en saillie; acier, nickel mat / plastique, blanc

L 285, B 285, H 28



20,5W 2400lm



9 008606 244928

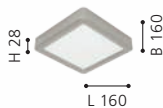

9 008606 244935

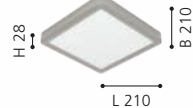

9 008606 244942





900586

LED

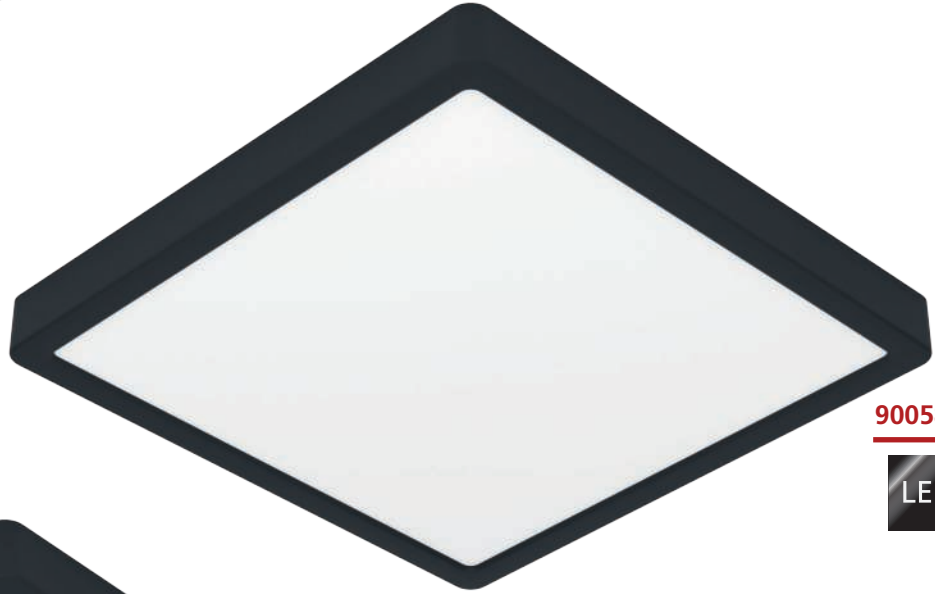

900588

LED



900587

LED



900586 FUEVA 5

surface-mounted light; steel, black / plastic, white
Aufbauleuchte; Stahl, schwarz / Kunststoff, weiss
luminaire en saillie; acier, noir / plastique, blanc

L 160, B 160, H 28

LED

11W

warm
WHITE

1350lm



900587 FUEVA 5

surface-mounted light; steel, black / plastic, white
Aufbauleuchte; Stahl, schwarz / Kunststoff, weiss
luminaire en saillie; acier, noir / plastique, blanc

L 210, B 210, H 28

LED

17W

warm
WHITE

2000lm



900588 FUEVA 5

surface-mounted light; steel, black / plastic, white
Aufbauleuchte; Stahl, schwarz / Kunststoff, weiss
luminaire en saillie; acier, noir / plastique, blanc

L 285, B 285, H 28

LED

20,5W

warm
WHITE

2400lm



9 008606 244867

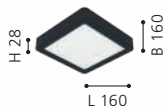

L 160



9 008606 244874



L 210



9 008606 244881



L 285



900638



IP44



900654



IP44



99265



IP44

900638 FUEVA 5

surface-mounted light; steel, white / plastic, white
Aufbauleuchte; Stahl, weiss / Kunststoff, weiss
luminaire en saillie; acier, blanc / plastique, blanc

H 28, Ø 160



11W 1350lm

900654 FUEVA 5

surface-mounted light; steel, white / plastic, white
Aufbauleuchte; Stahl, weiss / Kunststoff, weiss
luminaire en saillie; acier, blanc / plastique, blanc

H 28, Ø 210



17W 2000lm

99265 FUEVA 5

surface-mounted light; steel, white / plastic, white
Aufbauleuchte; Stahl, weiss / Kunststoff, weiss
luminaire en saillie; acier, blanc / plastique, blanc

H 28, Ø 285



20,5W 2400lm



9 008606 245222

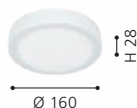

9 008606 245369



9 002759 992651





900639



IP44



900641



IP44



99266



IP44

900639 FUEVA 5

surface-mounted light; steel, chrome / plastic, white
 Aufbauleuchte; Stahl, chrom / Kunststoff, weiss
 luminaire en saillie; acier, chrome / plastique, blanc

H 28, Ø 160



900641 FUEVA 5

surface-mounted light; steel, chrome / plastic, white
 Aufbauleuchte; Stahl, chrom / Kunststoff, weiss
 luminaire en saillie; acier, chrome / plastique, blanc

H 28, Ø 210



99266 FUEVA 5

surface-mounted light; steel, chrome / plastic, white
 Aufbauleuchte; Stahl, chrom / Kunststoff, weiss
 luminaire en saillie; acier, chrome / plastique, blanc

H 28, Ø 285



9 008606 245239



Ø 160



9 008606 245246



Ø 210



9 002759 992668



Ø 285



900637



IP44



900653



IP44



99267



IP44

900637 FUEVA 5

surface-mounted light; steel, black / plastic, white
Aufbauleuchte; Stahl, schwarz / Kunststoff, weiss
luminaire en saillie; acier, noir / plastique, blanc

H 28, Ø 160



11W 1350lm

900653 FUEVA 5

surface-mounted light; steel, black / plastic, white
Aufbauleuchte; Stahl, schwarz / Kunststoff, weiss
luminaire en saillie; acier, noir / plastique, blanc

H 28, Ø 210



17W 2000lm

99267 FUEVA 5

surface-mounted light; steel, black / plastic, white
Aufbauleuchte; Stahl, schwarz / Kunststoff, weiss
luminaire en saillie; acier, noir / plastique, blanc

H 28, Ø 285



20,5W 2400lm



9 008606 245215

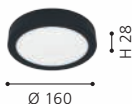

9 008606 245352



9 002759 992675





99267

LED



IP44





900646



IP44



99268



IP44



900647



IP44

900646 FUEVA 5

surface-mounted light; steel, white / plastic, white
Aufbauleuchte; Stahl, weiss / Kunststoff, weiss
luminaire en saillie; acier, blanc / plastique, blanc

L 160, B 160, H 28



11W



1350lm



IP44



900647 FUEVA 5

surface-mounted light; steel, white / plastic, white
Aufbauleuchte; Stahl, weiss / Kunststoff, weiss
luminaire en saillie; acier, blanc / plastique, blanc

L 210, B 210, H 28



17W



2000lm



IP44



99268 FUEVA 5

surface-mounted light; steel, white / plastic, white
Aufbauleuchte; Stahl, weiss / Kunststoff, weiss
luminaire en saillie; acier, blanc / plastique, blanc

L 285, B 285, H 30



20,5W



2400lm



IP44



9 008606 245291



L 160



9 008606 245307



L 210



9 002759 992682



L 285



900649



IP44



99269



IP44



900651



IP44

900649 FUEVA 5

surface-mounted light; steel, chrome / plastic, white
Aufbauleuchte; Stahl, chrom / Kunststoff, weiss
luminaire en saillie; acier, chrome / plastique, blanc

L 160, B 160, H 28



11 W



1350 lm



IP44



900651 FUEVA 5

surface-mounted light; steel, chrome / plastic, white
Aufbauleuchte; Stahl, chrom / Kunststoff, weiss
luminaire en saillie; acier, chrome / plastique, blanc

L 210, B 210, H 28



17 W



2000 lm



IP44



99269 FUEVA 5

surface-mounted light; steel, chrome / plastic, white
Aufbauleuchte; Stahl, chrom / Kunststoff, weiss
luminaire en saillie; acier, chrome / plastique, blanc

L 285, B 285, H 30



20,5 W



2400 lm



IP44



9 008606 245321



L 160



9 008606 245338



L 210



9 002759 992699



L 285



900643



IP44



99271



IP44



900644



IP44

900643 FUEVA 5

surface-mounted light; steel, black / plastic, white
Aufbauleuchte; Stahl, schwarz / Kunststoff, weiss
luminaire en saillie; acier, noir / plastique, blanc

L 160, B 160, H 28



11W



1350lm



IP44



900644 FUEVA 5

surface-mounted light; steel, black / plastic, white
Aufbauleuchte; Stahl, schwarz / Kunststoff, weiss
luminaire en saillie; acier, noir / plastique, blanc

L 210, B 210, H 28



17W



2000lm



IP44



99271 FUEVA 5

surface-mounted light; steel, black / plastic, white
Aufbauleuchte; Stahl, schwarz / Kunststoff, weiss
luminaire en saillie; acier, noir / plastique, blanc

L 285, B 285, H 30



20,5W



2400lm



IP44



9 008606 245260

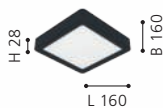

9 008606 245277



9 002759 992712





900644

LED



IP44





30892

LED



IP44



30892

LED



IP44



30891

LED



IP44

30892 FUEVA 5

surface-mounted light; steel, chrome / plastic, white
Aufbauleuchte; Stahl, chrom / Kunststoff, weiss
luminaire en saillie; acier, chrome / plastique, blanc

H 28, Ø 285

LED

20,5W

neutral
WHITE

2500lm



IP44





30894



IP44



30893



IP44

30891 FUEVA 5

surface-mounted light; steel, white / plastic, white
 Aufbauleuchte; Stahl, weiss / Kunststoff, weiss
 luminaire en saillie; acier, blanc / plastique, blanc

H 28, Ø 285



30894 FUEVA 5

surface-mounted light; steel, chrome / plastic, white
 Aufbauleuchte; Stahl, chrom / Kunststoff, weiss
 luminaire en saillie; acier, chrome / plastique, blanc

L 285, B 285, H 30



30893 FUEVA 5

surface-mounted light; steel, white / plastic, white
 Aufbauleuchte; Stahl, weiss / Kunststoff, weiss
 luminaire en saillie; acier, blanc / plastique, blanc

L 285, B 285, H 30



9 002759 308919



9 002759 308940



9 002759 308933





97262



97279



97271



97262 FUEVA 1

surface-mounted light; aluminium, white / plastic, white
Aufbauleuchte; Alu, weiss / Kunststoff, weiss
luminaire en saillie; aluminium, blanc / plastique, blanc

H 30, Ø 400



22,3W 2500lm

97271 FUEVA 1

surface-mounted light; aluminium, white / plastic, white
Aufbauleuchte; Alu, weiss / Kunststoff, weiss
luminaire en saillie; aluminium, blanc / plastique, blanc

H 30, Ø 500



26W 3000lm

97279 FUEVA 1

surface-mounted light; aluminium, white / plastic, white
Aufbauleuchte; Alu, weiss / Kunststoff, weiss
luminaire en saillie; aluminium, blanc / plastique, blanc

H 30, Ø 600



27W 3400lm



9 002759 972622



9 002759 972714



9 002759 972790





97263



97266



97267



97266 FUEVA 1

surface-mounted light; aluminium, white / plastic, white
Aufbauleuchte; Alu, weiss / Kunststoff, weiss
luminaire en saillie; aluminium, blanc / plastique, blanc

H 30, Ø 400



22,3W 2600lm

97263 FUEVA 1

surface-mounted light; aluminium, silver / plastic, white
Aufbauleuchte; Alu, silber / Kunststoff, weiss
luminaire en saillie; aluminium, argent / plastique, blanc

H 30, Ø 400



22,3W 2500lm

97267 FUEVA 1

surface-mounted light; aluminium, silver / plastic, white
Aufbauleuchte; Alu, silber / Kunststoff, weiss
luminaire en saillie; aluminium, argent / plastique, blanc

H 30, Ø 400



22,3W 2600lm



9 002759 972660



9 002759 972639

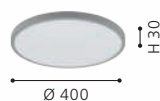

9 002759 972677

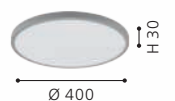



97269

LED



97265

LED

97265 FUEVA 1

surface-mounted light; aluminium, silver / plastic, white
 Aufbauleuchte; Alu, silber / Kunststoff, weiss
 luminaire en saillie; aluminium, argent / plastique, blanc

L 400, B 400, H 30



97269 FUEVA 1

surface-mounted light; aluminium, silver / plastic, white
 Aufbauleuchte; Alu, silber / Kunststoff, weiss
 luminaire en saillie; aluminium, argent / plastique, blanc

L 400, B 400, H 30



97264 FUEVA 1

surface-mounted light; aluminium, white / plastic, white
 Aufbauleuchte; Alu, weiss / Kunststoff, weiss
 luminaire en saillie; aluminium, blanc / plastique, blanc

L 400, B 400, H 30

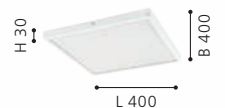
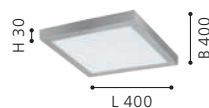
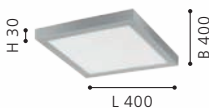



97268

LED

97264

LED



97268

LED

97268 FUEVA 1

surface-mounted light; aluminium, white / plastic, white
Aufbauleuchte; Alu, weiss / Kunststoff, weiss
luminaire en saillie; aluminium, blanc / plastique, blanc

L 400, B 400, H 30

LED

22W

neutral
WHITE

2600lm



9 002759 972684

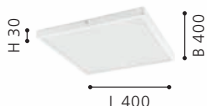

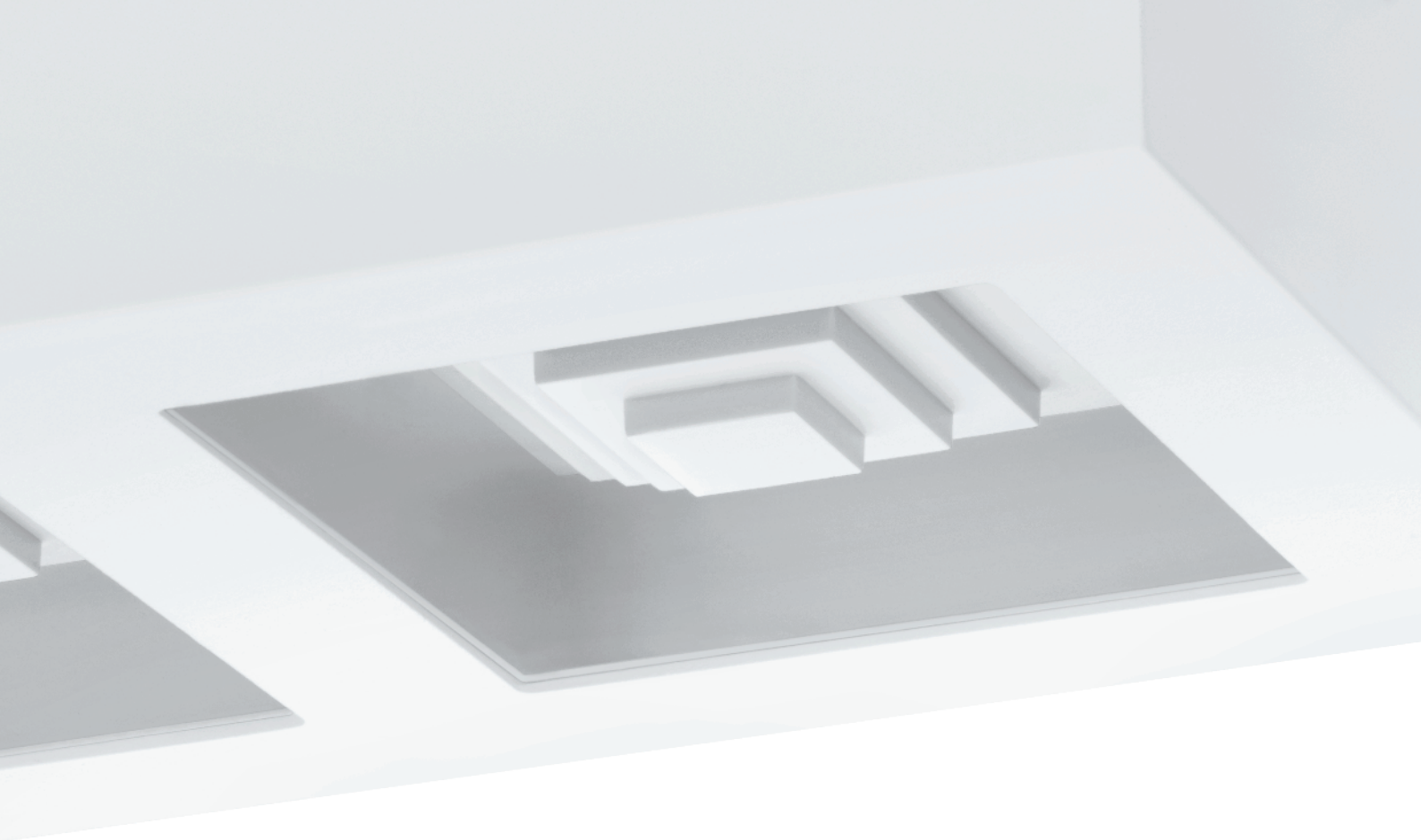

SURFACE DOWNLIGHTS

DECORATIVE

ADVANTAGES

- > UNIFORM DISTRIBUTION OF INDIRECT LIGHT - IDEAL FOR ILLUMINATING SPACES AND SURFACES
 - > LOW TEMPERATURE ENHANCES SAFETY
 - > UP TO 80% POWER SAVINGS COMPARED TO INCANDESCENT LAMPS, EASY ON YOUR BUDGET AND THE ENVIRONMENT
-

VORTEILE

- > HOMOGENES, INDIREKTES LICHT – IDEAL ZUR BELEUCHTUNG VON RÄUMEN UND FLÄCHEN
 - > GERINGE WÄRMEENTWICKLUNG SORGT FÜR MEHR SICHERHEIT
 - > BIS ZU 80% STROMERSPARNIS GEGENÜBER GLÜHLAMPEN, SCHONT IHR BUDGET UND DIE UMWELT
-

AVANTAGES

- > LA DISTRIBUTION UNIFORME DE LA LUMIÈRE INDIRECTE - IDÉAL POUR LES ESPACES ET LES SURFACES ÉCLAIRANTES
- > FAIBLE CHALEUR AMÉLIORE LA SÉCURITÉ
- > JUSQU'À 80% D'ÉCONOMIES D'ÉNERGIE PAR RAPPORT AUX LAMPES À INCANDESCENCE, RÉDUIT VOTRE BUDGET ET PROTÈGE L'ENVIRONNEMENT

OVERVIEW



CRESPILLO
p. 274 - 275



POLASSO
p. 276 - 278

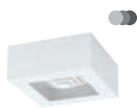

FERREROS
p. 280



GRIMASOLA
p. 282 - 283



This product is available in different colors and shapes./ Dieser Artikel ist in unterschiedlichen Farben und Formen verfügbar.
Cet article est disponible en différentes couleurs et formes.



99338

LED



99337

LED



99726

LED

99337 CRESPILLO

surface-mounted light; plastic, steel, white / plastic, white
Aufbauleuchte; Kunststoff, Stahl, weiss / Kunststoff, weiss
luminaire en saillie; plastique, acier, blanc / plastique, blanc

H 45, Ø 240



12,5W 1350lm

99338 CRESPILLO

surface-mounted light; plastic, steel, white / plastic, white
Aufbauleuchte; Kunststoff, Stahl, weiss / Kunststoff, weiss
luminaire en saillie; plastique, acier, blanc / plastique, blanc

H 45, Ø 315



15W 1800lm

99726 CRESPILLO

surface-mounted light; plastic, white / plastic, white
Aufbauleuchte; Kunststoff, weiss / Kunststoff, weiss
luminaire en saillie; plastique, blanc / plastique, blanc

H 65, Ø 380



21W 3000lm



9 002759 993375

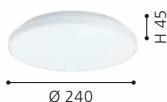

9 002759 993382



9 002759 997267

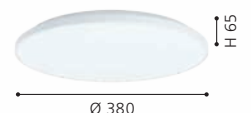



99727

LED



99338

LED

99727 CRESPILLO

surface-mounted light; plastic, white / plastic, white
Aufbauleuchte; Kunststoff, weiss / Kunststoff, weiss
luminaire en saillie; plastique, blanc / plastique, blanc

H 65, Ø 500

LED

29W

neutral
WHITE

4800lm



9 002759 997274



H 65

Ø 500





94501

LED



94502

LED



94504

LED

94501 POLASSO

ceiling light; aluminium, plastic, black, copper
Deckenleuchte; Alu, Kunststoff, schwarz, kupfer
plafonnier; aluminium, plastique, noir, cuivre

H 120, Ø 100



1x 3,3W 340lm



9 002759 945015



94504 POLASSO

ceiling light; aluminium, plastic, white, silver
Deckenleuchte; Alu, Kunststoff, weiss, silber
plafonnier; aluminium, plastique, blanc, argent

H 120, Ø 100



1x 3,3W 340lm



9 002759 945046



94502 POLASSO

ceiling light; aluminium, plastic, black, gold
Deckenleuchte; Alu, Kunststoff, schwarz, gold
plafonnier; aluminium, plastique, noir, or

H 120, Ø 100



1x 3,3W 340lm



9 002759 945022





94503

LED



94501

LED

94503 POLASSO

ceiling light; aluminium, plastic, white, gold
Deckenleuchte; Alu, Kunststoff, weiss, gold
plafonnier; aluminium, plastique, blanc, or

H 120, Ø 100

LED

warm
WHITE



1x 3,3W 340lm



9 002759 945039



H 120

Ø 100

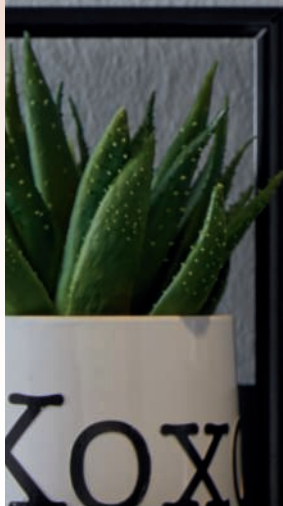



94496

LED



94499

LED



94497

LED

94496 POLASSO

ceiling light; aluminium, plastic, black, copper
Deckenleuchte; Alu, Kunststoff, schwarz, kupfer
plafonnier; aluminium, plastique, noir, cuivre

L 100, B 100, H 120

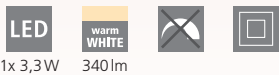

1x 3,3W 340lm



9 002759 944964

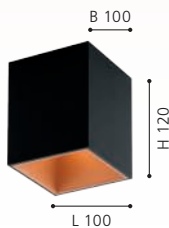

94497 POLASSO

ceiling light; aluminium, plastic, black, gold
Deckenleuchte; Alu, Kunststoff, schwarz, gold
plafonnier; aluminium, plastique, noir, or

L 100, B 100, H 120



1x 3,3W 340lm



9 002759 944971

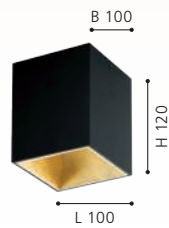

94499 POLASSO

ceiling light; aluminium, plastic, white, silver
Deckenleuchte; Alu, Kunststoff, weiss, silber
plafonnier; aluminium, plastique, blanc, argent

L 100, B 100, H 120



1x 3,3W 340lm



9 002759 944995

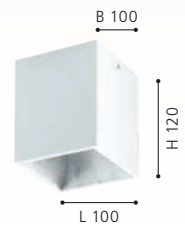



94497

LED



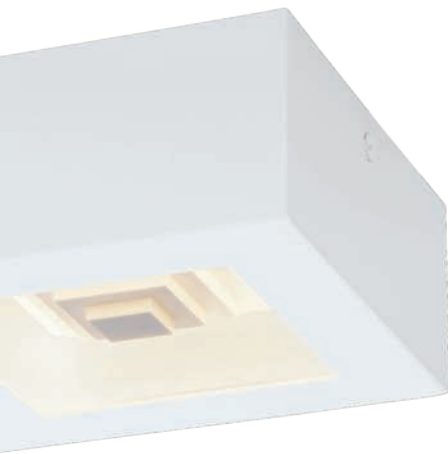

FERREROS

These luminaires have a special leveling effect.

Diese Leuchten besitzen einen besonderen Stufeneffekt.

Ces luminaires ont un effet escalier spécial.



96791

LED

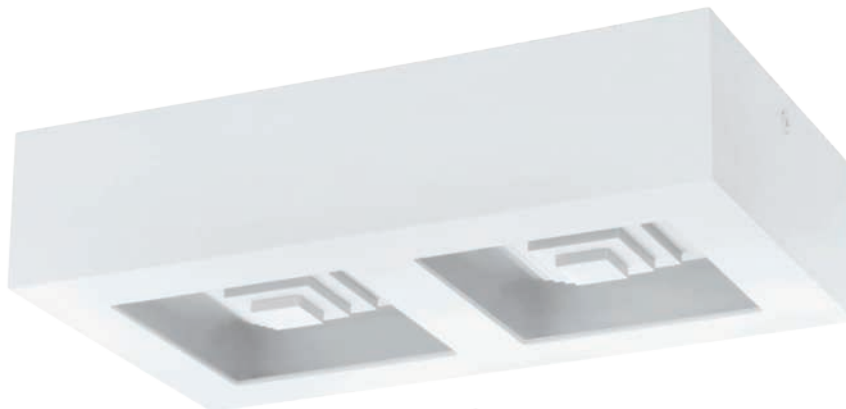

96792

LED

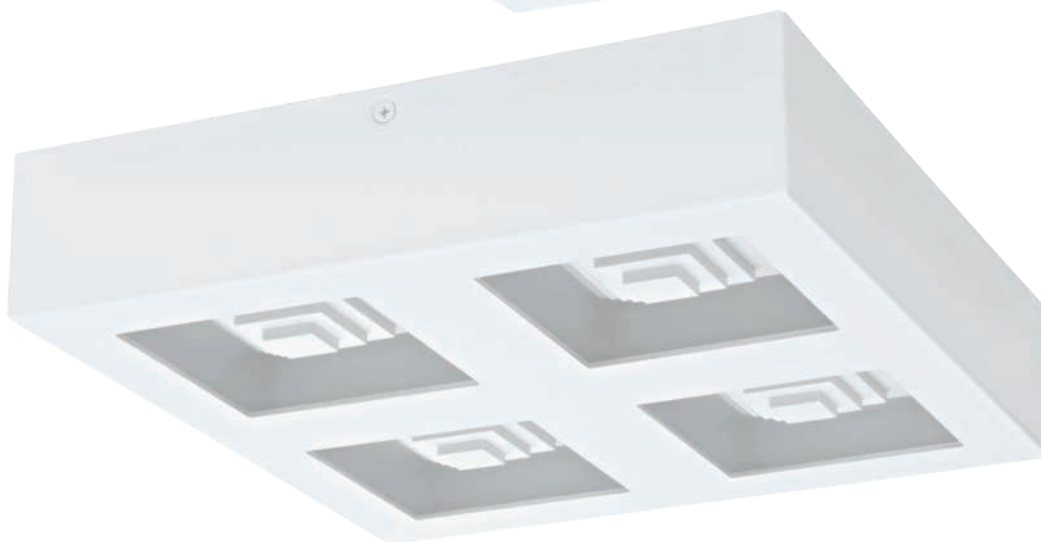

96794

LED

96791 FERREROS

wall / ceiling light; steel, white / plastic, white
Wand- / Deckenleuchte; Stahl, weiss / Kunststoff, weiss
applique / plafonnier; acier, blanc / plastique, blanc

L 140, B 140, H 60



1x 6,3W 840lm

96792 FERREROS

wall / ceiling light; steel, white / plastic, white
Wand- / Deckenleuchte; Stahl, weiss / Kunststoff, weiss
applique / plafonnier; acier, blanc / plastique, blanc

L 255, B 140, H 60



2x 6,3W 1680lm

96794 FERREROS

wall / ceiling light; steel, white / plastic, white
Wand- / Deckenleuchte; Stahl, weiss / Kunststoff, weiss
applique / plafonnier; acier, blanc / plastique, blanc

L 270, B 270, H 60



4x 6,3W 3360lm



9 002759 967918

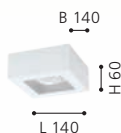

9 002759 967925

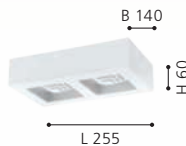

9 002759 967949

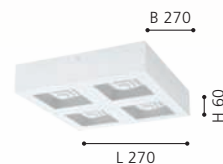

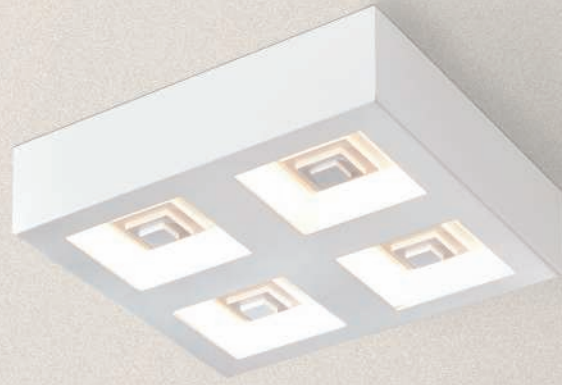

96794

LED





99281



99282

99282 GRIMASOLA

surface-mounted light; aluminium, steel, white / plastic, white
Aufbauleuchte; Alu, Stahl, weiss / Kunststoff, weiss
luminaire en saillie; aluminium, acier, blanc / plastique, blanc

L 240, B 140, H 110



E27



2x 25 W

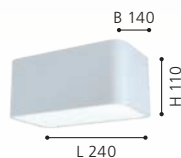

99281 GRIMASOLA

surface-mounted light; aluminium, steel, white / plastic, white
Aufbauleuchte; Alu, Stahl, weiss / Kunststoff, weiss
luminaire en saillie; aluminium, acier, blanc / plastique, blanc

L 140, B 140, H 110



E27



1x 25 W

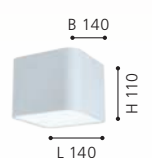



99283



99284

99284 GRIMASOLA

surface-mounted light; aluminium, steel, black / plastic, white
Aufbauleuchte; Alu, Stahl, schwarz / Kunststoff, weiss
luminaire en saillie; aluminium, acier, noir / plastique, blanc

L 240, B 140, H 110



E27



2x 25W

99283 GRIMASOLA

surface-mounted light; aluminium, steel, black / plastic, white
Aufbauleuchte; Alu, Stahl, schwarz / Kunststoff, weiss
luminaire en saillie; aluminium, acier, noir / plastique, blanc

L 140, B 140, H 110



E27



1x 25W



9 002759 992842

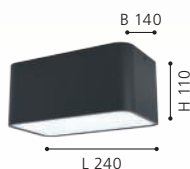

9 002759 992835

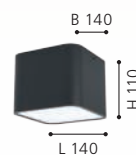



LED STRIPE SOLUTIONS

STRIPES & PROFILES

ADVANTAGES

- > UNLIMITED POSSIBILITIES, FREE SCOPE FOR DESIGN
- > DIFFERENT LIGHT TEMPERATURES: WARM WHITE/NEUTRAL WHITE AND FUNCTIONS LIKE: RGB, MOTION SENSOR
- > BASIC, FLEX AND PREMIUM COB
- > ALL STRIPS ARE FITTED WITH SELF-ADHESIVE BACKING
- > FREE MOUNTING OR MOUNTING IN LED PROFILE
- > ALL STRIPS CAN BE CUT ONCE

VORTEILE

- > UNENDLICHE MÖGLICHKEITEN, FREI PLANBAR
- > VERSCHIEDENE LICHTTEMPERATUREN: WARMWHITE/NEUTRAL WHITE UND FUNKTIONEN WIE RGB, MOTION SENSOR
- > BASIC, FLEX UND PREMIUM COB
- > ALLE STREIFEN MIT SELBSTKLEBENDER RÜCKSEITE
- > MONTAGE FREI ODER IN LED PROFIL
- > ALLE STREIFEN EINMALIG KÜRZBAR

AVANTAGES

- > DES POSSIBILITÉS INFINIES ET UNE LIBERTÉ D'AMÉNAGEMENT
- > DES TEMPÉRATURES D'ÉCLAIRAGE DIVERSES: BLANC CHAUD/BLANC NEUTRE ET FONCTIONS TELS QUE RGB, MOTION SENSOR
- > COB BASIC, FLEX ET PREMIUM
- > TOUS LES RUBANS SONT DOTÉS D'UNE FACE AUTOCOLLANTE
- > MONTAGE AVEC OU SANS PROFIL LED
- > TOUS LES RUBANS SONT DÉCOUPABLES UNE FOIS



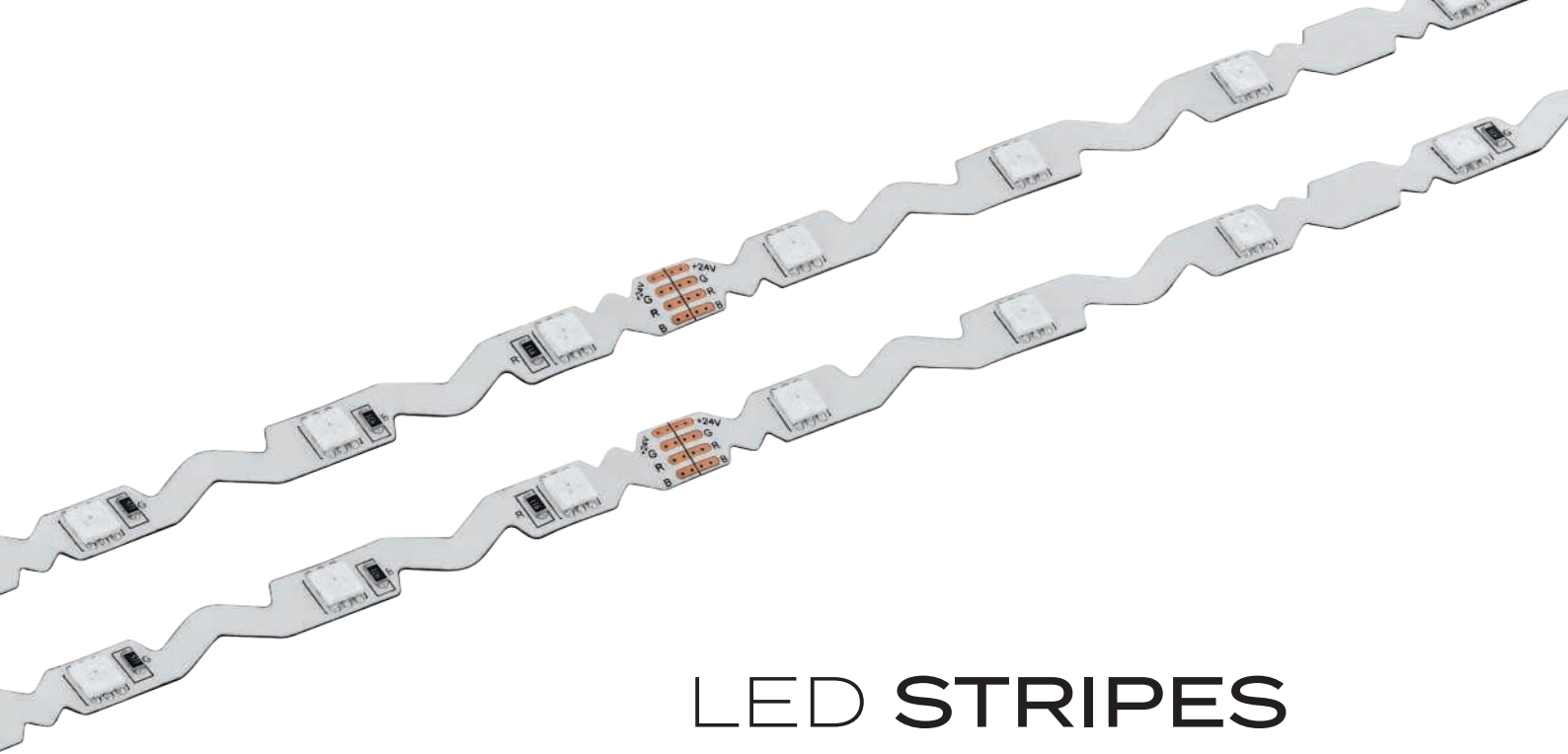

LED STRIPES

ADVANTAGES

- > SLIM DESIGN WITH MINIMAL INSTALLATION DEPTH, MAKING IT IDEAL FOR CEILING STRUCTURES WITH LITTLE SPACE
- > UNIFORM DISTRIBUTION OF LIGHT - IDEAL FOR ILLUMINATING SPACES AND SURFACES
- > LOW TEMPERATURE ENHANCES SAFETY
- > UP TO 80% POWER SAVINGS COMPARED TO INCANDESCENT LAMPS, EASY ON YOUR BUDGET AND THE ENVIRONMENT
- > SIMPLE CABLING THROUGH INTEGRATED TERMINAL CONNECTOR ON DRIVER

VORTEILE

- > SCHLANKE BAUFORM MIT MINIMALER EINBAUTIEFE, DAHER IDEAL FÜR DECKEN-KONSTRUKTIONEN MIT WENIG PLATZ
- > HOMOGENE LICHTVERTEILUNG - IDEAL ZUR BELEUCHTUNG VON RÄUMEN UND FLÄCHEN
- > GERINGE WÄRMEENTWICKLUNG SORGT FÜR MEHR SICHERHEIT
- > BIS ZU 80% STROMERSPARNIS GEGENÜBER GLÜHLAMPEN, SCHONT IHR BUDGET UND DIE UMWELT
- > EINFACHE VERKABELUNG DURCH INTEGRIERTEN KLEMMANSCHLUSS AM TREIBER

AVANTAGES

- > CONCEPTION MINCE AVEC LA PROFONDEUR D'INSTALLATION MINIMALE, IDÉAL POUR LES STRUCTURES DE PLAFOND AVEC PEU D'ESPACE
- > DISTRIBUTION UNIFORME DE LA LUMIÈRE - IDÉAL POUR L'ILLUMINATION DES ESPACES ET SURFACES
- > JUSQU'À 80% D'ÉCONOMIES D'ÉNERGIE PAR RAPPORT AUX LAMPES À INCANDESCENCE, RÉDUIT VOTRE BUDGET ET PROTÈGE L'ENVIRONNEMENT BUDGET AND THE ENVIRONMENT
- > CÂBLAGE SIMPLE VIA LE CONNECTEUR DE TERMINAL INTÉGRÉ SUR CONDUCTEUR

OVERVIEW



COB Stripe
p. 288 - 289



FLEXIBLE STRIPE
p. 290 - 294



LED STRIPES-FLEX
p. 294



PIDIO
p. 295



This product is available in different colors and shapes./ Dieser Artikel ist in unterschiedlichen Farben und Formen verfügbar.
Cet article est disponible en différentes couleurs et formes.



LED STRIPES

COB STRIPES

ADVANTAGES

- > PREMIUM LED STRIPS WITHOUT VISIBLE LIGHT POINTS
- > HOMOGENEOUS LIGHT EMISSION ALONG THE ENTIRE LENGTH
- > 480 LEDS/METRE
- > LATEST CHIP ON BOARD (COB) TECHNOLOGY

VORTEILE

- > PREMIUM LED-STREIFEN OHNE SICHTBARE LICHTPUNKTE
- > HOMOGENE LICHTABSTRAHLUNG ÜBER DIE GESAMTE LÄNGE
- > 480 LEDS / METER
- > NEUESTE CHIP ON BOARD (COB) TECHNOLOGIE

AVANTAGES

- > BANDE LED PREMIUM SANS POINTS LUMINEUX VISIBLES
- > ÉMISSION DE LUMIÈRE HOMOGENÈNE SUR TOUTE LA LONGUEUR
- > 480 LED/MÈTRE
- > DERNIÈRE TECHNOLOGIE CHIP ON BOARD (COB)

900574 COB STRIPE

bar / strip light; plastic, white
Leuchtband/-stab; Kunststoff, weiss
bande lumineuse / bâton l; plastique, blanc

L 2000



LED 12W warm WHITE 800lm



9 008606 244751



L 2000

900575 COB STRIPE

bar / strip light; plastic, white
Leuchtband/-stab; Kunststoff, weiss
bande lumineuse / bâton l; plastique, blanc

L 5000



LED 24W warm WHITE 2000lm



9 008606 244768



L 5000

900576 COB STRIPE

bar / strip light; plastic, white
Leuchtband/-stab; Kunststoff, weiss
bande lumineuse / bâton l; plastique, blanc

L 8000



LED 36W warm WHITE 3200lm



9 008606 244775



L 8000

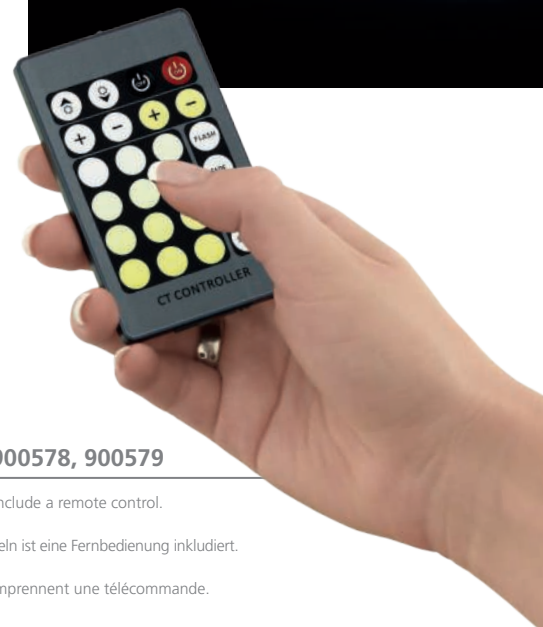

900574



900575



900576



900577



900578



900579



900577, 900578, 900579

These articles include a remote control.

Bei diesen Artikeln ist eine Fernbedienung inkludiert.

Ces articles comprennent une télécommande.

900577 COB STRIPE

bar / strip light; plastic, white
Leuchtband/-stab; Kunststoff, weiss
bande lumineuse / bâton l; plastique, blanc

L 2000



12W



1200lm



remote



900578 COB STRIPE

bar / strip light; plastic, white
Leuchtband/-stab; Kunststoff, weiss
bande lumineuse / bâton l; plastique, blanc

L 5000



24W



2400lm



remote



900579 COB STRIPE

bar / strip light; plastic, white
Leuchtband/-stab; Kunststoff, weiss
bande lumineuse / bâton l; plastique, blanc

L 8000



36W



3600lm



remote



9 008606 244782



L 2000



9 008606 244799



L 5000



9 008606 244805



L 8000

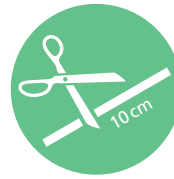

LED STRIPES

FLEXIBLE STRIPES

ADVANTAGES

- > FREELY FORMABLE
- > SELF-ADHESIVE
- > SEPARABLE EVERY 10 CM
- > OPTIMAL ILLUMINATION EVEN IN CORNERS
- > NO SOLDERING OR INTERMEDIATE PIECE NECESSARY

VORTEILE

- > FREI FORMBAR
- > SELBSTKLEBEND
- > ALLE 10 CM KÜRZBAR
- > OPTIMALE AUSLEUCHTUNG AUCH IN ECKEN
- > KEIN LÖTEN ODER ZWISCHENSTÜCK NOTWENDIG

AVANTAGES

- > SE DÉFORME AISÉMENT
- > AUTO-ADHÉSIF
- > PEUT ÊTRE SECTIONNÉ TOUS LES 10 CM
- > UN ÉCLAIRAGE OPTIMAL, MÊME DANS LES COINS
- > PAS DE SOUDURE OU DE PIÈCE INTERMÉDIAIRE NÉCESSAIRE

98571 FLEXIBLE STRIPE

bar / strip light; plastic, white
 Leuchtband/-stab; Kunststoff, weiss
 bande lumineuse / bâton l; plastique, blanc

L 2000, B 6



10,8W 1200lm



9 002759 985714

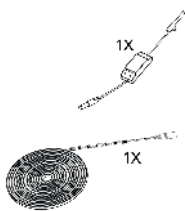

L 2000

98572 FLEXIBLE STRIPE

bar / strip light; plastic, white
 Leuchtband/-stab; Kunststoff, weiss
 bande lumineuse / bâton l; plastique, blanc

L 5000, B 6



27W 3000lm



9 002759 985721

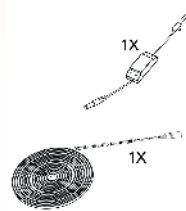

L 5000

99716 FLEXIBLE STRIPE

bar / strip light; white
 Leuchtband/-stab; weiss
 bande lumineuse / bâton l; blanc

L 8000, B 6



8x 5,4W 4960lm



9 002759 997168

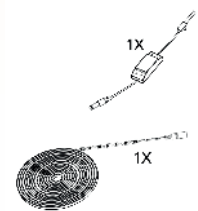

L 8000



99717 FLEXIBLE STRIPE

bar / strip light; white
Leuchtband/-stab; weiss
bande lumineuse / bâton l; blanc

L 2000, B 6

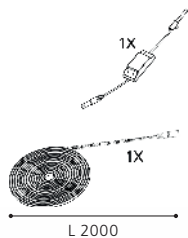

99718 FLEXIBLE STRIPE

bar / strip light; white
Leuchtband/-stab; weiss
bande lumineuse / bâton l; blanc

L 5000, B 6

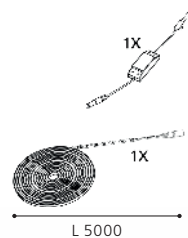

99719 FLEXIBLE STRIPE

bar / strip light; white
Leuchtband/-stab; weiss
bande lumineuse / bâton l; blanc

L 8000, B 8

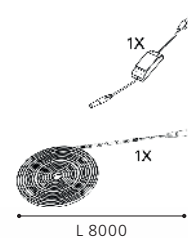

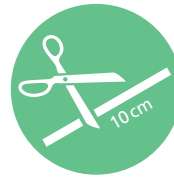
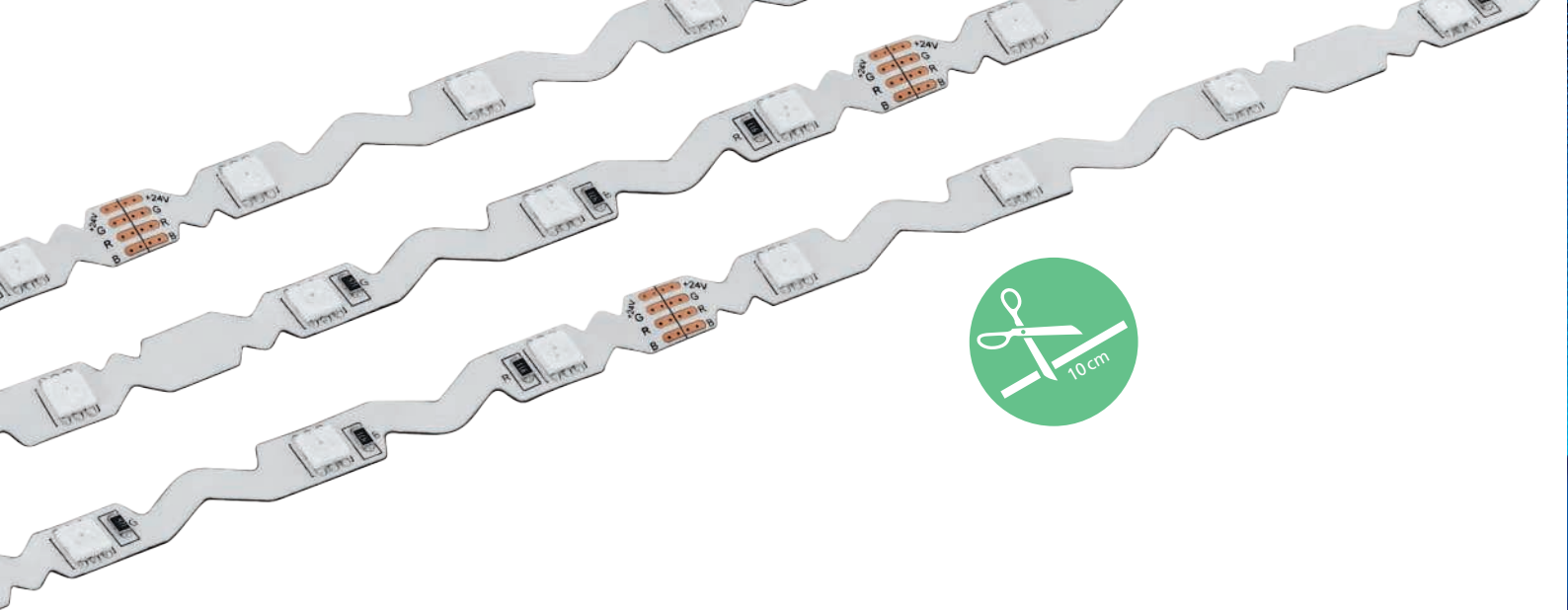

REMOTE CONTROL

With the aid of the remote control, all LED STRIPES can be dimmed. This note indicates that the remote control is included with the delivery.

Mit Hilfe der Fernbedienung können sämtliche LED-STRIPES gedimmt werden. Bei diesem Hinweis ist die Fernbedienung im Lieferumfang enthalten!

Au moyen de la télécommande, tous les LED STRIPES peuvent être gradués. Avec cette remarque, la télécommande est comprise dans l'étendue de la livraison !

99721, 99722, 99723

These articles include a remote control.

Bei diesen Artikeln ist eine Fernbedienung inkludiert.

Ces articles comprennent une télécommande.



99721 FLEXIBLE STRIPE

bar / strip light; white
Leuchtband/-stab; weiss
bande lumineuse / bâton l; blanc

L 2000, B 8



2x 4,6W

960lm



9 002759 997212

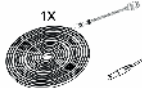

L 2000

99722 FLEXIBLE STRIPE

bar / strip light; white
Leuchtband/-stab; weiss
bande lumineuse / bâton l; blanc

L 5000, B 8



5x 4,6W

2400lm



9 002759 997229

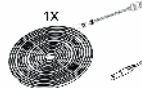

L 5000

99723 FLEXIBLE STRIPE

bar / strip light; white
Leuchtband/-stab; weiss
bande lumineuse / bâton l; blanc

L 8000, B 8



8x 4,6W

3840lm



9 002759 997236

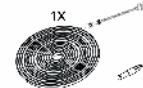

L 8000



98573



98574



98573 FLEXIBLE STRIPE

bar / strip light; plastic, white
Leuchtband/-stab; Kunststoff, weiss
bande lumineuse / bâton l; plastique, blanc

L 2000, B 8



9,7W



remote

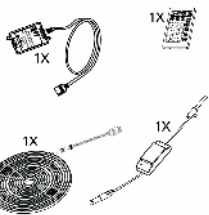

9 002759 985738

L 2000

98574 FLEXIBLE STRIPE

bar / strip light; plastic, white
Leuchtband/-stab; Kunststoff, weiss
bande lumineuse / bâton l; plastique, blanc

L 5000, B 8



19,5W



remote

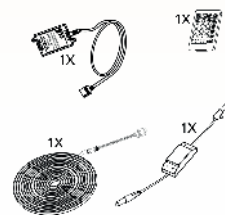

9 002759 985745

L 5000

98573, 98574

These articles include a remote control.

Bei diesen Artikeln ist eine Fernbedienung inkludiert.

Ces articles comprennent une télécommande.

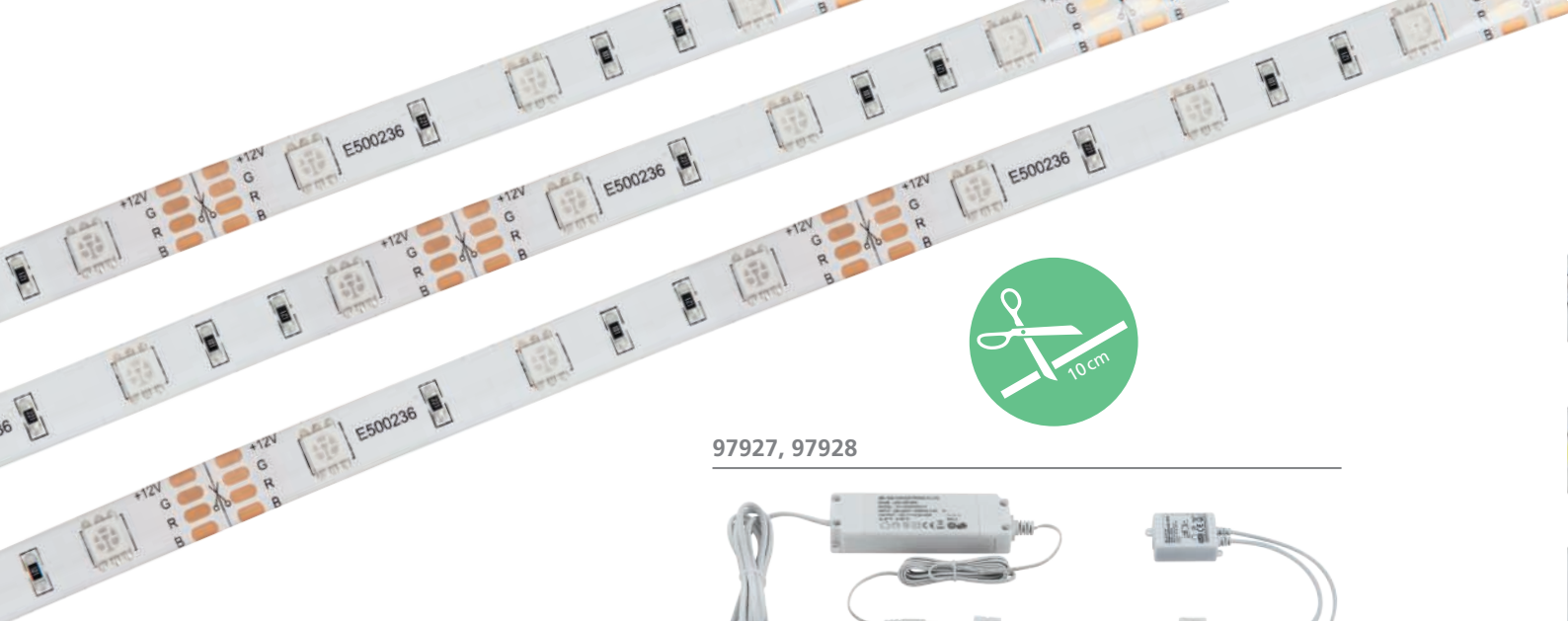

97927, 97928

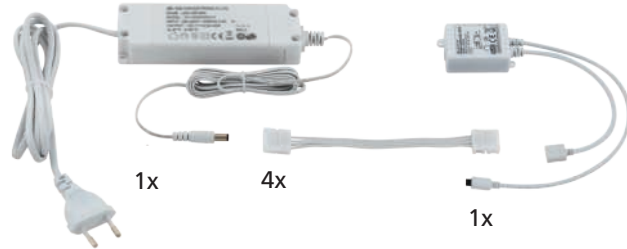

1x

4x

1x



99724



97927



97928

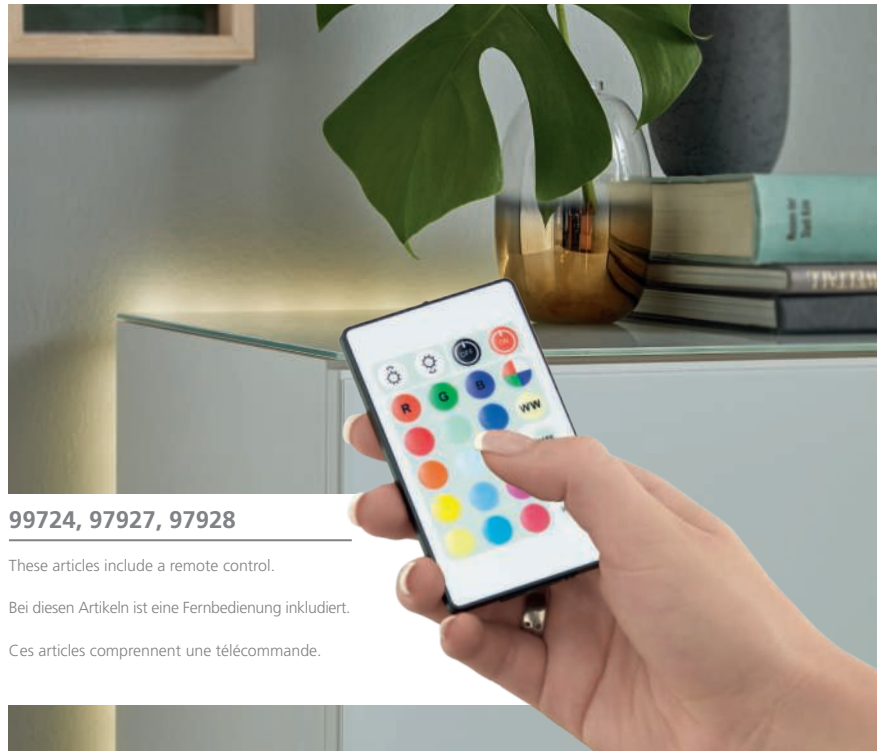

99724, 97927, 97928

These articles include a remote control.

Bei diesen Artikeln ist eine Fernbedienung inkludiert.

Ces articles comprennent une télécommande.

99724 FLEXIBLE STRIPE

bar / strip light; white
Leuchtband/-stab; weiss
bande lumineuse / bâton l; blanc

97927 LED STRIPES-FLEX

bar / strip light; plastic, transparent
Leuchtband/-stab; Kunststoff, transparent
bande lumineuse / bâton l; plastique, transparent

97928 LED STRIPES-FLEX

bar / strip light; plastic, transparent
Leuchtband/-stab; Kunststoff, transparent
bande lumineuse / bâton l; plastique, transparent

L 8000, B 8



38,4W

L 2000, B 10, H 3



10W

600lm

remote control

L 5000, B 10, H 3



20W

1000lm

remote control



9 002759 997243



L 8000



9 002759 979270



L 2000



9 002759 979287



L 5000

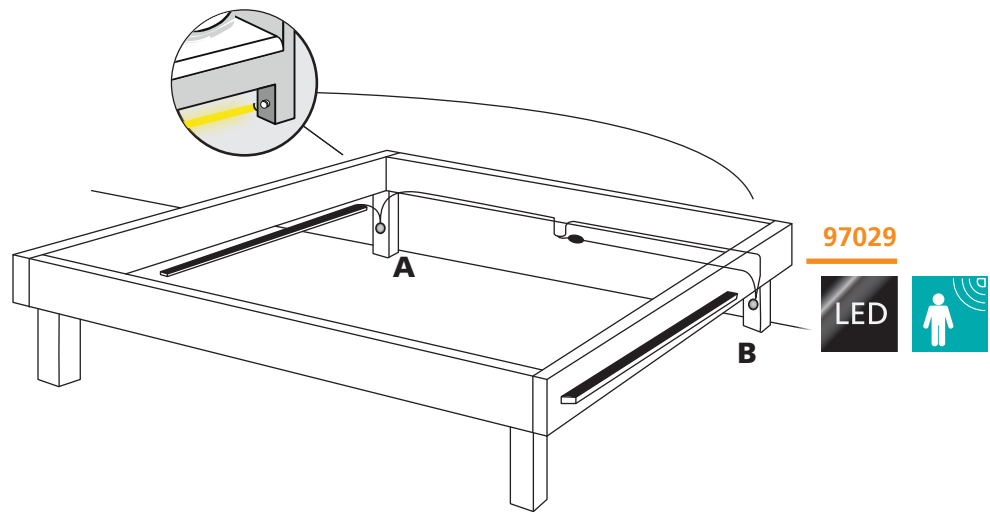
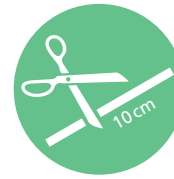

97029



97029 PIDIO

bar / strip light; plastic, white
 Leuchtband/-stab; Kunststoff, weiss
 bande lumineuse / bâton l; plastique, blanc

L 2400, B 8, H 2

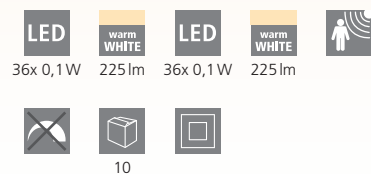

L 2400

PIDIO

This sensor strip is designed to be attached to the side of the bed. Properly placed and connected to the supplied LED lights, it will illuminate the base of your bed. The sensor has a 100 degree detection angle and a 3.5m range. It can be set to automatically activate the light between 30 seconds and 10 minutes.

Diese Sensorleiste ist so konzipiert, dass sie an der Seite des Bettes befestigt werden kann. Richtig platziert und mit den mitgelieferten LED-Streifenleuchten verbunden, kann damit ihr Bett unterleuchtet werden. Der Sensor hat einen 100 Grad Erfassungsbereich mit einer Reichweite von 3,5 m Reichweite. Er kann so eingestellt werden, dass das Licht zwischen 30 Sekunden und 10 Minuten automatisch aktiviert wird.

Cette barre de capteur est conçu de telle sorte qu'il peut être fixé sur le côté du lit. Correctement placé et connecté à la bande LED fournis, il allume la base du lit. Le capteur a un arc de 100 degrés et une portée de 3,5 m. Il peut être réglé de telle sorte que la lumière est activé entre 30 secondes et 10 minutes automatiquement.



LED PROFILES

ADVANTAGES

- > SIMPLE AND FAST INSTALLATION
 - > DIFFERENT SHAPES AND SIZES
 - > VARIETY OF COLOURS
 - > PROFILES GIVE LED STRIPES A MORE ELEGANT DESIGN
 - > PROTECTION AGAINST MECHANICAL STRESS OF THE LED STRIPES
-

VORTEILE

- > EINFACHE UND SCHNELLE MONTAGE
 - > UNTERSCHIEDLICHE FORMEN UND GRÖSSEN
 - > FARBENVIELFALT
 - > PROFILE VERLEIHEN LED-STRIPES EIN EDLERES DESIGN
 - > SCHUTZ VOR MECHANISCHER BEANSPRUCHUNG DER LED STRIPES
-

AVANTAGES

- > INSTALLATION SIMPLE ET RAPIDE
- > DIFFÉRENTES FORMES ET TAILLES
- > VARIÉTÉ DE COULEURS
- > LES PROFILS DONNENT AUX BANDES LED UN DESIGN PLUS ÉLÉGANT
- > PROTECTION CONTRE LES CONTRAINTES MÉCANIQUES DES BANDES LED

OVERVIEW



SURFACE
PROFILE 1
p. 300-302



SURFACE
PROFILE 2
p. 303-305



SURFACE
PROFILE 3
p. 306-308



CORNER
PROFILE 1
p. 310-315



CORNER
PROFILE 2
p. 316-321



SURFACE
PROFILE 4
p. 322-323



RECESSED
PROFILE 1
p. 324-326



RECESSED
PROFILE 2
p. 327-329



SURFACE
PROFILE 5
p. 330



RECESSED
PROFILE 3
p. 332-333



SURFACE
PROFILE 6
p. 334-335

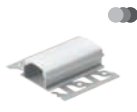

RECESSED
PROFILE 4
p. 336-339



This product is available in different colors and shapes./ Dieser Artikel ist in unterschiedlichen Farben und Formen verfügbar.
Cet article est disponible en différentes couleurs et formes.



LED CORNER CONNECTORS

ADVANTAGES

- > PREFABRICATED 90° CORNER CONNECTORS
 - > NO MITRE SAWING NECESSARY
 - > EASY MOUNTING
 - > SUITABLE FOR INSIDE AND OUTSIDE CORNERS
 - > BRACKETS INCLUDED
-

VORTEILE

- > VORGEFERTIGTE 90° ECKVERBINDER
 - > KEIN GEHRUNGSSÄGEN NOTWENDIG
 - > EINFACHE MONTAGE
 - > FÜR INNEN- UND AUSSENECKEN EINSETZBAR
 - > HALTERUNGEN INKLUSIVE
-

AVANTAGES

- > CONNECTEURS D'ANGLE À 90° PRÉFABRIQUÉS
- > PAS DE SCIAGE EN ONGLET NÉCESSAIRE
- > MONTAGE FACILE
- > CONVIENT AUX ANGLES INTÉRIEURS ET EXTÉRIEURS
- > ENTRE PARENTHÈSES

OVERVIEW

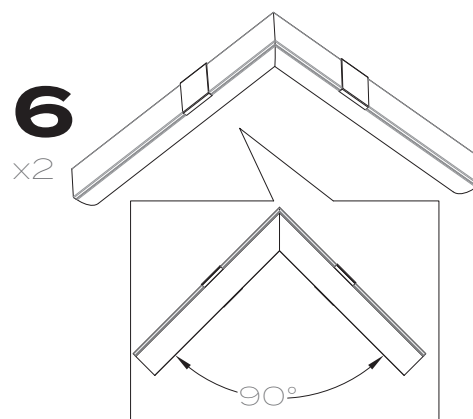
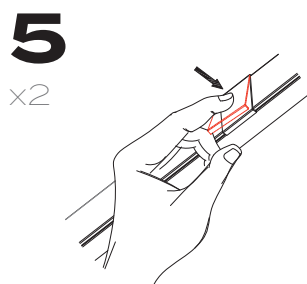
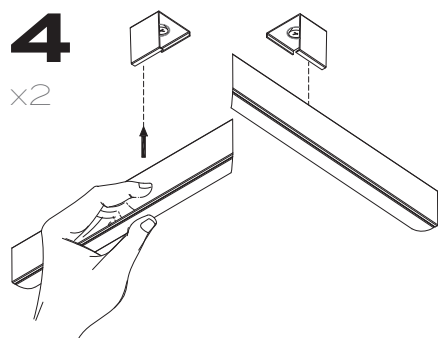
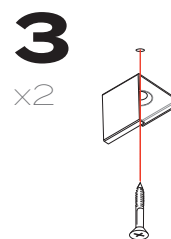
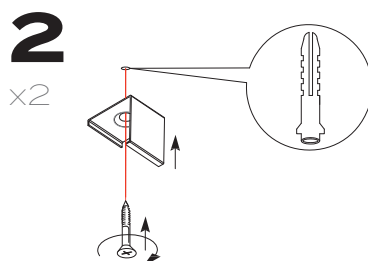
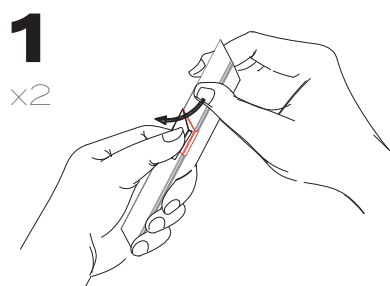

 This product is available in different colors and shapes./ Dieser Artikel ist in unterschiedlichen Farben und Formen verfügbar.
 Cet article est disponible en différentes couleurs et formes.

INCLUDED IN DELIVERY /
im Lieferumfang enthalten /
inclus dans la livraison



98911
98912



98914
98915

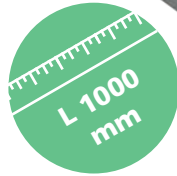

98911



98912

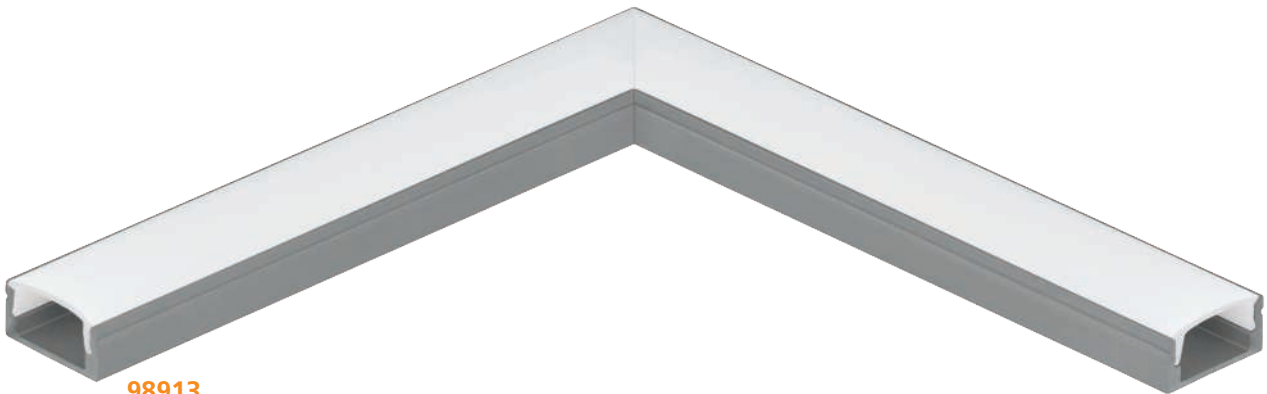

98913

98911 SURFACE PROFILE 1

accessory; aluminium, aluminium / plastic, white
Zubehör; Alu, alu / Kunststoff, weiss
accessoire; aluminium, aluminium / plastique, blanc

L 1000, B 17, H 9



9 002759 989118

98912 SURFACE PROFILE 1

accessory; aluminium, aluminium / plastic, white
Zubehör; Alu, alu / Kunststoff, weiss
accessoire; aluminium, aluminium / plastique, blanc

L 2000, B 17, H 9



9 002759 989125

98913 SURFACE PROFILE 1

accessory; aluminium, aluminium
Zubehör; Alu, alu
accessoire; aluminium, aluminium

L 110



9 002759 989132

SURFACE PROFILES

incl. end caps & mounting clips



98914

L 1000
mm

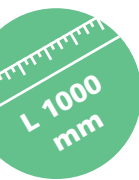
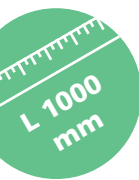

98915

L 2000
mm

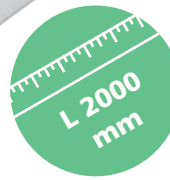

98916

98914 SURFACE PROFILE 1

accessory; aluminium, white / plastic, white
Zubehör; Alu, weiss / Kunststoff, weiss
accessoire; aluminium, blanc / plastique, blanc

L 1000, B 17, H 9



98915 SURFACE PROFILE 1

accessory; aluminium, white / plastic, white
Zubehör; Alu, weiss / Kunststoff, weiss
accessoire; aluminium, blanc / plastique, blanc

L 2000, B 17, H 9



98916 SURFACE PROFILE 1

accessory; aluminium, white
Zubehör; Alu, weiss
accessoire; aluminium, blanc

L 110



PROFILE CROSS-SECTION / Profilquerschnitt / section de profil

98911 98913 98915
98912 98914 98916

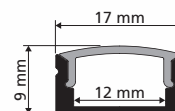



INCLUDED IN DELIVERY /

im Lieferumfang enthalten /
inclus dans la livraison



98917
98918



98921
98922

98917

L 1000
mm

98918

L 2000
mm

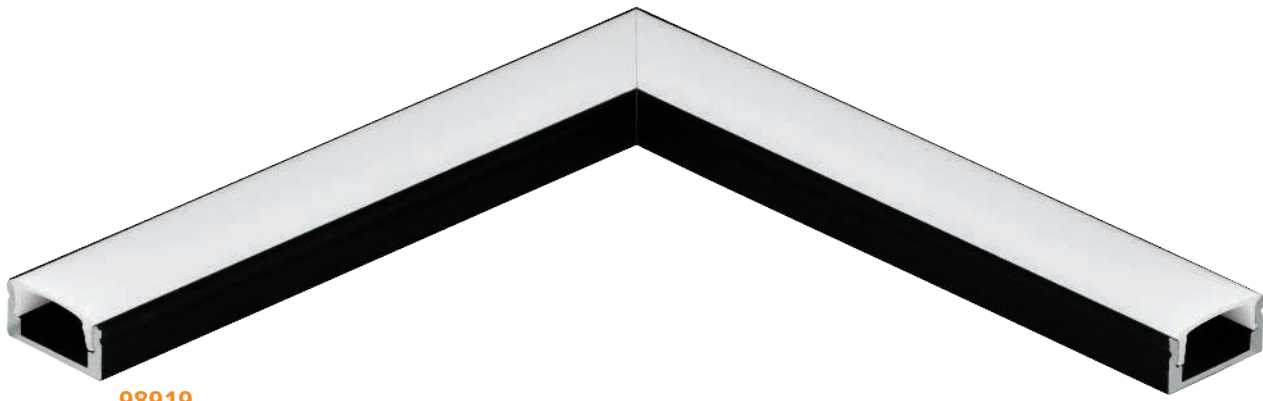

98919

98917 SURFACE PROFILE 1

accessory; aluminium, black / plastic, white
Zubehör; Alu, schwarz / Kunststoff, weiss
accessoire; aluminium, noir / plastique, blanc

98918 SURFACE PROFILE 1

accessory; aluminium, black / plastic, white
Zubehör; Alu, schwarz / Kunststoff, weiss
accessoire; aluminium, noir / plastique, blanc

98919 SURFACE PROFILE 1

accessory; aluminium, anodised black
Zubehör; Alu, schwarz eloxiert
accessoire; aluminium, noir anodisé

L 1000, B 17, H 9



9 002759 989170

L 2000, B 17, H 9



9 002759 989187

L 110



9 002759 989194

SURFACE PROFILES

incl. end caps & mounting clips

PROFILE CROSS-SECTION /
Profilquerschnitt / section de profil

98917 98919
98918

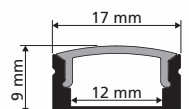



L 1000 mm

98921



L 2000 mm

98922

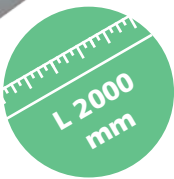

98923

98921 SURFACE PROFILE 2

accessory; aluminium, aluminium / plastic, white
Zubehör; Alu, alu / Kunststoff, weiss
accessoire; aluminium, aluminium / plastique, blanc

L 1000, B 17, H 16



9 002759 989217

98922 SURFACE PROFILE 2

accessory; aluminium, aluminium / plastic, white
Zubehör; Alu, alu / Kunststoff, weiss
accessoire; aluminium, aluminium / plastique, blanc

L 2000, B 17, H 16



9 002759 989224

98923 SURFACE PROFILE 2

accessory; aluminium, aluminium
Zubehör; Alu, alu
accessoire; aluminium, aluminium

L 110



9 002759 989231

PROFILE CROSS-SECTION / Profilquerschnitt / section de profil

98921 98923
98922

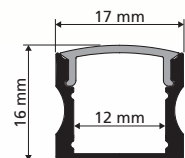



L 1000
mm

98924



L 2000
mm

98925

INCLUDED IN DELIVERY /
im Lieferumfang enthalten /
inclus dans la livraison



98924
98925



98927
98928



98926

98924 SURFACE PROFILE 2

accessory; aluminium, white / plastic, white
Zubehör; Alu, weiss / Kunststoff, weiss
accessoire; aluminium, blanc / plastique, blanc

L 1000, B 17, H 16



9 002759 989248

98925 SURFACE PROFILE 2

accessory; aluminium, white / plastic, white
Zubehör; Alu, weiss / Kunststoff, weiss
accessoire; aluminium, blanc / plastique, blanc

L 2000, B 17, H 16



9 002759 989255

98926 SURFACE PROFILE 2

accessory; aluminium, white
Zubehör; Alu, weiss
accessoire; aluminium, blanc

L 110



9 002759 989262

SURFACE PROFILES

incl. end caps & mounting clips



98927

L 1000
mm



98928

L 2000
mm



98929

98927 SURFACE PROFILE 2

accessory; aluminium, black / plastic, white
Zubehör; Alu, schwarz / Kunststoff, weiss
accessoire; aluminium, noir / plastique, blanc

L 1000, B 17, H 16



98928 SURFACE PROFILE 2

accessory; aluminium, black / plastic, white
Zubehör; Alu, schwarz / Kunststoff, weiss
accessoire; aluminium, noir / plastique, blanc

L 2000, B 17, H 16



98929 SURFACE PROFILE 2

accessory; aluminium, anodised black
Zubehör; Alu, schwarz eloxiert
accessoire; aluminium, noir anodisé

L 110



PROFILE CROSS-SECTION /
Profilquerschnitt / section de profil

98924 98926 98928
98925 98927 98929

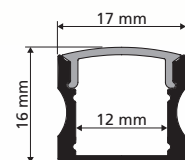



L 1000
mm

98931



L 2000
mm

98932



98933

INCLUDED IN DELIVERY /
im Lieferumfang enthalten /
inclus dans la livraison



98931
98932



98937
98938



98931 SURFACE PROFILE 3

accessory; aluminium, aluminium / plastic, transparent
Zubehör; Alu, alu / Kunststoff, transparent
accessoire; aluminium, aluminium / plastique, transparent

L 1000, B 17, H 20



9 002759 989316

98932 SURFACE PROFILE 3

accessory; aluminium, aluminium / plastic, transparent
Zubehör; Alu, alu / Kunststoff, transparent
accessoire; aluminium, aluminium / plastique, transparent

L 2000, B 17, H 20



9 002759 989323

98933 SURFACE PROFILE 3

accessory; aluminium, aluminium
Zubehör; Alu, alu
accessoire; aluminium, aluminium

L 110



9 002759 989330

SURFACE PROFILES WITH 30° LINEAR LENS

incl. end caps & mounting clips



98937

L 1000
mm



98938

L 2000
mm



98939

98937 SURFACE PROFILE 3

accessory; aluminium, black / plastic, transparent
Zubehör; Alu, schwarz / Kunststoff, transparent
accessoire; aluminium, noir / plastique, transparent

L 1000, B 17, H 20



98938 SURFACE PROFILE 3

accessory; aluminium, black / plastic, transparent
Zubehör; Alu, schwarz / Kunststoff, transparent
accessoire; aluminium, noir / plastique, transparent

L 2000, B 17, H 20



98939 SURFACE PROFILE 3

accessory; aluminium, anodised black
Zubehör; Alu, schwarz eloxiert
accessoire; aluminium, noir anodisé

L 110



PROFILE CROSS-SECTION / Profilquerschnitt / section de profil

98931 98933 98938
98932 98937 98939

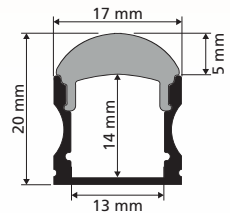

INCLUDED IN DELIVERY /
im Lieferumfang enthalten /
inclus dans la livraison



98934
98935



98934



98935



98936

98934 SURFACE PROFILE 3

accessory; aluminium, white / plastic, transparent
Zubehör; Alu, weiss / Kunststoff, transparent
accessoire; aluminium, blanc / plastique, transparent

L 1000, B 17, H 20



98935 SURFACE PROFILE 3

accessory; aluminium, white / plastic, transparent
Zubehör; Alu, weiss / Kunststoff, transparent
accessoire; aluminium, blanc / plastique, transparent

L 2000, B 17, H 20



98936 SURFACE PROFILE 3

accessory; aluminium, white
Zubehör; Alu, weiss
accessoire; aluminium, blanc

L 110



SURFACE PROFILES WITH 30° LINEAR LENS

incl. end caps & mounting clips



PROFILE CROSS-SECTION /
Profilquerschnitt / section de profil

98934 98936
98935

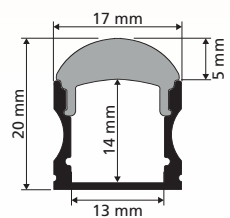

INCLUDED IN DELIVERY /
im Lieferumfang enthalten /
inclus dans la livraison



98941
98942



98941



98942



98943

98941 CORNER PROFILE 1

accessory; aluminium, aluminium / plastic, white
Zubehör; Alu, alu / Kunststoff, weiss
accessoire; aluminium, aluminium / plastique, blanc

L 1000, H 16



9 002759 989415

98942 CORNER PROFILE 1

accessory; aluminium, aluminium / plastic, white
Zubehör; Alu, alu / Kunststoff, weiss
accessoire; aluminium, aluminium / plastique, blanc

L 2000, H 16



9 002759 989422

98943 CORNER PROFILE 1

accessory; aluminium, aluminium
Zubehör; Alu, alu
accessoire; aluminium, aluminium

L 110



9 002759 989439

CORNER PROFILES

incl. end caps & mounting clips

98944



98944 CORNER PROFILE 1

accessory; aluminium, aluminium
Zubehör; Alu, alu
accessoire; aluminium, aluminium

L 110



9 002759 989446

PROFILE CROSS-SECTION /
Profilquerschnitt / section de profil

98941 98943
98942 98944

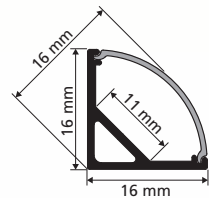

INCLUDED IN DELIVERY /
im Lieferumfang enthalten /
inclus dans la livraison

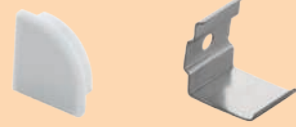

98945
98946

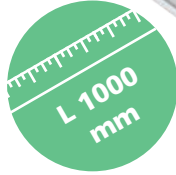

98945

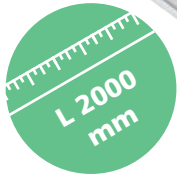

98946



98947

98945 CORNER PROFILE 1

accessory; aluminium, white / plastic, white
Zubehör; Alu, weiss / Kunststoff, weiss
accessoire; aluminium, blanc / plastique, blanc

L 1000, H 16



9 002759 989453

98946 CORNER PROFILE 1

accessory; aluminium, white / plastic, white
Zubehör; Alu, weiss / Kunststoff, weiss
accessoire; aluminium, blanc / plastique, blanc

L 2000, H 16



9 002759 989460

98947 CORNER PROFILE 1

accessory; aluminium, white
Zubehör; Alu, weiss
accessoire; aluminium, blanc

L 110



9 002759 989477

CORNER PROFILES

incl. end caps & mounting clips

PROFILE CROSS-SECTION / Profilquerschnitt / section de profil

98945 98947
98946 98948

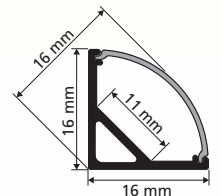

98948

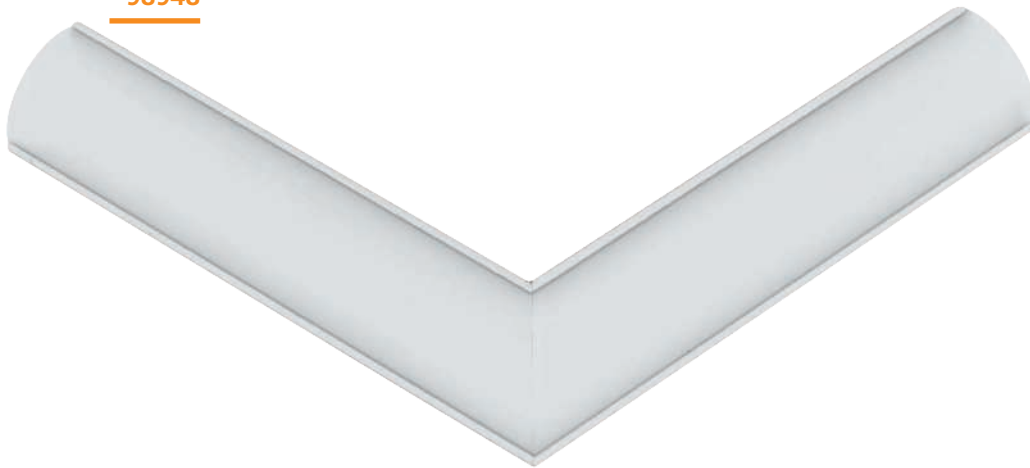

98948 CORNER PROFILE 1

accessory; aluminium, white
Zubehör; Alu, weiss
accessoire; aluminium, blanc

L 110



INCLUDED IN DELIVERY /
im Lieferumfang enthalten /
inclus dans la livraison



98949
98951

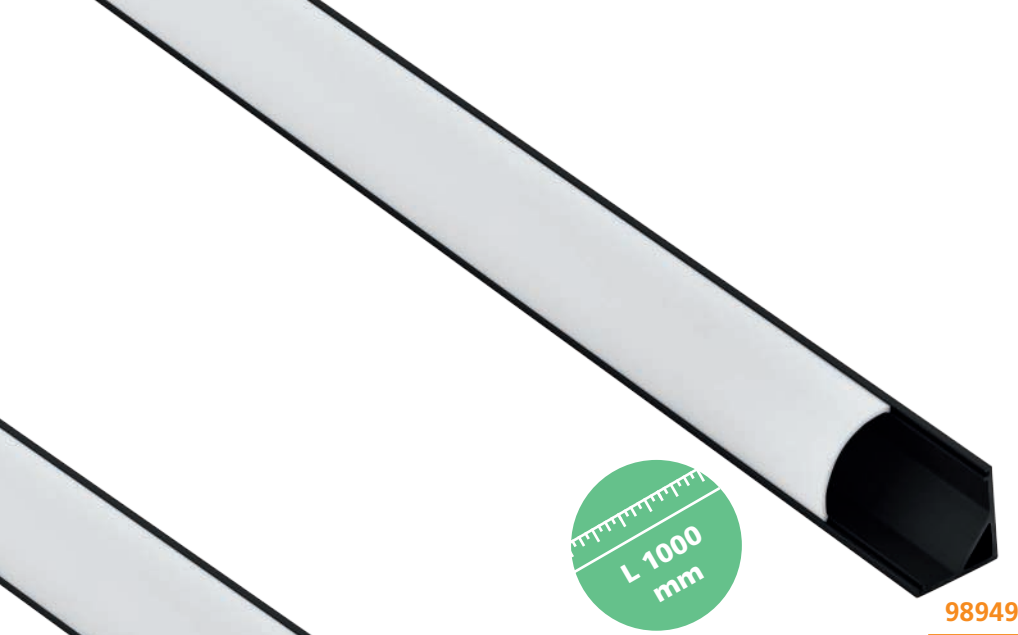

L 1000
mm

98949

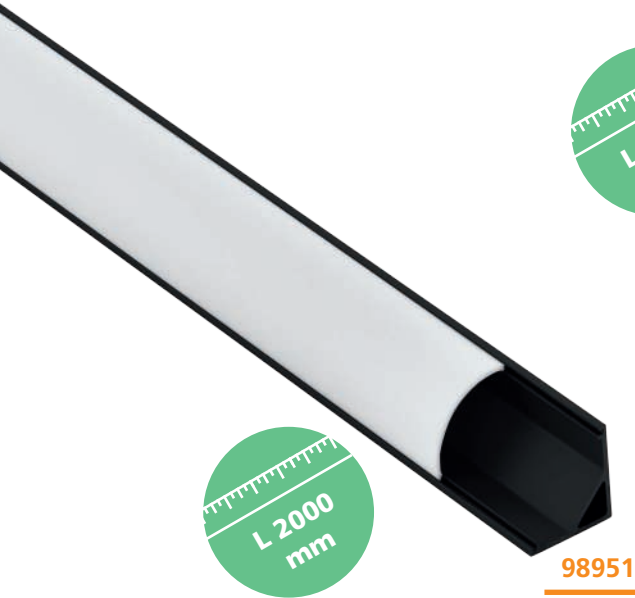

L 2000
mm

98951

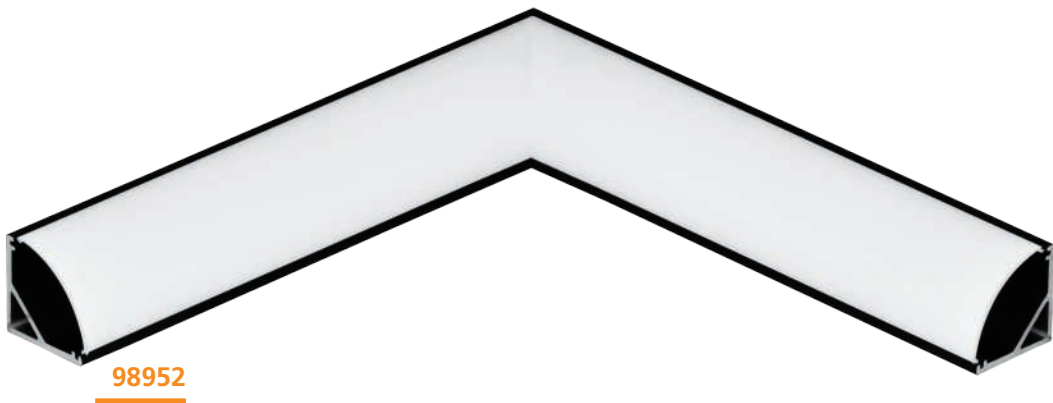

98952

98949 CORNER PROFILE 1

accessory; aluminium, black / plastic, white
Zubehör; Alu, schwarz / Kunststoff, weiss
accessoire; aluminium, noir / plastique, blanc

L 1000, H 16



9 002759 989491

98951 CORNER PROFILE 1

accessory; aluminium, black / plastic, white
Zubehör; Alu, schwarz / Kunststoff, weiss
accessoire; aluminium, noir / plastique, blanc

L 2000, H 16



9 002759 989514

98952 CORNER PROFILE 1

accessory; aluminium, anodised black
Zubehör; Alu, schwarz eloxiert
accessoire; aluminium, noir anodisé

L 110



9 002759 989521

CORNER PROFILES

incl. end caps & mounting clips

98953

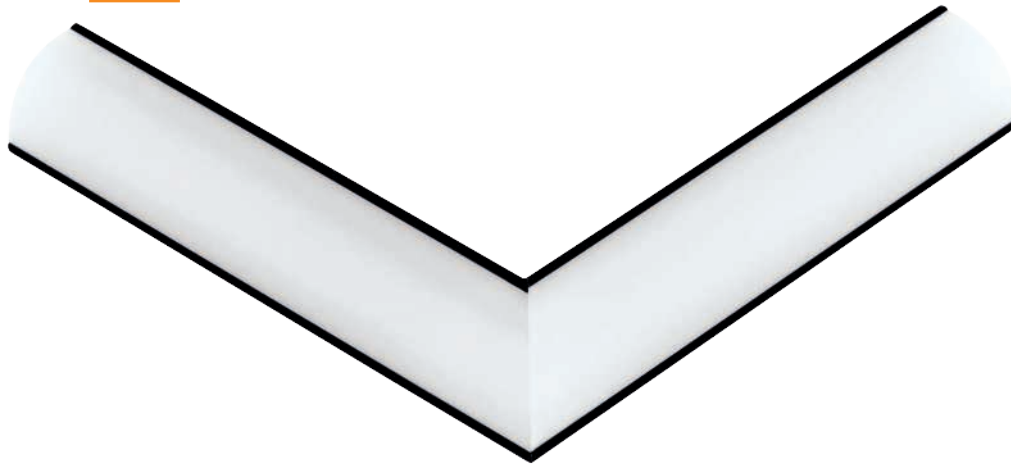

98953 CORNER PROFILE 1

accessory; aluminium, anodised black
Zubehör; Alu, schwarz eloxiert
accessoire; aluminium, noir anodisé

L 110



9 002759 989538

PROFILE CROSS-SECTION / Profilquerschnitt / section de profil

98949 98952
98951 98953

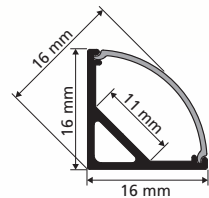

INCLUDED IN DELIVERY /
im Lieferumfang enthalten /
inclus dans la livraison



98954
98955

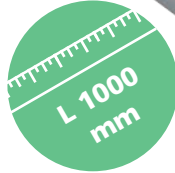

98954

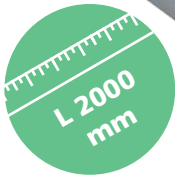

98955



98956

98954 CORNER PROFILE 2

accessory; aluminium, aluminium / plastic, white
Zubehör; Alu, alu / Kunststoff, weiss
accessoire; aluminium, aluminium / plastique, blanc

L 1000, B 18, H 18



9 002759 989545

98955 CORNER PROFILE 2

accessory; aluminium, aluminium / plastic, white
Zubehör; Alu, alu / Kunststoff, weiss
accessoire; aluminium, aluminium / plastique, blanc

L 2000, B 18, H 18



9 002759 989552

98956 CORNER PROFILE 2

accessory; aluminium, aluminium
Zubehör; Alu, alu
accessoire; aluminium, aluminium

L 110



9 002759 989569

CORNER PROFILES

incl. end caps & mounting clips

PROFILE CROSS-SECTION / Profilquerschnitt / section de profil

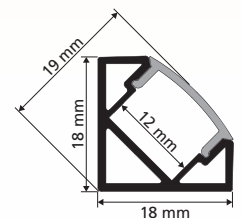

98954 98956
98955 98957

98957

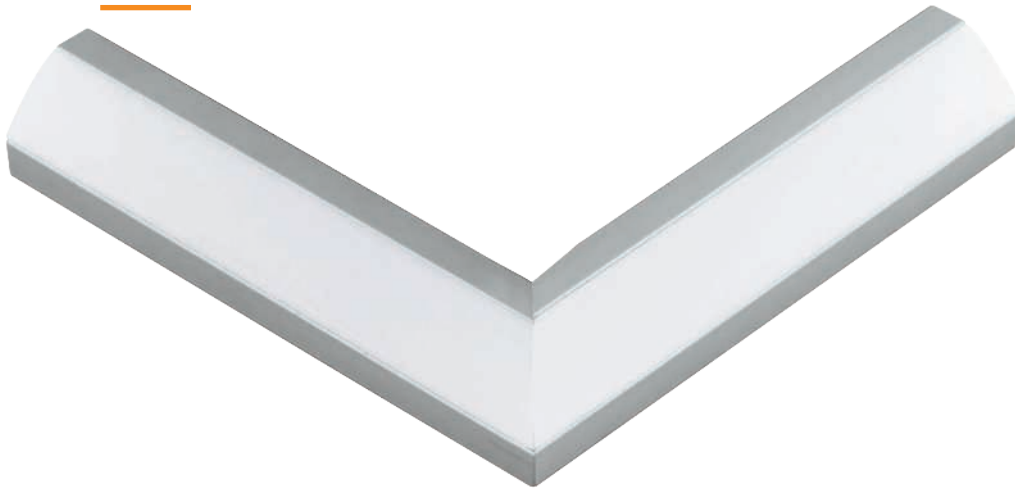

98957 CORNER PROFILE 2

accessory; aluminium, aluminium
Zubehör; Alu, alu
accessoire; aluminium, aluminium

L 110



INCLUDED IN DELIVERY /
im Lieferumfang enthalten /
inclus dans la livraison



98958
98959

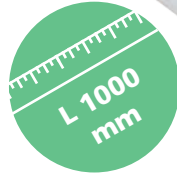

98958



98959



98961

98958 CORNER PROFILE 2

accessory; aluminium, white / plastic, white
Zubehör; Alu, weiss / Kunststoff, weiss
accessoire; aluminium, blanc / plastique, blanc

L 1000, B 18, H 18



9 002759 989583

98959 CORNER PROFILE 2

accessory; aluminium, white / plastic, white
Zubehör; Alu, weiss / Kunststoff, weiss
accessoire; aluminium, blanc / plastique, blanc

L 2000, B 18, H 18



9 002759 989590

98961 CORNER PROFILE 2

accessory; aluminium, white
Zubehör; Alu, weiss
accessoire; aluminium, blanc

L 110



9 002759 989613

CORNER PROFILES

incl. end caps & mounting clips

98962



98962 CORNER PROFILE 2

accessory; aluminium, white
Zubehör; Alu, weiss
accessoire; aluminium, blanc

L 110



9 002759 989620

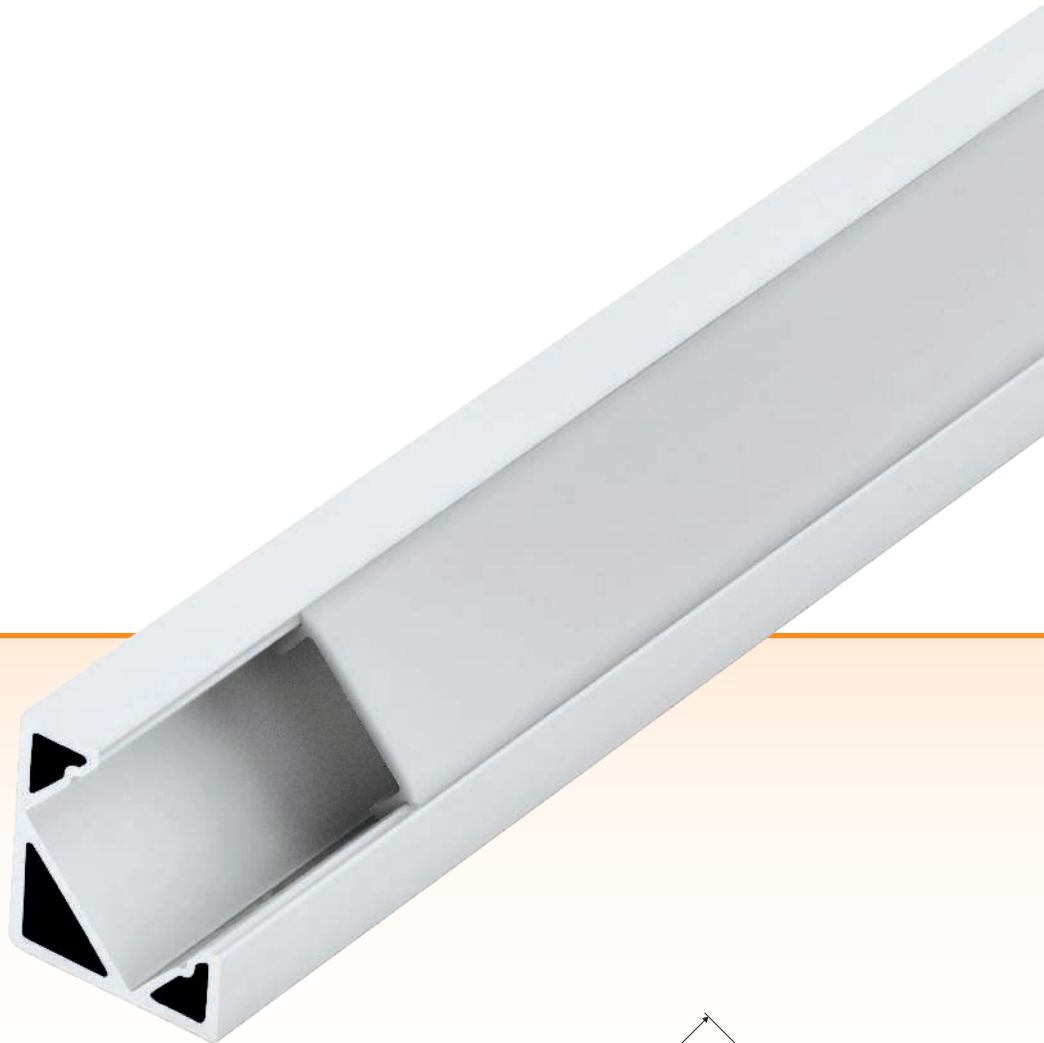

PROFILE CROSS-SECTION / Profilquerschnitt / section de profil

98958 98961
98959 98962

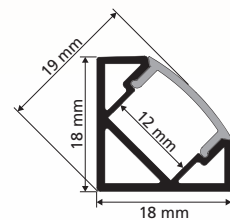

INCLUDED IN DELIVERY /
im Lieferumfang enthalten /
inclus dans la livraison



98963
98964

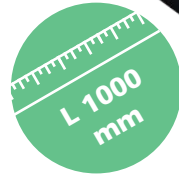

98963

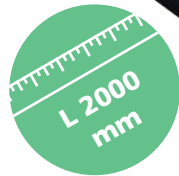

98964



98965

98963 CORNER PROFILE 2

accessory; aluminium, black / plastic, white
Zubehör; Alu, schwarz / Kunststoff, weiss
accessoire; aluminium, noir / plastique, blanc

98964 CORNER PROFILE 2

accessory; aluminium, black / plastic, white
Zubehör; Alu, schwarz / Kunststoff, weiss
accessoire; aluminium, noir / plastique, blanc

98965 CORNER PROFILE 2

accessory; aluminium, anodised black
Zubehör; Alu, schwarz eloxiert
accessoire; aluminium, noir anodisé

L 1000, B 18, H 18



9 002759 989637

L 2000, B 18, H 18



9 002759 989644

L 110



9 002759 989651

CORNER PROFILES

incl. end caps & mounting clips

98966

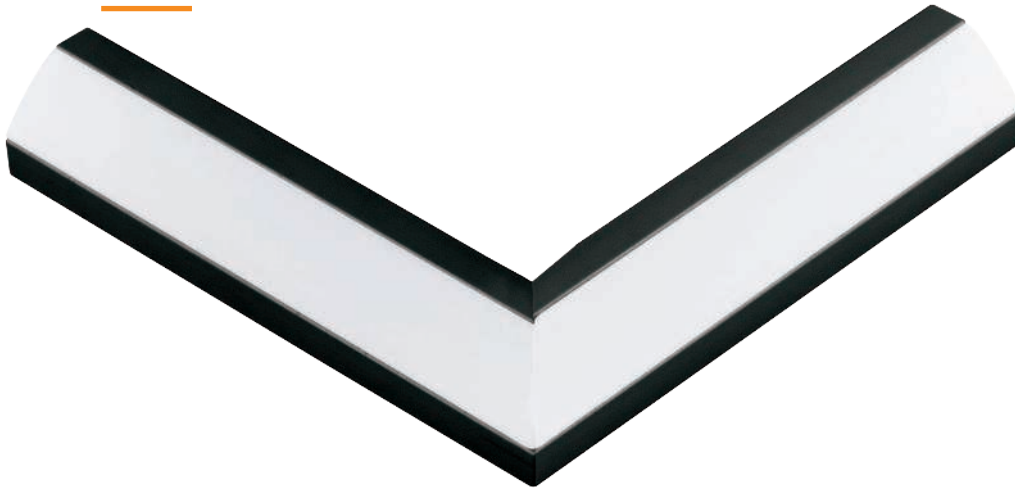

98966 CORNER PROFILE 2

accessory; aluminium, anodised black
Zubehör; Alu, schwarz eloxiert
accessoire; aluminium, noir anodisé

L 110



9 002759 989668

PROFILE CROSS-SECTION /
Profilquerschnitt / section de profil

98963 98965
98964 98966

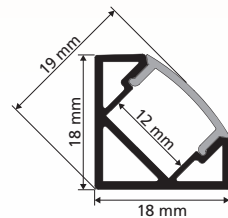



98967

98968

98971

INCLUDED IN DELIVERY /
im Lieferumfang enthalten /
inclus dans la livraison



98967
98968



98971
98972



98974
98975

98967 SURFACE PROFILE 4

accessory; aluminium, aluminium / plastic, satined
Zubehör; Alu, alu / Kunststoff, satiniert
accessoire; aluminium, aluminium / plastique, satiné

L 1000, B 18, H 48



9 002759 989675

98968 SURFACE PROFILE 4

accessory; aluminium, aluminium / plastic, satined
Zubehör; Alu, alu / Kunststoff, satiniert
accessoire; aluminium, aluminium / plastique, satiné

L 2000, B 18, H 48



9 002759 989682

98971 SURFACE PROFILE 4

accessory; aluminium, white / plastic, satined
Zubehör; Alu, weiss / Kunststoff, satiniert
accessoire; aluminium, blanc / plastique, satiné

L 1000, B 18, H 48



9 002759 989712

WALL CONSTRUCTION PROFILES

incl. end caps & mounting clips



98972



98974

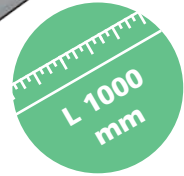

98975

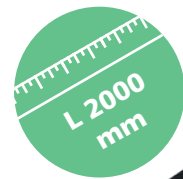

98972 SURFACE PROFILE 4

accessory; aluminium, white / plastic, satiné
 Zubehör; Alu, weiss / Kunststoff, satiniert
 accessoire; aluminium, blanc / plastique, satiné

L 2000, B 18, H 48



9 002759 989729

98974 SURFACE PROFILE 4

accessory; aluminium, black / plastic, satiné
 Zubehör; Alu, schwarz / Kunststoff, satiniert
 accessoire; aluminium, noir / plastique, satiné

L 1000, B 18, H 48



9 002759 989743

98975 SURFACE PROFILE 4

accessory; aluminium, black / plastic, satiné
 Zubehör; Alu, schwarz / Kunststoff, satiniert
 accessoire; aluminium, noir / plastique, satiné

L 2000, B 18, H 48



9 002759 989750

PROFILE CROSS-SECTION /
 Profilquerschnitt / section de profil

98967 98971 98974
 98968 98972 98975

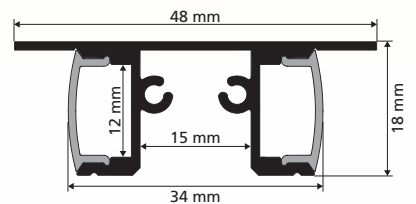



98977



98978



98979

INCLUDED IN DELIVERY /
im Lieferumfang enthalten /
inclus dans la livraison



98977
98978



98981
98982

98977 RECESSED PROFILE 1

accessory; aluminium, aluminium / plastic, white
Zubehör; Alu, alu / Kunststoff, weiss
accessoire; aluminium, aluminium / plastique, blanc

L 1000, B 23, H 9



9 002759 989774

98978 RECESSED PROFILE 1

accessory; aluminium, aluminium / plastic, white
Zubehör; Alu, alu / Kunststoff, weiss
accessoire; aluminium, aluminium / plastique, blanc

L 2000, B 23, H 9



9 002759 989781

98979 RECESSED PROFILE 1

accessory; aluminium, aluminium
Zubehör; Alu, alu
accessoire; aluminium, aluminium

L 110



9 002759 989798

INSTALLATION PROFILES

incl. end caps & mounting clips



98981

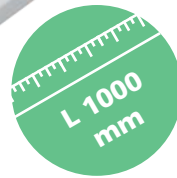

98982

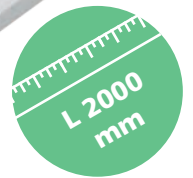

98983

98981 RECESSED PROFILE 1

accessory; aluminium, white / plastic, white
Zubehör; Alu, weiss / Kunststoff, weiss
accessoire; aluminium, blanc / plastique, blanc

L 1000, B 23, H 9



98982 RECESSED PROFILE 1

accessory; aluminium, white / plastic, white
Zubehör; Alu, weiss / Kunststoff, weiss
accessoire; aluminium, blanc / plastique, blanc

L 2000, B 23, H 9



98983 RECESSED PROFILE 1

accessory; aluminium, white
Zubehör; Alu, weiss
accessoire; aluminium, blanc

L 110



PROFILE CROSS-SECTION /
Profilquerschnitt / section de profil

98977 98979 98982
98978 98981 98983

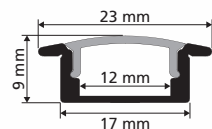

INCLUDED IN DELIVERY /
im Lieferumfang enthalten /
inclus dans la livraison



98984
98985



98987
98988



L 1000
mm

98984



L 2000
mm

98985



98986

98984 RECESSED PROFILE 1

accessory; aluminium, black / plastic, white
Zubehör; Alu, schwarz / Kunststoff, weiss
accessoire; aluminium, noir / plastique, blanc

98985 RECESSED PROFILE 1

accessory; aluminium, black / plastic, white
Zubehör; Alu, schwarz / Kunststoff, weiss
accessoire; aluminium, noir / plastique, blanc

98986 RECESSED PROFILE 1

accessory; aluminium, anodised black
Zubehör; Alu, schwarz eloxiert
accessoire; aluminium, noir anodisé

L 1000, B 23, H 9



9 002759 989842

L 2000, B 23, H 9



9 002759 989859

L 110



9 002759 989866

INSTALLATION PROFILES

incl. end caps

PROFILE CROSS-SECTION / Profilquerschnitt / section de profil

98984 98986
98985

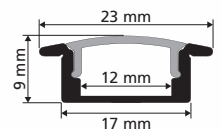



98987

L 1000
mm

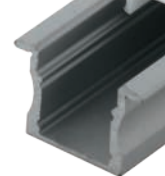
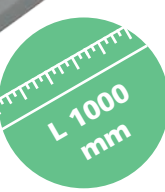
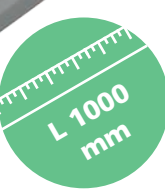

L 2000
mm

98988



98989

98987 RECESSED PROFILE 2

accessory; aluminium, aluminium / plastic, white
Zubehör; Alu, alu / Kunststoff, weiss
accessoire; aluminium, aluminium / plastique, blanc

L 1000, B 23, H 15



9 002759 989873

98988 RECESSED PROFILE 2

accessory; aluminium, aluminium / plastic, white
Zubehör; Alu, alu / Kunststoff, weiss
accessoire; aluminium, aluminium / plastique, blanc

L 2000, B 23, H 15



9 002759 989880

98989 RECESSED PROFILE 2

accessory; aluminium, aluminium
Zubehör; Alu, alu
accessoire; aluminium, aluminium

L 110



9 002759 989897

PROFILE CROSS-SECTION / Profilquerschnitt / section de profil

98987 98989
98988

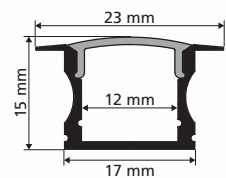



L 1000
mm

98991



L 2000
mm

98992



98993

INCLUDED IN DELIVERY /
im Lieferumfang enthalten /
inclus dans la livraison



98991
98992



98994
98995

98991 RECESSED PROFILE 2

accessory; aluminium, white / plastic, white
Zubehör; Alu, weiss / Kunststoff, weiss
accessoire; aluminium, blanc / plastique, blanc

L 1000, B 23, H 15



9 002759 989910

98992 RECESSED PROFILE 2

accessory; aluminium, white / plastic, white
Zubehör; Alu, weiss / Kunststoff, weiss
accessoire; aluminium, blanc / plastique, blanc

L 2000, B 23, H 15



9 002759 989927

98993 RECESSED PROFILE 2

accessory; aluminium, white
Zubehör; Alu, weiss
accessoire; aluminium, blanc

L 110



9 002759 989934

INSTALLATION PROFILES

incl. end caps



98994



98995



98996

98994 RECESSED PROFILE 2

accessory; aluminium, black / plastic, white
 Zubehör; Alu, schwarz / Kunststoff, weiss
 accessoire; aluminium, noir / plastique, blanc

L 1000, B 23, H 15



98995 RECESSED PROFILE 2

accessory; aluminium, black / plastic, white
 Zubehör; Alu, schwarz / Kunststoff, weiss
 accessoire; aluminium, noir / plastique, blanc

L 2000, B 23, H 15



98996 RECESSED PROFILE 2

accessory; aluminium, anodised black
 Zubehör; Alu, schwarz eloxiert
 accessoire; aluminium, noir anodisé

L 110



PROFILE CROSS-SECTION / Profilquerschnitt / section de profil

98991 98993 98995
 98992 98994 98996

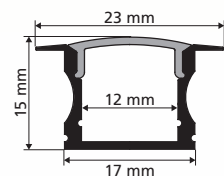



L 1000
mm

98997

INCLUDED IN DELIVERY /
im Lieferumfang enthalten /
inclus dans la livraison



98997
98998



L 2000
mm

98998

98997 SURFACE PROFILE 5

accessory; aluminium, black / plastic, white
Zubehör; Alu, schwarz / Kunststoff, weiss
accessoire; aluminium, noir / plastique, blanc

L 1000, B 80, H 50



9 002759 989972

98998 SURFACE PROFILE 5

accessory; aluminium, black / plastic, white
Zubehör; Alu, schwarz / Kunststoff, weiss
accessoire; aluminium, noir / plastique, blanc

L 2000, B 80, H 50



9 002759 989989

STAIR PROFILES

incl. end caps

PROFILE CROSS-SECTION /
Profilquerschnitt / section de profil

98997
98998

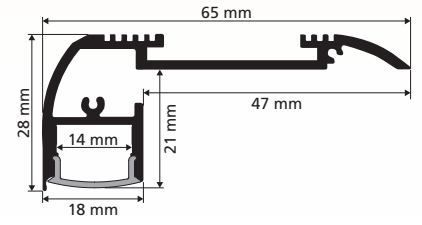





INCLUDED IN DELIVERY /
im Lieferumfang enthalten /
inclus dans la livraison



99004
99005



99002
99003



98999
99001

99003 RECESSED PROFILE 3

accessory; aluminium, white / plastic, white
Zubehör; Alu, weiss / Kunststoff, weiss
accessoire; aluminium, blanc / plastique, blanc

L 2000, B 65, H 45



9 002759 990039

99002 RECESSED PROFILE 3

accessory; aluminium, white / plastic, white
Zubehör; Alu, weiss / Kunststoff, weiss
accessoire; aluminium, blanc / plastique, blanc

L 1000, B 65, H 45



9 002759 990022

99005 RECESSED PROFILE 3

accessory; aluminium, black / plastic, white
Zubehör; Alu, schwarz / Kunststoff, weiss
accessoire; aluminium, noir / plastique, blanc

L 2000, B 65, H 45



9 002759 990053

INSTALLATION PROFILES LARGE

incl. end caps

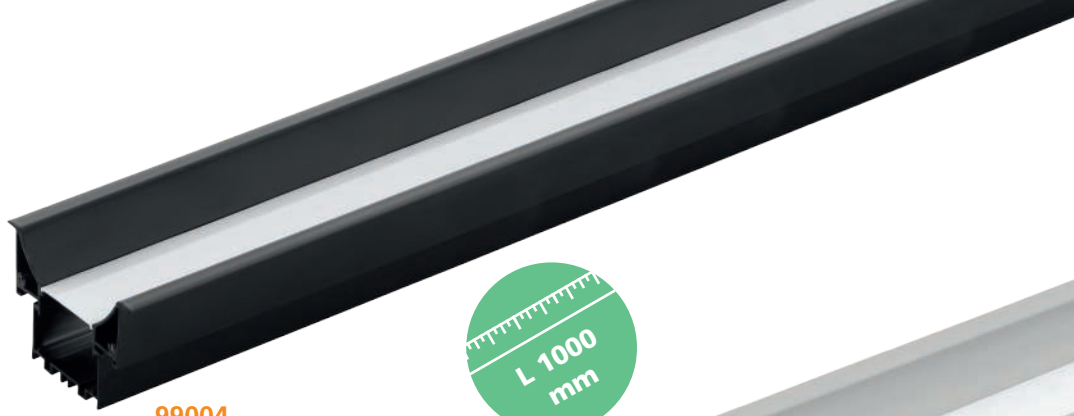

99004



98999



99001

99004 RECESSED PROFILE 3

accessory; aluminium, black / plastic, white
Zubehör; Alu, schwarz / Kunststoff, weiss
accessoire; aluminium, noir / plastique, blanc

L 1000, B 65, H 45



98999 RECESSED PROFILE 3

accessory; aluminium, aluminium / plastic, white
Zubehör; Alu, alu / Kunststoff, weiss
accessoire; aluminium, aluminium / plastique, blanc

L 1000, B 65, H 45



99001 RECESSED PROFILE 3

accessory; aluminium, aluminium / plastic, white
Zubehör; Alu, alu / Kunststoff, weiss
accessoire; aluminium, aluminium / plastique, blanc

L 2000, B 65, H 45



PROFILE CROSS-SECTION /
Profilquerschnitt / section de profil

98999 99002 99004
99001 99003 99005

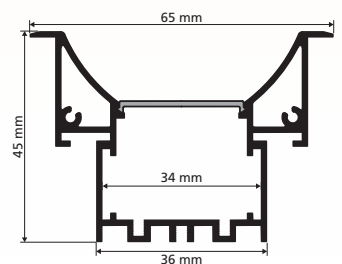



99006

99007

99008

INCLUDED IN DELIVERY /
im Lieferumfang enthalten /
inclus dans la livraison



99006
99007



99008
99009



99011
99012

99006 SURFACE PROFILE 6

accessory; aluminium, aluminium / plastic, white
Zubehör; Alu, alu / Kunststoff, weiss
accessoire; aluminium, aluminium / plastique, blanc

L 1000, B 35, H 45



99007 SURFACE PROFILE 6

accessory; aluminium, aluminium / plastic, white
Zubehör; Alu, alu / Kunststoff, weiss
accessoire; aluminium, aluminium / plastique, blanc

L 2000, B 35, H 45



99008 SURFACE PROFILE 6

accessory; aluminium, white / plastic, white
Zubehör; Alu, weiss / Kunststoff, weiss
accessoire; aluminium, blanc / plastique, blanc

L 1000, B 35, H 45



INSTALLATION PROFILES LARGE

incl. end caps



99009 SURFACE PROFILE 6

accessory; aluminium, white / plastic, white
Zubehör; Alu, weiss / Kunststoff, weiss
accessoire; aluminium, blanc / plastique, blanc

L 2000, B 35, H 45



99011 SURFACE PROFILE 6

accessory; aluminium, black / plastic, white
Zubehör; Alu, schwarz / Kunststoff, weiss
accessoire; aluminium, noir / plastique, blanc

L 1000, B 35, H 45



99012 SURFACE PROFILE 6

accessory; aluminium, black / plastic, white
Zubehör; Alu, schwarz / Kunststoff, weiss
accessoire; aluminium, noir / plastique, blanc

L 2000, B 35, H 45



PROFILE CROSS-SECTION / Profilquerschnitt / section de profil

99006 99008 99011
99007 99009 99012

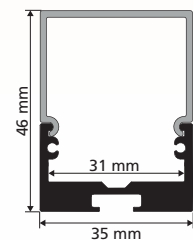

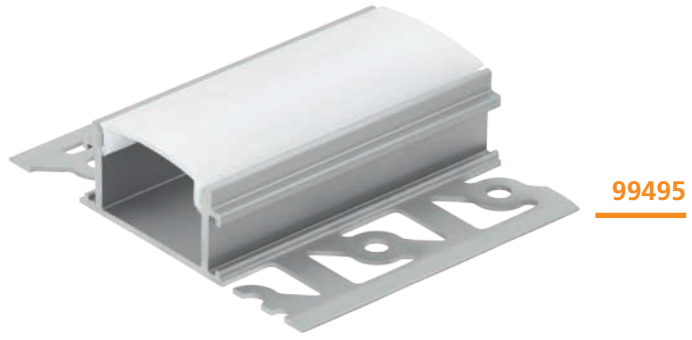

99495

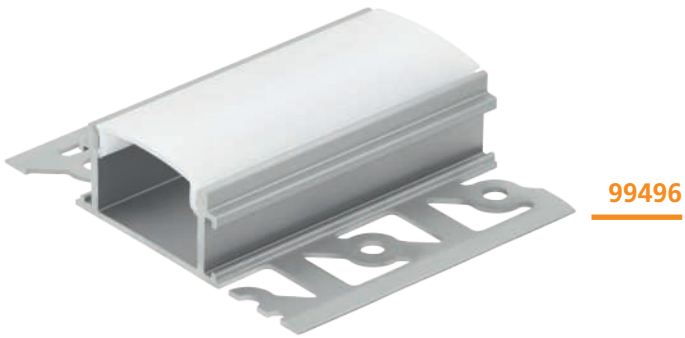

99496



99497

99495 RECESSED PROFILE 4

accessory; aluminium, aluminium / plastic, white
Zubehör; Alu, alu / Kunststoff, weiss
accessoire; aluminium, aluminium / plastique, blanc

L 1000, B 62, H 14



9 002759 994952

99496 RECESSED PROFILE 4

accessory; aluminium, aluminium / plastic, white
Zubehör; Alu, alu / Kunststoff, weiss
accessoire; aluminium, aluminium / plastique, blanc

L 2000, B 62, H 14



9 002759 994969

99497 RECESSED PROFILE 4

accessory; aluminium, black / plastic, white
Zubehör; Alu, schwarz / Kunststoff, weiss
accessoire; aluminium, noir / plastique, blanc

L 1000, B 62, H 14



9 002759 994976

TILE PROFILE



99498



99498 RECESSED PROFILE 4

accessory; aluminium, black / plastic, white
 Zubehör; Alu, schwarz / Kunststoff, weiss
 accessoire; aluminium, noir / plastique, blanc

L 2000, B 62, H 14



9 002759 994983

PROFILE CROSS-SECTION / Profilquerschnitt / section de profil

99495 99497
 99496 99498

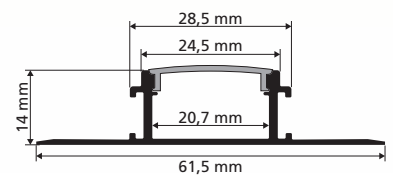

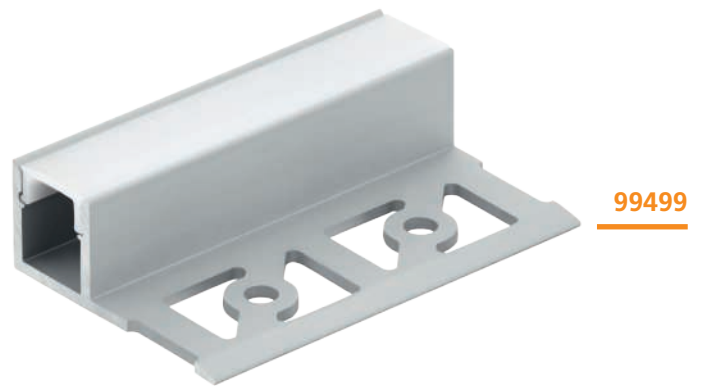

99502 RECESSED PROFILE 4

accessory; aluminium, black / plastic, white
Zubehör; Alu, schwarz / Kunststoff, weiss
accessoire; aluminium, noir / plastique, blanc

L 1000, B 13, H 13



99503 RECESSED PROFILE 4

accessory; aluminium, black / plastic, white
Zubehör; Alu, schwarz / Kunststoff, weiss
accessoire; aluminium, noir / plastique, blanc

L 2000, B 13, H 13



99499 RECESSED PROFILE 4

accessory; aluminium, aluminium / plastic, white
Zubehör; Alu, alu / Kunststoff, weiss
accessoire; aluminium, aluminium / plastique, blanc

L 1000, B 13, H 13



TILE PROFILE FINISHING BOARD

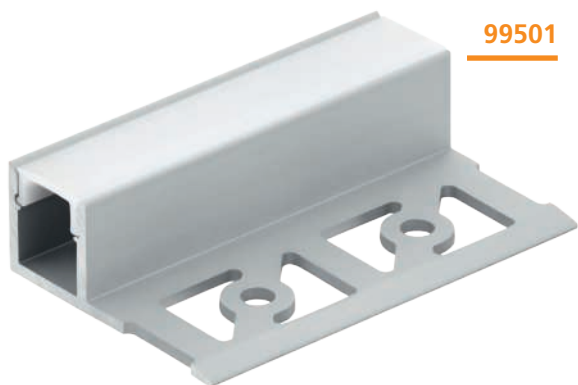

99501 RECESSED PROFILE 4

accessory; aluminium, aluminium / plastic, white
Zubehör; Alu, alu / Kunststoff, weiss
accessoire; aluminium, aluminium / plastique, blanc

L 2000, B 13, H 13



PROFILE CROSS-SECTION / Profilquerschnitt / section de profil

99499 99502
99501 99503

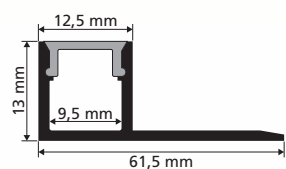

EGLO WORLDWIDE

EGLO WELTWEIT / EGLO DANS LE MONDE



 **AUSTRIA**
EGLO LEUCHTEN GMBH
Heiligkreuz 22
6136 Pill
T: +43 5242 6996 0 | F: +43 5242 6996 972
info-austria@eglo.com

 **AUSTRALIA**
EGLO LIGHTING AUSTRALIA
5/339 Archerfield Road
4077 Richlands | Queensland
T: +61 7 3375 1413 | F: +61 7 3375 1412
info@eglolighting.com.au

 **BELGIUM**
EGLO BELGIUM BV
Antwerpsesteenweg 247
2950 Kapellen
T: +32 3 250 60 80 | F: +32 3 219 80 67
info-belgium@eglo.com

 **BOSNIA AND HERZEGOVINA**
EGLO RASVJETA BH D.O.O.
Ormanica bb
76250 Gradacac
T: +387 35 86 85 00 | F: +387 35 82 44 41
info-Bosnia-Herzegovina@eglo.com

 **BULGARIA**
EGLO BULGARIA EOOD
Main Road Burgas-Sofia | 5th kilometer | Building EGLO
8000 Burgas
T: +359 56 960 403 | F: +359 56 53 05 95
info-bulgaria@eglo.com

 **CANADA**
EGLO CANADA INC.
20700 Route Transcanadienne
H9X 4B7 Baie D'Ufré, Quebec
T: +1 514 457 5483 | F: +1 514 457 5487
info-canada@eglo.com

 **CHILE**
EGLO CHILE ILUMINACIÓN LTDA.
Av. Américo Vespucio Norte 1930
Conchalí - Santiago de Chile
T: +562 2 595 2222
info-chile@eglo.com

 **CHINA**
DONGGUAN EGLO LIGHTING COMMERCIAL
CO LTD
No.1 | Shangqiao Industrial Rd Shangqiao, Dongcheng
Dongguancity, Guanzhouprovince
T: +86 769 2203 3866 | F: +86 769 2203 6866
info-china@eglo.com

 **COLOMBIA**
EGLO COLOMBIA ILUMINACIÓN SAS
Autopista Norte 800 Mts adelante del Peaje de los Andes
Costado Oriental Km 19 Lote 30
Bogotá - Chia
T: +57 (1) 744 2339
info-global@eglo.com

 **COSTA RICA**
EGLO COSTA RICA
Centro Comercial Calle Real local #8
Guachipilín de Escazú de la sucursal del BAC
San Jose 800 metros al norte | San Jose
T: +506-2289-4690 | F: +506-2100-6384
info-costarica@eglo.com

 **CROATIA**
EGLO RASVJETA D.O.O.
Jadranska avenija 9a
10000 Zagreb
T: +385 1 379 40 62 | F: +385 1 379 41 04
info-croatia@eglo.com

 **CZECH REPUBLIC**
EGLO CZ+SK s.r.o.
Náchodská 2479/63
193 00 Praha 9 Horní Pocernice
T: +420 281 924 163 | F: +420 281 925 205
info-czechrepublic@eglo.com

 **DENMARK**
EGLO DANMARK A/S
Agerbakken 20
8362 Hørning
T: +45 70 22 55 11 | F: +45 70 22 55 221
info-denmark@eglo.com

 **ESTONIA**
MOODNE VALGUSTUS AS
Rävalapst. 7
10143 Tallinn
T: +372 667 6670 | F: +372 631 3195
info-global@eglo.com

 **FINLAND**
EGLO FINLAND OY
Malmiraitti 17A
700 Helsinki
T: +358 20 7649 820 | F: +358 20 7649 821
info-finland@eglo.com

 **FRANCE**
EGLO FRANCE LUMINAIRE SARL
Z.A. Jeune Bois | 2 Rue de la Martinique
68274 Wittenheim
T: +33 3 89 62 50 45 | F: +33 389 6250 49
info-france@eglo.com

 **GERMANY**
EGLO LEUCHTEN HANDELS GMBH
Kleinbahnstr. 35
59759 Arnsberg
T: +49 2932 6269 0 | F: +49 2932 6269 39
info-germany@eglo.com

 **GREAT BRITAIN AND IRELAND**
EGLO UK LTD.
Unit 12 Cirrus Park, Lower Farm Road, Moulton Park
Industrial Estate, Northampton NN3 6UR
T: +44 1604 790 986 | F: +44 1604 670 282
info-greatbritain@eglo.com

**GREECE**

EGLO HELLAS A.E.

Sykias 2 and parodos dekeleias
13679 Acharnai
T: +30 21 0800 2363 | F: +30 210 240 07 29
info-greece@eglo.com

**HUNGARY - PRODUCTION AND LOGISTICS**

EGLO MAGYARORSZAG KFT.

Fő út. 155
3060 Paszto
T: + 36 32 560 050 | F: +36 32 560 040
info-hungary@eglo.com

**INDIA**

EGLO INDIA PRIVATE LIMITED

A-307, Ansal Chambers - 1, 3, Bhikaji Cama Place,
110066 Delhi
T: +91 85279 44288
info-india@eglo.com

**ITALY**

EGLO ITALIANA S.R.L.

Via Giotto, 4
31021 Mogliano Veneto (TV)
T: +39 041 45 66 232 / -245/ -251 |
F: +39 041 45 74 066 / -071
info-italy@eglo.com

**KAZAKHSTAN**

EGLO KAZAKHSTAN LLP

Al-Farabi Avenue 7, Office 72, 14rd floor, Block 4A,
Nurly-Tau Business Center
50059 Almaty
T: +7 727 293 25 20 | M: +7 701 031 00 00
info-kazakhstan@eglo.com

**KOSOVO**

EGLO KOSOVA LLC

Lugisht e qytetit pn
20000 Prizren
T: +383 44 216 687 | SHOP: +383 49 699 100
info-kosovo@eglo.com

**LATVIA**

MOODNE VALGUSTUS AS

Rävalapst.7
10143 Tallinn
T: +370 652 49923 | T: +372 667 6670
info-latvia@eglo.com

**LITHUANIA**

MOODNE VALGUSTUS AS

Rävalapst.7
10143 Tallinn
T: +370 652 49923 | T: +372 667 6671
info-latvia@eglo.com

**MAGYARORSZÁG – ÉRTÉKESÍTÉS**

EGLO LUX KFT.

Fő út. 143/A
2120 Dunakeszi
T: +36 27 341 353 | F: +36 27 341 409
info-hungary@eglo.com

**MALAYSIA**

EGLO ASIA SDN BHD

No. 13, Jalan Pelukis U1/46B, Temasya 18, Glenmarie,
40150 Shah Alam, Selangor Darul Ehsan
T: +6011 1050 2336 | F: +603 5567 9415
info-malaysia@eglo.com

**MEXICO**

EGLO MÉXICO ILUMINACIÓN S DE RL DE CV

Prolongación Avenida López Mateos Sur N°3561,
Fraccionamiento Los Gavilanes
C.P. 45645 Tlajomulco de Zúñiga | Jalisco
T: +52 33 3687 20 95
info-mexico@eglo.com

**MIDDLE EAST**

EGLO LIGHTING MIDDLE EAST FZE

P.O. BOX 262073, LOB6, OFFICE G18
Jebel Ali, Dubai, UAE
T: +97 148810080 | F: +97 148810081
gulf@eglo.com

**MOROCCO - EGLO AFRICA**

EGLO MAGHREB LUMINAIRES SARL

219 Bd Med Zerktoni. Suite: 67
20330 Casablanca
T: +212 522 98 80 25 / -05
info-global@eglo.com | info.africa@eglo.com

**THE NETHERLANDS**

EGLO VERLICHTING NEDERLAND B.V.

Innovatiepark 20
4906 AA Oosterhout (NBR)
T: +31 162 48 28 30
info.netherlands@eglo.com

**NORWAY**

MS Belysning AS

Heiaveien 4
1900 Fetstund
T: +47 63 888500 | F: +47 63 888501
info-norway@eglo.com

**PERU**

EGLO PERU S.A.C

Av Primavera 1419
Distrito de Santiago de Surco y Departamento de Lima
T: +51 902 763 635
info-peru@eglo.com

**POLAND**

EGLO POLSKA SP. Z O.O.

Ul. Dzwiekowa 2
02-857 Warszawa
T: +48 22 644 57 55 | F: +48 22 644 89 82
info-poland@eglo.com

**PORTUGAL**

EGLO PORTUGAL ILUMINAÇÃO, LDA

Rua Fonte Parada, 125
4595-434 Seroa-Paços de Ferreira
T: +351 255 890 000 | F: +351 255 892 346
info-portugal@eglo.com

**ROMANIA**

EGLO ROMANIA PRODEXIM SRL.

Str. Atomistilor nr. 1D
77125 Magurele - Ilfov
T: +40 314 250 902 | F: +40 314 250 899
info-romania@eglo.com

**RUSSIA**

EGLO LIGHTING LLC

Varshavskoe shosse 3 | Office 23
117105 Moscow
T: +7495 789 4311 | F: +7495 789 4312
info-russia@eglo.com

**SERBIA**

EGLO RASVETA DOO

Stefana Prvovenčanog 28
11000 Beograd
T: +381 11 3981 366 | F: +381 11 3981 389
info-serbia@eglo.com

**SLOVAKIA**

EGLO CZ+SK s.r.o

Náchodská 2479/63
193 00 Praha 9 Horní Počernice
T: +421 313 211 551 | F: +421 313 211 556
info-slovakia@eglo.com

**SLOVENIA**

EGLO RASVJETA D.O.O.

Jadranska avenija 9a
10000 Zagreb
T: +386 158 093 18
info-slovenia@eglo.com

**SPAIN**

EGLO ESPAÑA ILUMINACION S.L.

Avda. de Castilla 1 (Edf. Best Point) 2º-16A
28830 San Fernando de Henares, Madrid
T: +34 91 677 9044 | F: +34 91 677 0304
info-spain@eglo.com

**SWEDEN**

EGLO SVERIGE AB

Star Street 1
512 50 Svenljunga
T: +46 340 623 505 | F: +46 340 623 605
info-sweden@eglo.com

**SWITZERLAND**

EGLO SCHWEIZ AG

Seetalstraße 142
6032 Emmen
T: +41 41 268 69 59 | F: +41 41 268 69 58
info-switzerland@eglo.com

**TURKEY**

EGLO Aydınlatma ithalat ihracat Ltd. Şti.

Eyüp Sultan Mah. Sekmen Cad. No:18/2
34855 Sancaktepe / Istanbul Samandira
T: +90 216 311 09 -02 / -03 / -04 |
F: +90 216 311 09 / -05
info-turkey@eglo.com

**UKRAINE**

EGLO UKRAINE LTD

Vatslava Gavela boulevard, 6/7-A,
03124 Kyiv
T: +38 044 463 98 41 | F: +38 044 468 84 67
info-ukraina@eglo.com

**USA**

EGLO USA, INC.

3640 Royal South Parkway
30349 Atlanta, Georgia
T: +1 404 477 5601 | F: +1 404 393 7053
info-usa@eglo.com

HOW TO READ

ERKLÄRUNG

COMMENT LIRE

ARTICLE NUMBER & SERIES NAME
ARTIKELNUMMER & SERIENNAME
NUMÉRO D'ARTICLE & NOM DE LA SÉRIE

DIMENSIONS
DIMENSIONEN
DIMENSIONS

all dimensions in mm | alle Größen in mm | toutes dimensions en mm

L = length | Länge | longueur

B = width | Breite | largeur

H = height | Höhe | hauteur

Ø = diameter | Durchmesser | diamètre

A = projection length | Ausladung | amplitude

ET = installation depth | Einbautiefe | profondeur utile

Base = base dimensions | Sockelmaße | dimensions de base

Attention! The dimensions relate solely to the sizes of the luminaire. Any air spaces that would be relevant for a safe operating of the lamp were not considered.

Achtung! Die Größen beziehen sich nur auf die Abmessungen der Leuchte. Etwaige Lufträume, die für einen sicheren Betrieb der Leuchte notwendig sind, werden nicht berücksichtigt.

Attention! Les dimensions se réfèrent à la taille de la lampe seulement. Espacements éventuels, que seraient importants pour une opération de la lampe sans danger, n'ont pas été considérés.

PICTOGRAMMES
PIKTOGRAMME
PICTOGRAMMES

Technical details are represented as pictograms. An overview over all pictograms can be found on the next pages.

Technische Details werden als Piktogramme dargestellt. Eine Übersicht über alle Piktogramme finden Sie auf den nächsten Seiten.

Les détails techniques sont représentés sous forme de pictogrammes. Vous trouverez un aperçu de tous les pictogrammes dans les pages suivantes.

BUTTONS
BUTTONS
BOUTONS

Bulb included
Leuchtmittel inkludiert
ampoules inclus



Recessed Luminaire
Einbauleuchte
luminaire encastrable



Surface Luminaire
Aufbauleuchte
luminaire en saillie



95851
LED

95852
LED

95853
LED

95851 PINEDA
recessed light; plastic, white
Einbauleuchte; Kunststoff, weiss
luminaire encastrable; plastique, blanc

Ø 84, ET 40

LED
3x 4,9W 1470lm

WHITE

Ø 72

9 002759 958510

Ø 84

95852 PINEDA
recessed light; plastic, chrome
Einbauleuchte; Kunststoff, chrom
luminaire encastrable; plastique, chrome

Ø 84, ET 40

LED
3x 4,9W 1470lm

WHITE

Ø 72

9 002759 958527

Ø 84

95853 PINEDA
recessed light; plastic, satin nickel
Einbauleuchte; Kunststoff, nickel-matt
luminaire encastrable; plastique, nickel mat

Ø 84, ET 40

LED
3x 4,9W 1470lm

WHITE

Ø 72

9 002759 958534

Ø 84

RECESSED DOWNLIGHTS - HIGH VOLTAGE
154

DESCRIPTION
BESCHREIBUNG
DESCRIPTION

The product description is composed as follows:
luminaire type; enclosure material, enclosure colour / glass or shade material, glass or shade colour

Die Produktbeschreibung setzt sich wie folgt zusammen:
Leuchtenart; Gehäusematerial, Gehäusefarbe / Schirm- bzw. Glasmaterial, Schirm- bzw. Glasfarbe

La description du produit est composée comme suit:
type de luminaire; matériel de boîtier, couleur de boîtier / matériel de verre ou abat-jour, couleur de verre ou abat-jour

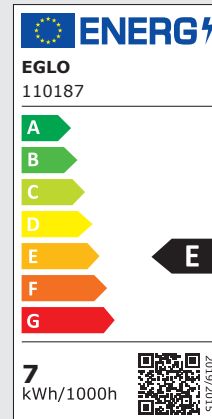

The new energy label must be indicated on all light sources with a luminous flux between 60 and 82,000 lumens and LED. This applies to lamps, LED modules and luminaires where the light source cannot be removed without destroying it.

Das neue Energielabel muss auf allen Lichtquellen mit einem Lichtstrom zwischen 60 und 82.000 Lumen und LED angegeben werden. Dies gilt für Lampen, LED-Module und Leuchten, bei denen die Lichtquelle nicht zerstörungsfrei entnommen werden kann.

Le nouveau label énergétique doit être indiqué sur toutes les sources lumineuses dont le flux lumineux est compris entre 60 et 82 000 lumens et sur les LED. Cela s'applique aux lampes, aux modules LED et aux luminaires dont la source lumineuse ne peut être retirée sans être détruite.

The information on the label includes: / Die Angaben auf dem Etikett beinhalten: / Les informations figurant sur l'étiquette sont les suivantes :

- › Name/Trademark
Name/Warenzeichen
Nom/marque de commerce
- › Model / Modell / Modèle
- › Energy label scale A-G / Energielabel-Skala A-G / Échelle d'étiquetage énergétique A-G
- › Energy consumption for 1,000 hours of use/
Energieverbrauch bei 1.000 Stunden Nutzung/
Consommation d'énergie pour 1 000 heures d'utilisation
- › Energy efficiency class of the product/
Energieeffizienzklasse des Produkts/
Classe d'efficacité énergétique du produit
- › QR Code to EPREL (Product Database of the European Product Registry for Energylabelling)/
QR Code zur EPREL (Produktdatenbank der European Product Registry for Energylabelling)/
Code QR pour EPREL (base de données des produits du registre européen des produits pour l'étiquetage énergétique)

The energy spectrum ranges from G to A.
Das Energiespektrum reicht von G bis A.
Le spectre énergétique va de G à A.



95857 PINEDA
recessed light; plastic, white
Einbauleuchte; Kunststoff, weiss
luminaire encastrable; plastique, blanc

95858 PINEDA
recessed light; plastic, chrome
Einbauleuchte; Kunststoff, chrom
luminaire encastrable; plastique, chrome

95859 PINEDA
recessed light; plastic, satin nickel
Einbauleuchte; Kunststoff, nickel-matt
luminaire encastrable; plastique, nickel mat

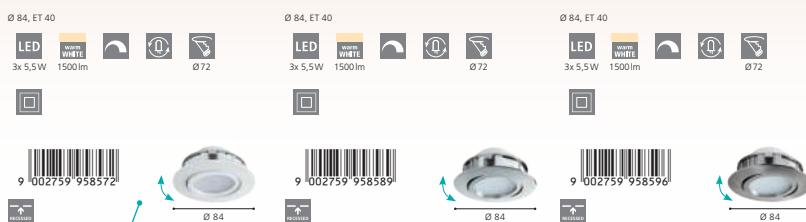

RECESSED DOWNLIGHTS - HIGH VOLTAGE
155

SKETCHES
SKIZZEN
CROQUIS

The sketches state the most meaningful dimensions. If a product is adjustable by will, a turquoise arrow marks this function and only the maximum dimensions are indicated.



















Die Bemaßung der Skizzen umfasst jeweils die aussagekräftigsten Größen. Bei verstellbaren Produkten kennzeichnet ein türkiser Pfeil diese Funktion und nur die maximalen Größen werden angegeben.

Les dimensions des croquis comprennent les plus représentatives. Si un produit est réglable au choix, une flèche turquoise affiche cette fonction et rien que les dimensions maximales sont indiquées.



























































LEGEND

PICTOGRAM
PIKTOGRAMME
PICTOGRAMME

SOCKETS FASSUNGEN DOUILLES

 LED	 G4	 G53
 2G7	 G5	 GU5,3 / MR16
 2G11	 G9	 GU10
 2GX13	 G10Q	 GX53
 E14	 G13	 GY6,35
 E27	 G23	 R7s

BULBS LEUCHTMITTEL AMPOULES

 E14 / C35	 E27 / A60 Halogen	 E27 / E140 Filament
 E14 / C35f	 E27 / R63 Halogen	 E27 / PS160 Filament
 E14 / D45	 E27 / A60 LED	 E27 / T30 Filament
 E14 / C35f LED	 E27 / A60 Filament	 E27 / T32 Filament
 E14 / D45 Halogen	 E27 / A65 LED	 G4 / T9
 E14 / C35 Halogen	 E27 / A75 Filament	 G4 / LT9
 E14 / T22	 E27 / G45 LED	 G4 / LT14
 E14 / C35 Filament	 E27 / G45 Filament	 G9
 E14 / C37 Filament	 E27 / G80 Filament	 G9 LED
 E14 / C35f Filament	 E27 / G95	 GU10
 E14 / C37f Filament	 E27 / G95 Filament	 GU10 LED
 E14 / P45 LED	 E27 / G125	 GU10 SMD LED
 E14 / P45 Filament	 E27 / G95 LED	 GX53 / LF75
 E14 / P50	 E27 / G200 Filament	LED LED board / LED Platine / LED bord
 E14 / ST48 Filament	 E27 / R63 LED	 MR16
 E14 / ST64 Filament	 E27 / ST48 Filament	 MR16 LED
 E14 / T20 LED	 E27 / ST64 Filament	 R7s / 78mm
 E27 / A60	 E27 / B80 Filament	 R7s / 118mm
 E27 / G90	 E27 / BR150 Filament	 R7s / 78mm LED
 E27 / QR63	 E27 / DP165 Filament	 R7s / 118mm LED

LIGHT COLOUR & LUMEN
LICHTFARBE & LUMEN
COULEUR LUMINEUX & LUMEN

The colours of the LED are represented as pictogrammes (see below), their luminous flux directly beneath. The luminous flux is quoted in lumen and describes the amount of light generated by the LED. The higher the value, the brighter is the lamp. Lumens are LED boards and are the light measurement value in bulbs.

Die Farben der LED werden als Piktogramm (siehe unten) dargestellt, deren Lichtstrom direkt darunter. Der Lichtstrom wird in Lumen gemessen und gibt die erzeugte Lichtmenge der LED an. Je höher der Wert, desto heller das Produkt. Lichtstromangaben (Lumen) sind Platinen- bzw. Leuchtmittelwerte.

Les couleurs de LED ont représentés sous forme de pictogrammes, leur flux lumineux directement en dessous. L'unité de flux lumineux est le lumen et il mesure la quantité de lumière générée par les LED. Plus la valeur est élevée, plus la lampe est lumineuse. Les lumens sont l'unité de mesure de l'intensité lumineuse des ampoules et des panneaux led intégrés.

	RGB RGB RGB
	RGB + white RGB + weiß RGB + blanc
	RGB + warmwhite RGB + warmweiß RGB + blanc chaud
	RGB + coldwhite RGB + kaltweiß RGB + blanc froid
	RGB + neutralwhite RGB + neutralweiß RGB + blanc neutrale

	RGB + tunable white RGB + tunable white RGB + tunable white
	tunable white tunable white tunable white
	warm white warmweiß blanc chaud
	cold white kaltweiß blanc froid
	neutral white neutralweiß blanc neutrale

SWITCHES & SENSORS
SCHALTER & SENSOREN
INTERRUPTEUR & CAPTEURS

	incl. cable & plug inkl. Kabel & Stecker câble & connecteur inclus
	internal dimmer eingebauter Dimmer variateur intégré
	button switch Druckknopf interrupteur de pression
	function switch Funktionsschalter interrupteur fonction
	rocker switch Wippschalter interrupteur à bascule
	pedal dimmer Trittdimmer variateur à pied

	pedal switch Trittschalter interrupteur à pied
	cable switch Kabelschalter interrupteur à câble
	incl. cable & plug transformer inkl. Kabel & Stecktransformator câble & transformateur à prise
	remote control Fernbedienung télécommande
	Day & Night Sensor Tag & Nacht Sensor sensor jour & nuit
	sensor Sensor sensor

	swedish plug Stecker Schweden connecteur swede
	"Touch me" ON/OFF "Touch me" EIN/AUS "Touch me" ON/OFF
	"Touch me" ON/OFF & dimm "Touch me" EIN/AUS & Dimmen "Touch me" ON/OFF & graduable
	pull switch Zugschalter interrupteur à bascule
	Timer - automatic on/off Zeitschaltuhr - automatisches Ein- & Ausschalten minuterie - peut être éteint et allumé automatiquement

FUNKTIONS & COMFORT
FUNKTIONEN & KOMFORT
FONCTIONS & COMFORT

	incl. battery inkl. Akku incl. pile
	incl. battery inkl. Batterie incl. pile
	battery specifications Batteriespezifikationen spécifications des piles
	beam angle Ausstrahlwinkel angle de rayonnement
	corner mount possible Eckmontage möglich montage en coin possible
	CRI Colour Rendering Index

	cutout (in mm) Ausschnitt (in mm) perçage du panneau (en mm)
	dimmable dimmbar mit externen Dimmer graduable
	not dimmable nicht dimmbar ne pas graduable
	Can be operated via control unit Bedienbar über Steuergerät Peut être commandé par une unité de contrôle
	replaceable LED austauschbare LED LED remplaçables
	loadable in kg belastbar in kg chargeable en kg

	packaging / delivery unit Verpackungs- / Liefereinheit unité d'emballage / de livraison
	shortable kürzbar réductible
	Voltage Volt Voltage
	Watt
	USB connection USB-Anschluss Connexion USB
	Qi-Charger

PROTECTION CLASS
SCHUTZKLASSE
CLASSE DE PROTECTION

The protection class indicates to what extent the lamp is protected against electric shock. All lamps in this catalogue are at least protected with the protection class 1 - a higher class is specified in the information box of the respective lamp.

Die Schutzklasse gibt an, inwiefern ein Produkt gegen einen elektrischen Schlag gesichert ist. Alle Leuchten in diesem Katalog sind mit mindestens Schutzklasse 1 gesichert, bei höheren Klassen wird das Symbol im Infokasten der Leuchte angegeben.

La classe de protection indique, dans quelle mesure la lampe est protégée contre les chocs électriques. Tous les lampes dans ce catalogue sont protégées au moins avec la classe 1 - une classe plus élevée est indiquée dans l'information de la lampe.

	protection class 1: protective earthing Schutzklasse 1: Schutzerdung classe de protection 1: prise de terre
--	---

	protection class 2: protective insulation Schutzklasse 2: Schutzisolation classe de protection 2: double isolation ou renforcée
--	---

	protection class 3: protective low voltage Schutzklasse 3: Schutzkleinspannung classe de protection 3: très basse tension de sécurité
--	---

PROTECTION RATING
SCHUTZGRAD
INDICE DE PROTECTION

The protection rating ensures the operational safety of luminaires. The first number specifies the extent of the protection against the ingress of foreign bodies; the second number identifies the humidity protection grade. All luminaires in this catalogue are at least protected with the rating IP20 - a higher rating is specified in the information box of the luminaire.

Der Schutzgrad gewährleistet die Betriebssicherheit von Leuchten. Die erste Ziffer des IP Grades beschreibt den Schutzzumfang gegen das Eindringen von Fremdkörpern, die zweite Ziffer informiert über den Grad des Feuchtigkeitsschutzes. Alle Leuchten in diesem Katalog sind mit mindestens Schutzgrad IP20 gesichert, bei höheren Graden wird das Symbol im Infokasten der Leuchte angegeben.

L'indice de protection assure la sécurité opérationnelle des luminaires. Le premier chiffre indique à quel point la protection est efficace contre l'insertion de corps étrangers; le second chiffre indique quant à lui le degré de protection par rapport à l'humidité. Tous les luminaires dans ce catalogue sont protégés au moins avec l'indice IP20 - un indice plus élevé est indiqué dans l'information d'article.

	IP33
	IP44

	IP54
--	------

	IP65
--	------

	IP67
--	------

REGISTER

ARTICLE NUMBER

ARTIKELNUMMER

NUMÉROS D'ARTICLE

NUMBER NUMMER NUMÉRO	PAGE SEITE PAGE	NUMBER NUMMER NUMÉRO	PAGE SEITE PAGE	NUMBER NUMMER NUMÉRO	PAGE SEITE PAGE	NUMBER NUMMER NUMÉRO	PAGE SEITE PAGE	NUMBER NUMMER NUMÉRO	PAGE SEITE PAGE	NUMBER NUMMER NUMÉRO	PAGE SEITE PAGE	NUMBER NUMMER NUMÉRO	PAGE SEITE PAGE
30891	267	900102	34	900578	289	94236	194	97262	268	98485	107	98854	45
30892	266	900103	40	900579	289	94237	194	97263	269	98521	182	98865	230
30893	267	900104	40	900581	254	94406	195	97264	270	98571	290	98866	230
30894	267	900105	38	900582	252	94407	195	97265	270	98572	290	98867	230
31683	196	900106	38	900583	253	94408	195	97266	269	98573	293	98868	231
31689	196	900107	38	900584	253	94496	278	97267	269	98574	293	98869	231
32811	103	900108	44	900585	253	94497	278	97268	271	98607	169	98871	231
32812	102	900109	44	900586	257	94499	278	97269	270	98609	172	98901	124
32813	103	900111	36	900587	257	94501	276	97271	268	98611	174	98902	124
32896	166	900112	36	900588	257	94502	276	97279	268	98637	190	98903	124
33107	108	900113	36	900589	255	94503	277	97501	106	98639	190	98904	125
33108	108	900114	42	900591	255	94504	276	97502	106	98801	81	98905	125
33199	58	900115	42	900592	255	95359	197	97503	106	98802	81	98911	300
61355	112	900181	238	900593	256	95817	160	97593	184	98803	81	98912	300
61358	112	900182	238	900594	256	95818	160	97594	184	98804	90	98913	300
61359	113	900183	247	900595	256	95819	160	97927	294	98805	91	98914	301
61361	113	900184	247	900637	260	95821	162	97928	294	98806	91	98915	301
61489	112	900336	18	900638	258	95822	162	98025	103	98807	91	98916	301
900044	30	900337	18	900639	259	95823	163	98129	102	98808	82	98917	302
900045	30	900338	19	900641	259	95843	158	98201	60	98809	82	98918	302
900046	30	900339	18	900643	264	95844	158	98203	60	98811	84	98919	302
900047	31	900451	199	900644	264	95846	158	98205	61	98812	84	98921	303
900048	31	900452	200	900646	262	95848	152	98206	61	98813	84	98922	303
900049	32	900453	200	900647	262	95851	154	98207	58	98814	86	98923	303
900051	32	900454	199	900649	263	95852	154	98208	58	98815	86	98924	304
900052	32	900455	201	900651	263	95853	154	98209	59	98816	86	98925	304
900053	33	900456	201	900653	260	95855	153	98212	63	98817	87	98926	304
900054	24	900481	20	900654	258	95856	153	98238	176	98818	87	98927	305
900055	24	900482	20	900703	116	95857	155	98241	177	98819	87	98928	305
900056	24	900483	20	900704	116	95858	155	98243	169	98821	80	98929	305
900057	28	900484	21	900705	117	95859	155	98244	169	98822	80	98931	306
900058	28	900485	21	900706	117	95887	164	98292	63	98823	80	98932	306
900059	28	900486	22	900707	117	95888	164	98293	63	98824	88	98933	306
900061	29	900487	22	900708	119	95889	164	98297	60	98825	88	98934	308
900062	29	900558	130	900743	161	95932	165	98301	172	98826	88	98935	308
900086	46	900559	130	900744	163	96151	111	98302	174	98827	89	98936	308
900087	47	900561	130	900747	173	96152	110	98303	172	98828	89	98937	307
900088	46	900568	122	900748	157	96153	110	98304	174	98829	89	98938	307
900089	46	900569	122	900749	157	96154	110	98305	173	98842	35	98939	307
900091	48	900571	128	900751	193	96791	280	98306	175	98843	40	98941	310
900092	49	900572	128	900752	193	96792	280	98307	173	98844	37	98942	310
900093	48	900573	128	900753	191	96794	280	98308	175	98845	42	98943	310
900094	48	900574	288	900754	191	96901	178	98418	104	98846	39	98944	311
900095	33	900575	288	900815	198	96902	178	98419	104	98847	44	98945	312
900099	34	900576	288	900816	199	97029	295	98472	170	98849	41	98946	312
900101	34	900577	289	94235	194	97079	186	98474	170	98852	43	98947	312

NUMBER NUMMER NUMÉRO	PAGE SEITE PAGE	NUMBER NUMMER NUMÉRO	PAGE SEITE PAGE	NUMBER NUMMER NUMÉRO	PAGE SEITE PAGE	NUMBER NUMMER NUMÉRO	PAGE SEITE PAGE	NUMBER NUMMER NUMÉRO	PAGE SEITE PAGE	NUMBER NUMMER NUMÉRO	PAGE SEITE PAGE
98948	313	99003	332	99179	218	99242	245	99473	137	99744	73
98949	314	99004	333	99181	218	99243	246	99474	138	99745	72
98951	314	99005	332	99183	219	99244	246	99475	138	99746	73
98952	314	99006	334	99184	219	99245	246	99476	138	99747	73
98953	315	99007	334	99185	219	99246	248	99493	177	99749	77
98954	316	99008	334	99187	221	99247	248	99494	177	99751	69
98955	316	99009	335	99188	221	99248	248	99495	336	99753	74
98956	316	99011	335	99189	221	99252	249	99496	336	99754	75
98957	317	99012	335	99191	223	99253	249	99497	336	99755	77
98958	318	99038	132	99192	223	99254	249	99498	337	99756	69
98959	318	99039	132	99193	223	99255	250	99499	338	99757	74
98961	318	99099	15	99202	224	99256	250	99501	339	99758	75
98962	319	99131	204	99203	224	99257	250	99502	338	99759	75
98963	320	99132	204	99204	226	99258	252	99503	338	99761	74
98964	320	99133	204	99205	226	99259	252	99548	26	99762	68
98965	320	99134	205	99206	224	99263	254	99549	26	99763	68
98966	321	99135	205	99207	225	99264	254	99639	26	99764	76
98967	322	99136	206	99208	226	99265	258	99643	179	99765	76
98968	322	99137	206	99209	227	99266	259	99644	179	99833	120
98971	322	99138	206	99211	228	99267	260	99669	17	99834	121
98972	323	99139	207	99212	228	99268	262	99671	17	99835	121
98974	323	99141	207	99213	228	99269	263	99672	17	99836	121
98975	323	99142	208	99214	229	99271	264	99684	50	99841	133
98977	324	99143	208	99215	235	99281	282	99685	51	99842	133
98978	324	99144	208	99216	235	99282	282	99686	50	99843	118
98979	324	99145	209	99217	235	99283	283	99687	50	99844	118
98981	325	99146	209	99218	236	99284	283	99716	290	99845	118
98982	325	99147	210	99219	236	99337	274	99717	291	99846	119
98983	325	99148	210	99221	236	99338	274	99718	291		
98984	326	99149	210	99222	237	99421	140	99719	291		
98985	326	99151	211	99223	237	99422	140	99721	292		
98986	326	99152	212	99224	237	99423	141	99722	292		
98987	327	99153	212	99225	240	99424	141	99723	292		
98988	327	99154	212	99226	240	99425	142	99724	294		
98989	327	99155	213	99227	240	99426	142	99726	274		
98991	328	99156	214	99228	241	99427	143	99727	275		
98992	328	99157	214	99229	241	99428	143	99728	100		
98993	328	99158	214	99232	241	99431	144	99729	100		
98994	329	99159	215	99233	242	99432	144	99734	70		
98995	329	99162	216	99234	242	99433	145	99735	70		
98996	329	99163	216	99235	242	99434	145	99736	71		
98997	330	99164	216	99236	244	99435	136	99737	70		
98998	330	99167	217	99237	244	99436	136	99738	71		
98999	333	99168	217	99238	244	99437	136	99739	71		
99001	333	99169	217	99239	245	99471	137	99742	72		
99002	332	99178	218	99241	245	99472	137	99743	72		

REGISTER

SERIES NAMES
SERIENNAMEN
NOME DE PRODUITS

NAME NAME NOM	PAGE SEITE PAGE	NAME NAME NOM	PAGE SEITE PAGE	NAME NAME NOM	PAGE SEITE PAGE
ACCESS REMOTE	58	PINEDA 1	165	TB CORNER CONNECT	71, 73
AREITIO	190	POLASSO	276-278	TB CORTADERAS	75
BORDONARA	128	RECESSED PROFILE 1	324-326	TB CORTENOVA	74-75
CAROSSO	198-201	RECESSED PROFILE 2	327-329	TB MIDDLE FEEDER	71, 73
CHANGO	186	RECESSED PROFILE 3	332-333	TB NEWTOWN	74
COB Stripe	288-289	RECESSED PROFILE 4	336-339	TB SERAS	77
CONNECT Z	15	RONZANO 1	182	TB SET	68
CORNER PROFILE 1	310-315	ROVITO-Z	46-49	TB SPOTLIGHT	69
CORNER PROFILE 2	316-321	SALABATE	176-177	TB TRACK L	70, 72
CRESPILLO	274-275	SALICETO	169-175	TB TRACK S	70, 72
FERREROS	280	SALICETO-Z	17	TEDO	196
FIOBBO	184	SALOBRENA 1	102-103, 110-113	TEDO 1	197
FLEXIBLE STRIPE	290-294	SALOBRENA-A	60-61	TELIBELA-Z	18-19
FUEVA 1	268-271	SALOBRENA-F	140-145	TP BLIND COVER L	89
FUEVA 5	204-219, 221, 223-229, 235-238, 240-242, 244-250, 252-260, 262-264, 266-267	SALOBRENA-M	104	TP BLIND COVER S	88
FUEVA FLEX	230-231	SALOBRENA-RGBW	108	TP CANOPY	91
FUEVA-A	63	SALOBRENA-Z	30-33	TP CUBE CONNECTOR	81
FUEVA-Z	34-45	SARSINA	106-107	TP DOWNLIGHT	86
GRIMASOLA	282-283	SARSINA-A	58-59	TP LIGHT INSERT L	82
HERRORA-Z	26	SARTIANO	166	TP LIGHT INSERT S	82
LAZARAS	133	SAVATARILA	132	TP PENDANT LIGHT	84
LED STRIPE-Z	50-51	SURFACE PROFILE 1	300-302	TP SPOTLIGHT	87
LED STRIPES-FLEX	294	SURFACE PROFILE 2	303-305	TP SUSPENSION	90
MARMORATA	130	SURFACE PROFILE 3	306-308	TP TRACK	80
MECINOS	179	SURFACE PROFILE 4	322-323	TRUPIANA	122
PADROGIANO-Z	20-22	SURFACE PROFILE 5	330	TURCONA	124-125
PENETO	191, 193-195	SURFACE PROFILE 6	334-335	TURCONA-B	116-119
PIDIO	295	TB ADAPTER	71, 73	TURCONA-CCT	120-121
PIGLIONASSO	136-138	TB BUZZ	76	TURCONA-Z	24, 28-29
PINEDA	152-164	TB CASIBARE	74	URTEBIETA	100
		TB CONNECTOR	70, 72	ZARATE	178



NOTES

NOTIZEN
NOTES



A large grid of empty cells, likely a legend or register table. The grid consists of 20 columns and 30 rows of small, empty rectangular cells. The lines are thin and light gray.

All previous catalogues and price lists are no longer valid with the issue of this catalogue. Errors, misprints, model and price changes and technical modifications are reserved. We deliver based on our terms of delivery and payment. Our products comply with the European light norm EN60598. Products with the ENEC test mark are conforming to the guide line 2006/95/EG. Products with additional safety remarks (e.g protection class, IP) are identified within the product family with the relevant symbol and number. The content of this catalogue is protected under copyright law for EGLO Leuchten GmbH. All rights reserved. Our specific written consent must be obtained before using any illustrations and texts. The pictures are 4C prints and may differ from the original.

The product pictures and ambiances in this catalogue can deviate from reality, and they do not necessarily concur with the usual application of the product. EGLO does not assume liability for the correctness, completeness or the application depiction of the products and/or the product information.

Design, layout and composition: EGLO Leuchten GmbH, A-6136 Pill - AUSTRIA

Print: Samson Druck GmbH, 5581 St. Margarethen - AUSTRIA

Pictures: EGLO, Adobe Stock, istockphoto.com

Mit diesem Katalog verlieren alle vorhergehenden Kataloge und Preislisten ihre Gültigkeit. Irrtümer, Druckfehler, Modell- und Preisänderungen sowie technische Änderungen vorbehalten. Wir liefern zu unseren Liefer- und Zahlungsbedingungen. Unsere Produkte entsprechen der europäischen Leuchtnorm EN 60598. Produkte mit dem ENEC Prüfzeichen sind konform mit der Richtlinie 2006/95/EG. Produkte mit weiteren Sicherheitshinweisen (zB. Schutzklasse, IP) sind mit Symbol und Zahl bei der Produktfamilie ausgezeichnet. Der Inhalt dieses Kataloges ist für die EGLO Leuchten GmbH urheberrechtlich geschützt. Alle Rechte sind vorbehalten. Bilder und Texte dürfen nicht ohne vorherige ausdrückliche, schriftliche Genehmigung verwendet werden. Die Abbildungen sind 4C Drucke und können vom Original abweichen.

Die Katalogbilder und die gezeigten Darstellungen der Produkte können von der Wirklichkeit abweichen und nicht den üblichen Produktanwendungen entsprechen. EGLO übernimmt keine Haftung für die Richtigkeit, Vollständigkeit und Anwendungsdarstellung der Produkte und Produktinformationen.

Gestaltung, Layout und Satz: EGLO Leuchten GmbH, A-6136 Pill - AUSTRIA

Druck: Samson Druck GmbH, 5581 St. Margarethen - AUSTRIA

Bilder: EGLO, Adobe Stock, istockphoto.com

Le présent catalogue remplace tous les catalogues et tarifs précédents. Sous réserve d'erreurs, de fautes d'impression, de modification des modèles et de changement de prix et de technique. Nous livrons sur la base de nos conditions de livraison et de paiement. Nos produits sont conformes aux normes européennes EN 60598 et portent le marquage CE. Les produits portant la marque ENEC sont conformes à la Directive 2006/95/EG. Les produits portant d'autres indications de sécurité (par exemple classe de protection, IP) sont identifiés par le symbole et le nombre correspondants dans la famille de produits.

Le contenu du présent catalogue est protégé pour la société EGLO Leuchten GmbH par un copyright. Tous droits réservés. Toute reproduction d'images et du texte est interdite sans autorisation explicite par écrit préalable. Les images sont imprimées en 4C et peuvent différer de l'original.

Les images des produits et les ambiances dans le catalogue peuvent dévier de la réalité et ne sont pas nécessairement en ligne avec l'usage habituel du produit. EGLO n'engage pas sa responsabilité sur la justesse des images et sur les informations relatives à l'usage pouvant être fait des produits.

Conception, maquette et composition: EGLO Leuchten GmbH, A-6136 Pill - AUSTRIA

Presse: Samson Druck GmbH, 5581 St. Margarethen - AUSTRIA

Images: EGLO, Adobe Stock, istockphoto.com

06-2022



EGLO
my light | my style

EGLO Leuchten GmbH
Heiligkreuz 22
A-6136 Pill
Austria
Tel. +43 (0) 5242 6996
Fax +43 (0) 5242 6996-972
info@eglo.com
www.eglo.com

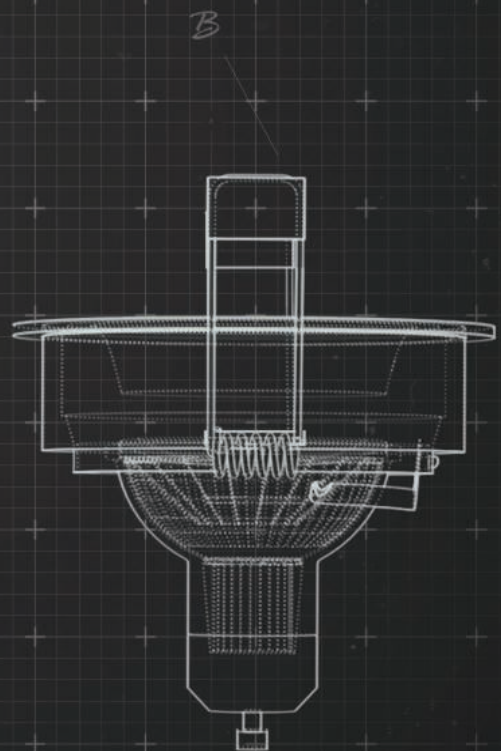
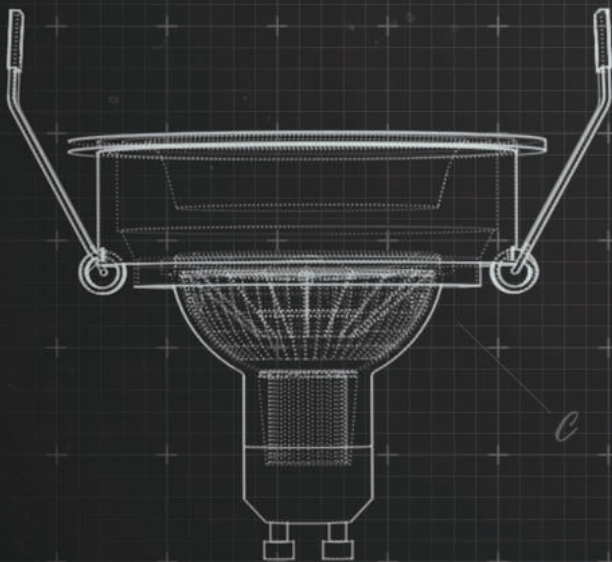
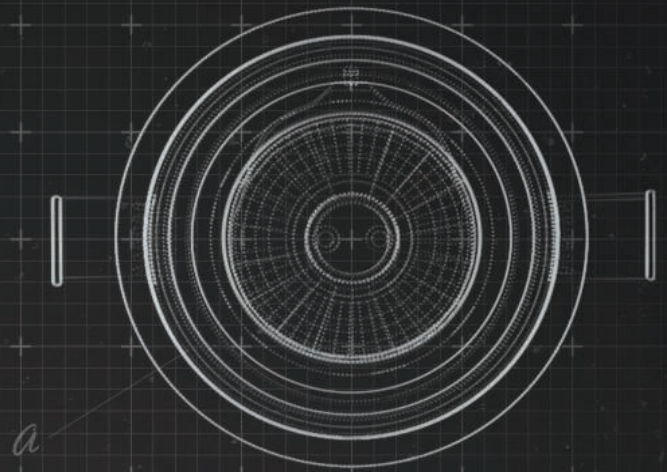

my light | my style

