



900435



900443



900435 VALCASOTTO 1

ceiling light; steel, wood, black, brown
 Deckenleuchte; Stahl, Holz, schwarz, braun
 plafonnier; acier, bois, noir, marron

L 370, B 370, H 100

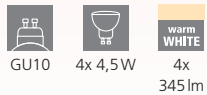

900443 TARRAFO

ceiling light; steel, wood, black, brown
 Deckenleuchte; Stahl, Holz, schwarz, braun
 plafonnier; acier, bois, noir, marron

L 640, B 150, H 155

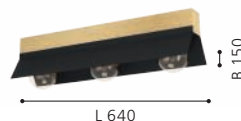
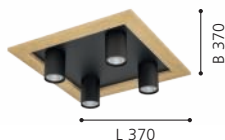



99667



900188

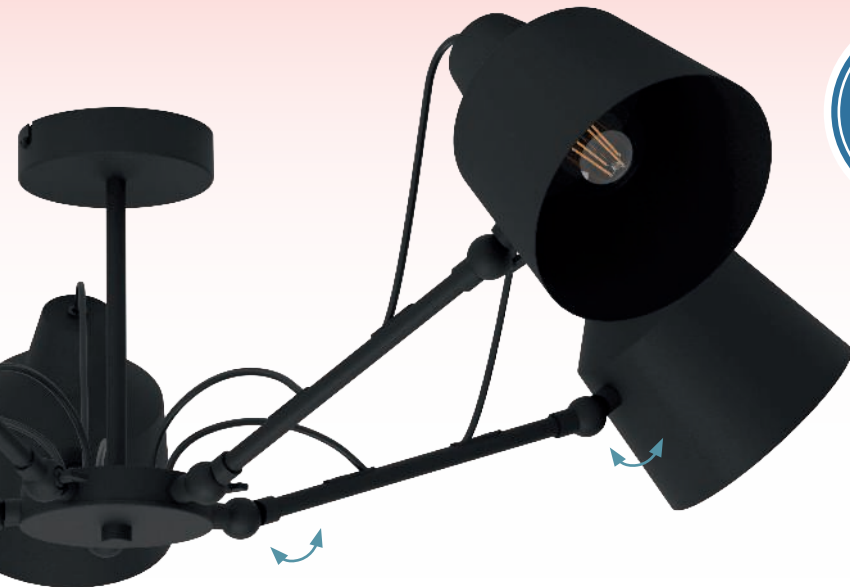

DESIGN
HIGHLIGHT
DETAIL

99667 BASURTU

ceiling light; steel, black
Deckenleuchte; Stahl, schwarz
plafonnier; acier, noir

H 270, Ø 1050



E27



5x 40W



9 002759 996673

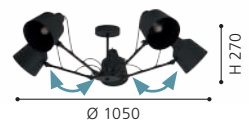



900157



900614

900188 LORETO

ceiling light; steel, black, white
Deckenleuchte; Stahl, schwarz, weiss
plafonnier; acier, noir, blanc

H 355, Ø 1145



E27 3x 25W



9 008606 235629

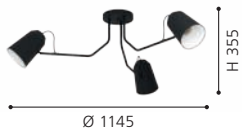

900157 LORETO

wall light; steel, black, white
Wandleuchte; Stahl, schwarz, weiss
applique; acier, noir, blanc

L 670, B 140, H 365



E27 1x 40W



9 008606 235766



900614 LORETO 1

wall light; steel, black, white
Wandleuchte; Stahl, schwarz, weiss
applique; acier, noir, blanc

L 140, H 350, A 1030



E27 1x 28W



9 008606 245116

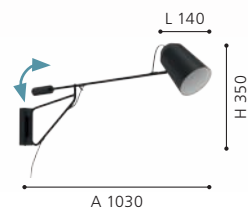



900361





900185



98514



98514

900361 MARIEL

ceiling light; steel, wood, light grey, brown
Deckenleuchte; Stahl, Holz, hellgrau, braun
plafonnier; acier, bois, gris clair, marron

L 910, B 190, H 255



E27



3x 40W

900185 FILAGO

ceiling light; steel, wood, black, brown / glass, black-grey-transparent
Deckenleuchte; Stahl, Holz, schwarz, braun / Glas, schwarz-grau-transparent
plafonnier; acier, bois, noir, marron / verre, noir-gris-transparent

L 880, B 145, H 250



E27



4x 40W

98514 MAROJALES

ceiling light; steel, black / glass vaporized, black-transparent
Deckenleuchte; Stahl, schwarz / Glas bedampft, schwarz-transparent
plafonnier; acier, noir / verre vaporisé, noir transparent

L 555, B 180, H 280



E27



2x 28W



9 008606 239108



L 910



9 008606 235322

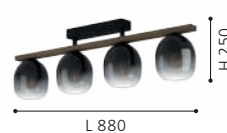

L 880



9 002759 985141



L 555



30933

LED



30931

LED

30933 CABO

ceiling light; stainless steel, chrome / satin glass, white, clear
Deckenleuchte; Edelstahl, chrom / Glas satiniert, weiss, klar
plafonnier; acier inoxydable, chrome / verre satiné, blanc, transparent

H 70, Ø 350



GU10



5x 2,8W



5x
warm
WHITE
250lm



9 002759 309336



30931 CABO

ceiling light; stainless steel, chrome / satin glass, white, clear
Deckenleuchte; Edelstahl, chrom / Glas satiniert, weiss, klar
plafonnier; acier inoxydable, chrome / verre satiné, blanc, transparent

L 290, B 290, H 70



GU10



4x 2,8W



4x
warm
WHITE
250lm



9 002759 309312



92727 CONDRA 1

ceiling light; steel, chrome / satin glass, white
Deckenleuchte; Stahl, chrom / Glas satiniert, weiss
plafonnier; acier, chrome / verre satiné, blanc

L 470, B 470, H 300



G9



8x 18W



9 002759 927271

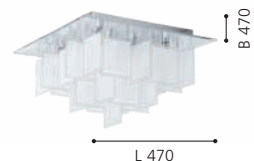



92727



95285



95284



CLEMENTE

95285 CLEMENTE

ceiling light; steel, chrome / crystal, clear
Deckenleuchte; Stahl, chrom / Kristall, klar
plafonnier; acier, chrome / cristal, transparent

H 205, Ø 450



E27 3x 60W

95284 CLEMENTE

ceiling light; steel, chrome / crystal, clear
Deckenleuchte; Stahl, chrom / Kristall, klar
plafonnier; acier, chrome / cristal, transparent

H 200, Ø 350



E27 2x 60W

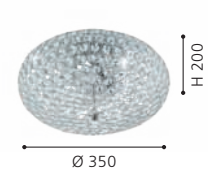
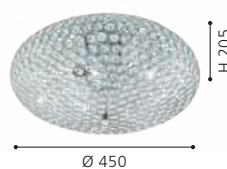



95639



99356



32025



99356 ACOLLA 1

wall / ceiling light; steel, black / glass with crystals, white, clear
Wand- / Deckenleuchte; Stahl, schwarz / Glas mit Kristallen, weiss, klar
applique / plafonnier; acier, noir / verre avec cristaux, blanc, transparent

H 85, Ø 290



11W 1300lm

95639 ACOLLA

wall / ceiling light; steel, chrome / glass with crystals, white, clear
Wand- / Deckenleuchte; Stahl, chrom / Glas mit Kristallen, weiss, klar
applique / plafonnier; acier, chrome / verre avec cristaux, blanc, transparent

H 85, Ø 290



11W 950lm

32025 CARDITO

ceiling light; steel, chrome / glass, crystal, clear
Deckenleuchte; Stahl, chrom / Glas, Kristall, klar
plafonnier; acier, chrome / verre, cristal, transparent

L 320, B 320, H 55



16W 2500lm



9 002759 993566



9 002759 956394



9 002759 320256

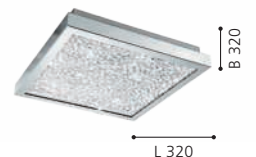



99324

LED



99325

LED



99328

LED

99324 FRADELO 1

wall / ceiling light; steel, black / plastic, crystal, black, clear
Wand- / Deckenleuchte; Stahl, schwarz / Kunststoff, Kristall, schwarz, klar
applique / plafonnier; acier, noir / plastique, cristal, noir, transparent

L 140, B 140, H 60



1x 3,2W 400lm

99325 FRADELO 1

wall / ceiling light; steel, black / plastic, crystal, black, clear
Wand- / Deckenleuchte; Stahl, schwarz / Kunststoff, Kristall, schwarz, klar
applique / plafonnier; acier, noir / plastique, cristal, noir, transparent

L 460, B 140, H 60



3x 3,5W 1200lm

99328 FRADELO 1

ceiling light; steel, black / plastic, crystal, black, clear
Deckenleuchte; Stahl, schwarz / Kunststoff, Kristall, schwarz, klar
plafonnier; acier, noir / plastique, cristal, noir, transparent

L 520, B 520, H 95



46,5W 5500lm



9 002759 993245

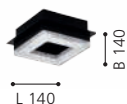

9 002759 993252



9 002759 993283

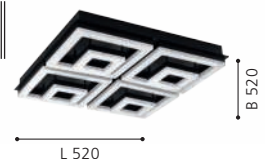



99327

LED



99326

LED



99327 FRADELO 1

ceiling light; steel, black / plastic, crystal, black, clear
 Deckenleuchte; Stahl, schwarz / Kunststoff, Kristall, schwarz, klar
 plafonnier; acier, noir / plastique, cristal, noir, transparent

L 260, B 260, H 85



4x 2W 920lm 1x 3,5W 400lm



9 002759 993276

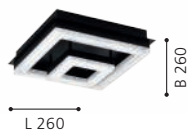

99326 FRADELO 1

wall / ceiling light; steel, black / plastic, crystal, black, clear
 Wand- / Deckenleuchte; Stahl, schwarz / Kunststoff, Kristall, schwarz, klar
 applique / plafonnier; acier, noir / plastique, cristal, noir, transparent

L 280, B 280, H 60



4x 3,5W 1600lm



9 002759 993269

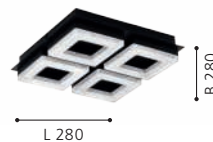

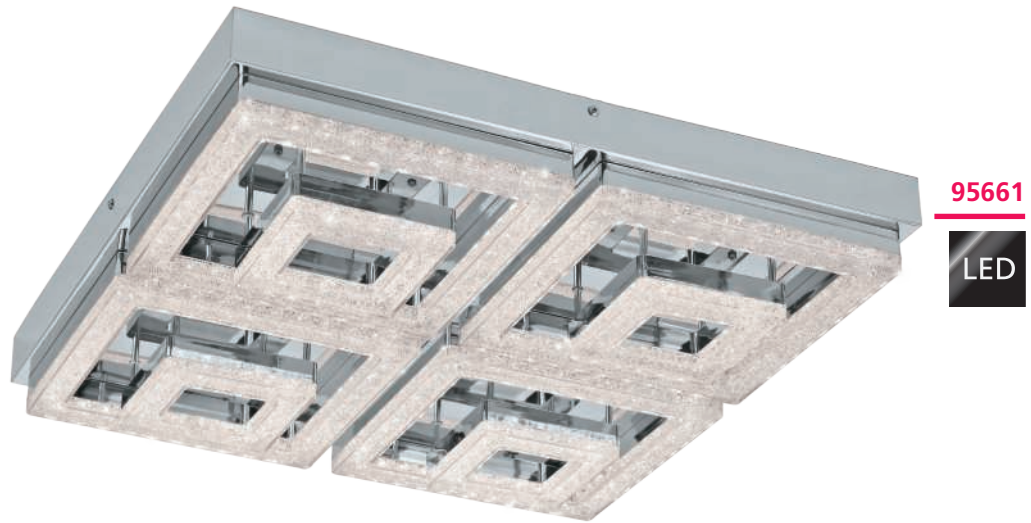
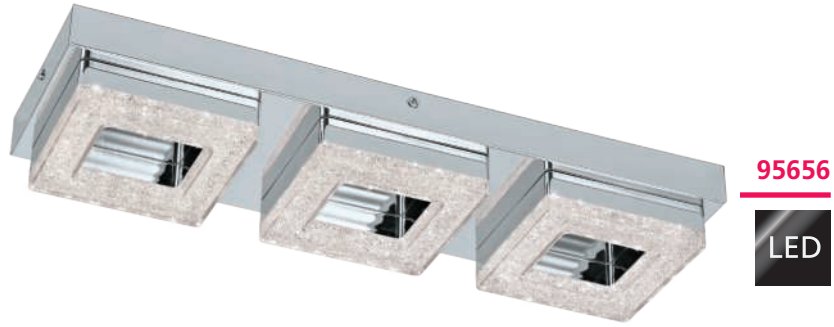

95655 FRADELO

wall / ceiling light; steel, chrome / plastic, crystal, chrome, clear
 Wand- / Deckenleuchte; Stahl, chrom / Kunststoff, Kristall, chrom, klar
 applique / plafonnier; acier, chrome / plastique, cristal, chrome, transparent

L 140, B 140, H 60



1x 3,2W 400lm

95656 FRADELO

wall / ceiling light; steel, chrome / plastic, crystal, chrome, clear
 Wand- / Deckenleuchte; Stahl, chrom / Kunststoff, Kristall, chrom, klar
 applique / plafonnier; acier, chrome / plastique, cristal, chrome, transparent

L 460, B 140, H 60



3x 3,5W 1200lm

95661 FRADELO

ceiling light; steel, chrome / plastic, crystal, chrome, clear
 Deckenleuchte; Stahl, chrom / Kunststoff, Kristall, chrom, klar
 plafonnier; acier, chrome / plastique, cristal, chrome, transparent

L 520, B 520, H 95



46,5W 5500lm



9 002759 956554

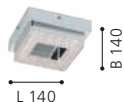

9 002759 956561

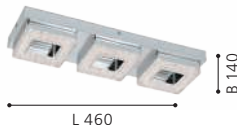

9 002759 956615





95657

LED

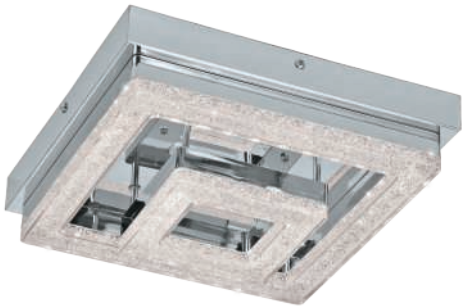

95659

LED



95658

LED



95657 FRADELO

wall / ceiling light; steel, chrome / plastic, crystal, chrome, clear
Wand- / Deckenleuchte; Stahl, chrom / Kunststoff, Kristall, chrom, klar
applique / plafonnier; acier, chrome / plastique, cristal, chrome, transparent

L 280, B 280, H 60



4x 3,5W 1600lm



9 002759 956578

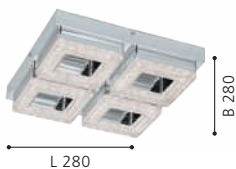

95659 FRADELO

ceiling light; steel, chrome / plastic, crystal, chrome, clear
Deckenleuchte; Stahl, chrom / Kunststoff, Kristall, chrom, klar
plafonnier; acier, chrome / plastique, cristal, chrome, transparent

L 260, B 260, H 85



4x 2W 920lm 1x 3,5W 400lm



9 002759 956592

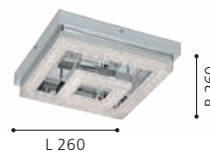

95658 FRADELO

wall / ceiling light; steel, chrome / plastic, crystal, chrome, clear
Wand- / Deckenleuchte; Stahl, chrom / Kunststoff, Kristall, chrom, klar
applique / plafonnier; acier, chrome / plastique, cristal, chrome, transparent

L 440, B 440, H 70



9x 3,8W 3780lm



9 002759 956585





95664

LED



95662

LED



95664 FRADELO

wall / ceiling light; steel, chrome / plastic, crystal, chrome, clear
Wand- / Deckenleuchte; Stahl, chrom / Kunststoff, Kristall, chrom, klar
applique / plafonnier; acier, chrome / plastique, cristal, chrome, transparent

L 280, B 280, H 60



4x 3,5W 1600lm

95662 FRADELO

wall / ceiling light; steel, chrome / plastic, crystal, chrome, clear
Wand- / Deckenleuchte; Stahl, chrom / Kunststoff, Kristall, chrom, klar
applique / plafonnier; acier, chrome / plastique, cristal, chrome, transparent

L 140, B 140, H 60



1x 3,2W 400lm



9 002759 956646



9 002759 956622





95689

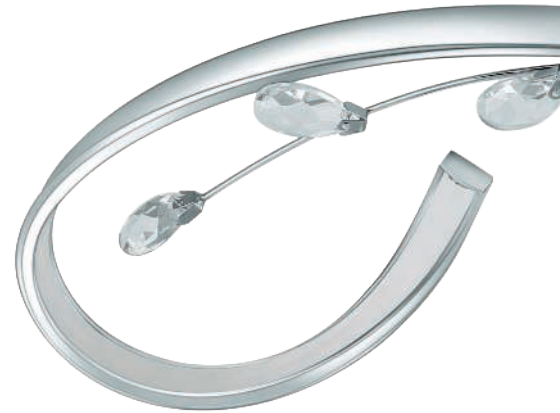

VALLEMARE

These luminaires come with high quality glass crystals.
 Diese Leuchten sind mit hochwertigen Glaskristallen ausgestattet.
 Ces luminaires viennent avec des cristaux de verre de haute qualité.

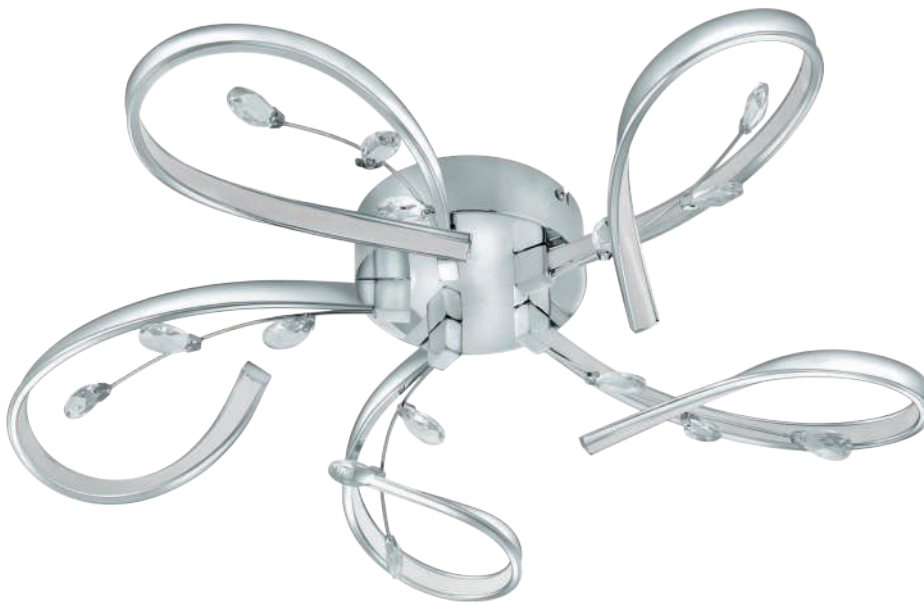

97487



95689 SORRENTA 1

wall / ceiling light; steel, white / glass with crystals, white, clear
 Wand- / Deckenleuchte; Stahl, weiss / Glas mit Kristallen, weiss, klar
 applique / plafonnier; acier, blanc / verre avec cristaux, blanc, transparent

H 95, Ø 315



97487 VALLEMARE

wall / ceiling light; aluminium, steel, chrome / plastic, crystal, white, clear
 Wand- / Deckenleuchte; Alu, Stahl, chrom / Kunststoff, Kristall, weiss, klar
 applique / plafonnier; aluminium, acier, chrome / plastique, cristal, blanc, transparent
 H 125, Ø 650



9 002759 956899

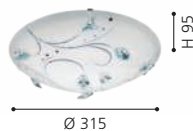

9 002759 974879

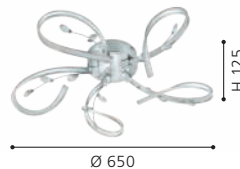

SORRENTA 1

This luminaire comes with high quality glass crystals.
 Diese Leuchte ist mit hochwertigen Glaskristallen ausgestattet.
 Cette luminaire vient avec des cristaux de verre de haute qualité.



98527

LED

incl./inkl./inclus



 TUNABLE WHITE	 STEP DIMMING	 NIGHT LIGHT FUNCTION	98527 <hr/> 98685
<ol style="list-style-type: none"> 1. warmwhite (2700K/100%) 2. neutralwhite 3850K (2700K/50% + 5000K/50%) 3. coldwhite (5000K/100%) 			



98685

LED

incl./inkl./inclus



98527 CANICOSA 2

wall / ceiling light; plastic, steel, black, gold / plastic with granille, transparent

Wand- / Deckenleuchte; Kunststoff, Stahl, schwarz, gold / Kunststoff mit Granille, transparent

applique / plafonnier; plastique, acier, noir, or / plastique granité, transparent

H 90, Ø 495

				
24,5W	3200lm		Remote	

98685 CANICOSA 2

wall / ceiling light; plastic, steel, black, gold / plastic with granille, transparent

Wand- / Deckenleuchte; Kunststoff, Stahl, schwarz, gold / Kunststoff mit Granille, transparent

applique / plafonnier; plastique, acier, noir, or / plastique granité, transparent

H 145, Ø 765

				
4x 4,5W	2120lm		Remote	



9 002759 985271



9 002759 986858

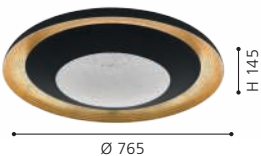



98487

LED



98023

LED



98488

LED

98023 MONTENOVO

wall / ceiling light; steel, white / glass, white, gold
Wand- / Deckenleuchte; Stahl, weiss / Glas, weiss, gold
applique / plafonnier; acier, blanc / verre, blanc, or

H 100, Ø 395



3x 7,3W 2220lm

98487 POZONDON

ceiling light; steel, gold-coloured / plastic, white
Deckenleuchte; Stahl, goldfarben / Kunststoff, weiss
plafonnier; acier, or / plastique, blanc

H 100, Ø 380



18W 2300lm

98488 POZONDON

ceiling light; steel, gold-coloured / plastic, white
Deckenleuchte; Stahl, goldfarben / Kunststoff, weiss
plafonnier; acier, or / plastique, blanc

H 120, Ø 520



22,5W 3100lm



9 002759 980238



9 002759 984878

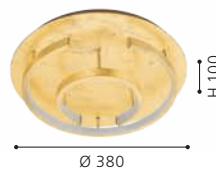

9 002759 984885

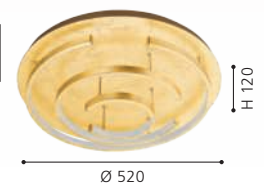



97526



incl./inkl./inclus



97527



incl./inkl./inclus



97528



incl./inkl./inclus



				<u>97526</u>	<u>97541</u>
TUNABLE WHITE	DIMMABLE	TIMER FUNCTION	NIGHT LIGHT FUNCTION	<u>97527</u>	<u>97542</u>
3000 - 5000 K	10 - 100 %	off after 30sec.		<u>97528</u>	<u>97543</u>

97526 GIRON

ceiling light; steel, white / plastic, white
Deckenleuchte; Stahl, weiss / Kunststoff, weiss
plafonnier; acier, blanc / plastique, blanc

H 75, Ø 570



36W



4300lm



Remote

97527 GIRON

ceiling light; steel, white / plastic, white
Deckenleuchte; Stahl, weiss / Kunststoff, weiss
plafonnier; acier, blanc / plastique, blanc

H 85, Ø 760



54,5W



6500lm



Remote

97528 GIRON

ceiling light; steel, white / plastic, white
Deckenleuchte; Stahl, weiss / Kunststoff, weiss
plafonnier; acier, blanc / plastique, blanc

H 120, Ø 1000



73W



9800lm



Remote



9 002759 975265

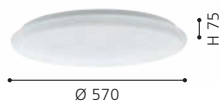

9 002759 975272



9 002759 975289

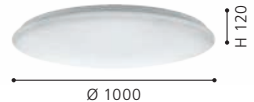



97541



incl./inkl./inclus



97542



incl./inkl./inclus



97543



incl./inkl./inclus



97541 GIRON-S

ceiling light; steel, white / plastic with crystal effect, white
Deckenleuchte; Stahl, weiss / Kunststoff m.Kristalleffekt, weiss
plafonnier; acier, blanc / plastique avec effet cristal, blanc

H 75, Ø 570



36W



4300lm



Remote

97542 GIRON-S

ceiling light; steel, white / plastic with crystal effect, white
Deckenleuchte; Stahl, weiss / Kunststoff m.Kristalleffekt, weiss
plafonnier; acier, blanc / plastique avec effet cristal, blanc

H 85, Ø 760



54,5W



6500lm



Remote

97543 GIRON-S

ceiling light; steel, white / plastic with crystal effect, white
Deckenleuchte; Stahl, weiss / Kunststoff m.Kristalleffekt, weiss
plafonnier; acier, blanc / plastique avec effet cristal, blanc

H 120, Ø 1000



73W



9800lm



Remote



9 002759 975418

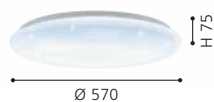

Ø 570



9 002759 975425

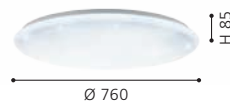

Ø 760



9 002759 975432

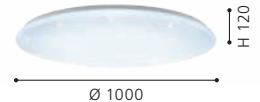

Ø 1000



97871

LED



97872

LED



97873

LED

97871 FRANIA

wall / ceiling light; steel, white / plastic, white
Wand- / Deckenleuchte; Stahl, weiss / Kunststoff, weiss
applique / plafonnier; acier, blanc / plastique, blanc

H 70, Ø 280

LED

10W

warm
WHITE

1100lm



97872 FRANIA

wall / ceiling light; steel, white / plastic, white
Wand- / Deckenleuchte; Stahl, weiss / Kunststoff, weiss
applique / plafonnier; acier, blanc / plastique, blanc

H 70, Ø 330

LED

14,6W

warm
WHITE

1600lm



97873 FRANIA

wall / ceiling light; steel, white / plastic, white
Wand- / Deckenleuchte; Stahl, weiss / Kunststoff, weiss
applique / plafonnier; acier, blanc / plastique, blanc

H 70, Ø 430

LED

6x 5,5W

warm
WHITE

3600lm



9 002759 978716

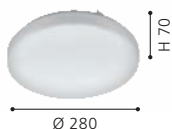

Ø 280



9 002759 978723



Ø 330



9 002759 978730

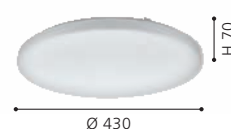

Ø 430



98446



98446 FRANIA

wall / ceiling light; steel, white / plastic, white
Wand- / Deckenleuchte; Stahl, weiss / Kunststoff, weiss
applique / plafonnier; acier, blanc / plastique, blanc

H 70, Ø 550



50W 5900lm





97877



97878



97879



97877 FRANIA-S

wall / ceiling light; steel, white / plastic with crystal effect, white
Wand- / Deckenleuchte; Stahl, weiss / Kunststoff m.Kristalleffekt, weiss
applique / plafonnier; acier, blanc / plastique avec effet cristal, blanc

H 70, Ø 280



10W



1100lm



97878 FRANIA-S

wall / ceiling light; steel, white / plastic with crystal effect, white
Wand- / Deckenleuchte; Stahl, weiss / Kunststoff m.Kristalleffekt, weiss
applique / plafonnier; acier, blanc / plastique avec effet cristal, blanc

H 70, Ø 330



14,6W



1600lm



97879 FRANIA-S

wall / ceiling light; steel, white / plastic with crystal effect, white
Wand- / Deckenleuchte; Stahl, weiss / Kunststoff m.Kristalleffekt, weiss
applique / plafonnier; acier, blanc / plastique avec effet cristal, blanc

H 70, Ø 430



6x 5,5W



3600lm



9 002759 978778

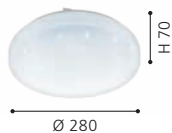

9 002759 978785



9 002759 978792





98448



98448 FRANIA-S

wall / ceiling light; steel, white / plastic with crystal effect, white
Wand- / Deckenleuchte; Stahl, weiss / Kunststoff m.Kristalleffekt, weiss
applique / plafonnier; acier, blanc / plastique avec effet cristal, blanc

H 70, Ø 550



50W 5900lm

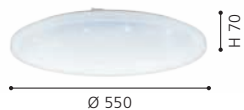



97874



97875



97876



97874 FRANIA

wall / ceiling light; steel, white / plastic, white
Wand- / Deckenleuchte; Stahl, weiss / Kunststoff, weiss
applique / plafonnier; acier, blanc / plastique, blanc

L 280, B 280, H 70



warm
WHITE
1100lm



9 002759 978747

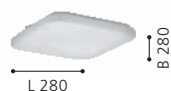

97875 FRANIA

wall / ceiling light; steel, white / plastic, white
Wand- / Deckenleuchte; Stahl, weiss / Kunststoff, weiss
applique / plafonnier; acier, blanc / plastique, blanc

L 330, B 330, H 70



warm
WHITE
1600lm



9 002759 978754

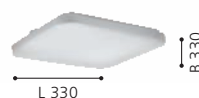

97876 FRANIA

wall / ceiling light; steel, white / plastic, white
Wand- / Deckenleuchte; Stahl, weiss / Kunststoff, weiss
applique / plafonnier; acier, blanc / plastique, blanc

L 430, B 430, H 70



warm
WHITE
3600lm



9 002759 978761

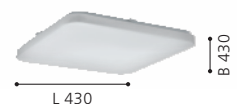



98447

LED

98447 FRANIA

wall / ceiling light; steel, white / plastic, white
Wand- / Deckenleuchte; Stahl, weiss / Kunststoff, weiss
applique / plafonnier; acier, blanc / plastique, blanc

L 530, B 530, H 70





97881



97882



97883



97881 FRANIA-S

wall / ceiling light; steel, white / plastic with crystal effect, white
Wand- / Deckenleuchte; Stahl, weiss / Kunststoff m. Kristalleffekt, weiss
applique / plafonnier; acier, blanc / plastique avec effet cristal, blanc

L 280, B 280, H 70

LED

warm
WHITE



10W 1100lm

97882 FRANIA-S

wall / ceiling light; steel, white / plastic with crystal effect, white
Wand- / Deckenleuchte; Stahl, weiss / Kunststoff m. Kristalleffekt, weiss
applique / plafonnier; acier, blanc / plastique avec effet cristal, blanc

L 330, B 330, H 70

LED

warm
WHITE



14,6W 1600lm

97883 FRANIA-S

wall / ceiling light; steel, white / plastic with crystal effect, white
Wand- / Deckenleuchte; Stahl, weiss / Kunststoff m. Kristalleffekt, weiss
applique / plafonnier; acier, blanc / plastique avec effet cristal, blanc

L 430, B 430, H 70

LED

warm
WHITE



6x 5,5W 3600lm



9 002759 978815

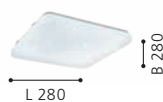

9 002759 978822

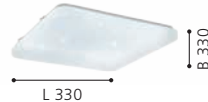

9 002759 978839

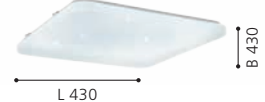



98449

LED

98449 FRANIA-S

wall / ceiling light; steel, white / plastic with crystal effect, white

Wand- / Deckenleuchte; Stahl, weiss / Kunststoff m. Kristalleffekt, weiss

applique / plafonnier; acier, blanc / plastique avec effet cristal, blanc

L 530, B 530, H 70

LED

50W

warm
WHITE

5900lm



9 002759 984496

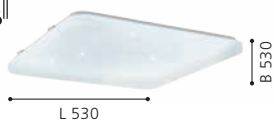



99341

LED

incl./inkl./inclus



99342

LED

incl./inkl./inclus



97577

LED

incl./inkl./inclus



TUNABLE WHITE
2700 - 6500 K

STEP DIMMING
10/25/50/100 %

97577

97578

99341 ZAMUDILO

ceiling light; steel, white / plastic with crystal effect, white, silver
Deckenleuchte; Stahl, weiss / Kunststoff m. Kristalleffekt, weiss, silber
plafonnier; acier, blanc / plastique avec effet cristal, blanc, argent

H 90, Ø 400



16,5W



1850lm



Remote

99342 ZAMUDILO

ceiling light; steel, white / plastic with crystal effect, white, silver
Deckenleuchte; Stahl, weiss / Kunststoff m. Kristalleffekt, weiss, silber
plafonnier; acier, blanc / plastique avec effet cristal, blanc, argent

H 90, Ø 500



21,6W



2450lm



Remote

97577 SILERAS

wall / ceiling light; steel, white / plastic with crystal effect, white
Wand- / Deckenleuchte; Stahl, weiss / Kunststoff m. Kristalleffekt, weiss
applique / plafonnier; acier, blanc / plastique avec effet cristal, blanc

H 85, Ø 450



22,5W



2800lm



Remote



9 002759 993412

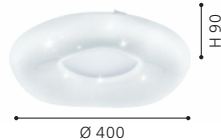

Ø 400



9 002759 993429



Ø 500



9 002759 975777



Ø 450



97578



99108



99109



97578 SILERAS

wall / ceiling light; steel, white / plastic with crystal effect, white
Wand- / Deckenleuchte; Stahl, weiss / Kunststoff m. Kristalleffekt, weiss
applique / plafonnier; acier, blanc / plastique avec effet cristal, blanc

H 85, Ø 600



35W 4400lm

Remote

99108 RUIDERA

ceiling light; steel, white / plastic, white, silver
Deckenleuchte; Stahl, weiss / Kunststoff, weiss, silber
plafonnier; acier, blanc / plastique, blanc, argent

H 90, Ø 480



22W 2500lm

99109 RUIDERA

ceiling light; steel, white / plastic, white, silver
Deckenleuchte; Stahl, weiss / Kunststoff, weiss, silber
plafonnier; acier, blanc / plastique, blanc, argent

L 480, B 480, H 90



22W 2500lm





2700 K
4500 K
6500 K

95972

95973



96026



VOLTAGO 2

These luminaires come with an interesting glitter-effect.

Diese Leuchten sind mit einem interessanten Glitzer-Effekt ausgestattet.

Ces luminaires viennent avec un effet scintillant intéressant.



95972



96026 CAPASSO 1

wall / ceiling light; steel, white / plastic, white, chrome
Wand- / Deckenleuchte; Stahl, weiss / Kunststoff, weiss, chrom
applique / plafonnier; acier, blanc / plastique, blanc, chrome

H 70, Ø 400



20W



2400lm



95972 VOLTAGO 2

wall / ceiling light; steel, white / plastic with crystal effect, white
Wand- / Deckenleuchte; Stahl, weiss / Kunststoff m. Kristalleffekt, weiss
applique / plafonnier; acier, blanc / plastique avec effet cristal, blanc

H 105, Ø 380



4x 4,8W



1920lm



Remote



95973 VOLTAGO 2

wall / ceiling light; steel, white / plastic with crystal effect, white
Wand- / Deckenleuchte; Stahl, weiss / Kunststoff m. Kristalleffekt, weiss
applique / plafonnier; acier, blanc / plastique avec effet cristal, blanc

H 125, Ø 580



4x 8,2W



3800lm



Remote



9 002759 960261



9 002759 959722



9 002759 959739





95973

LED

incl./inkl./inclus





97738

LED

incl./inkl./inclus



98323

LED

incl./inkl./inclus



98324

LED

incl./inkl./inclus

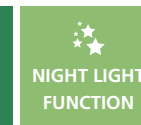
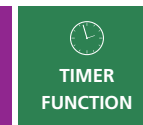

98323

98324

97737

97738

10 - 100 %

off after 30sec.

97738 LANCIANO

ceiling light; steel, white, transparent / plastic with crystal effect, white, silver

Deckenleuchte; Stahl, weiss, transparent / Kunststoff m. Kristalleffekt, weiss, silber

plafonnier; acier, blanc, transparent / plastique avec effet cristal, blanc, argent

H 105, Ø 860



56W



6800lm



Remote

98323 LANCIANO 1

wall / ceiling light; steel, white, transparent / plastic with crystal effect, white, chrome

Wand- / Deckenleuchte; Stahl, weiss, transparent / Kunststoff m. Kristalleffekt, weiss, chrom

applique / plafonnier; acier, blanc, transparent / plastique avec effet cristal, blanc, chrome

H 75, Ø 400



24W



1900lm



Remote

98324 LANCIANO 1

wall / ceiling light; steel, white, transparent / plastic with crystal effect, white, chrome

Wand- / Deckenleuchte; Stahl, weiss, transparent / Kunststoff m. Kristalleffekt, weiss, chrom

applique / plafonnier; acier, blanc, transparent / plastique avec effet cristal, blanc, chrome

H 80, Ø 560



33W



4000lm



Remote



9 002759 977382

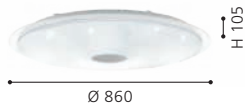

9 002759 983239

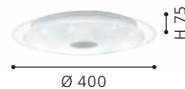

9 002759 983246

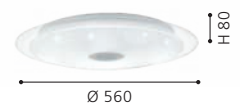



97737



900598



900599



97737 LANCIANO

ceiling light; steel, plastic, white, transparent / plastic with crystal effect, white, silver
 Deckenleuchte; Stahl, Kunststoff, weiss, transparent / Kunststoff m. Kristalleffekt, weiss, silber
 plafonnier; acier, plastique, blanc, transparent / plastique avec effet cristal, blanc, argent
 H 100, Ø 660



900598 LANCIANO 1

ceiling light; steel, wood, white, brown / plastic, white
 Deckenleuchte; Stahl, Holz, weiss, braun / Kunststoff, weiss
 plafonnier; acier, bois, blanc, marron / plastique, blanc

H 70, Ø 380



900599 LANCIANO 1

ceiling light; steel, wood, white, brown / plastic, white
 Deckenleuchte; Stahl, Holz, weiss, braun / Kunststoff, weiss
 plafonnier; acier, bois, blanc, marron / plastique, blanc

H 80, Ø 480



9 002759 977375

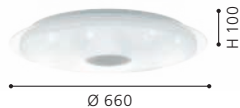

9 008606 244973

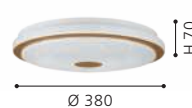

9 008606 244980

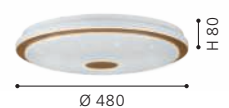



900608

LED



900607

LED

900608 FERENTINO

ceiling light; steel, white / plastic, white
 Deckenleuchte; Stahl, weiss / Kunststoff, weiss
 plafonnier; acier, blanc / plastique, blanc

H 60, Ø 380



19,5W 2300lm

900607 FERENTINO

ceiling light; steel, white / plastic, white
 Deckenleuchte; Stahl, weiss / Kunststoff, weiss
 plafonnier; acier, blanc / plastique, blanc

H 60, Ø 280



10W 1100lm



9 008606 245062

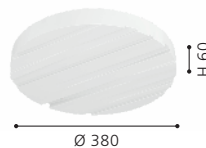

9 008606 245055

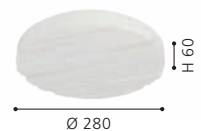



900609



900611



900609 FERENTINO

ceiling light; steel, white / plastic, white
Deckenleuchte; Stahl, weiss / Kunststoff, weiss
plafonnier; acier, blanc / plastique, blanc

L 280, B 280, H 60



10W



1100lm



900611 FERENTINO

ceiling light; steel, white / plastic, white
Deckenleuchte; Stahl, weiss / Kunststoff, weiss
plafonnier; acier, blanc / plastique, blanc

L 330, B 330, H 60



14,6W



1600lm



9 008606 245079

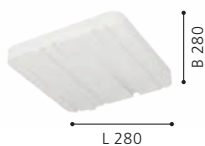

9 008606 245086





900605

LED

incl./inkl./inclus



900606

LED

incl./inkl./inclus



900605 BATTISTONA

ceiling light; steel, white / plastic, white
Deckenleuchte; Stahl, weiss / Kunststoff, weiss
plafonnier; acier, blanc / plastique, blanc

H 85, Ø 380



4x 2,9W



1280lm



4x 1,45



Remote



9 008606 245031



900606 BATTISTONA

ceiling light; steel, white / plastic, white
Deckenleuchte; Stahl, weiss / Kunststoff, weiss
plafonnier; acier, blanc / plastique, blanc

H 100, Ø 480



20,8W



2500lm



Remote



9 008606 245048

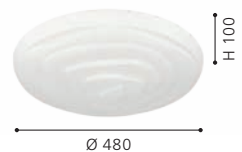



99343

LED



99465

LED



99344

LED

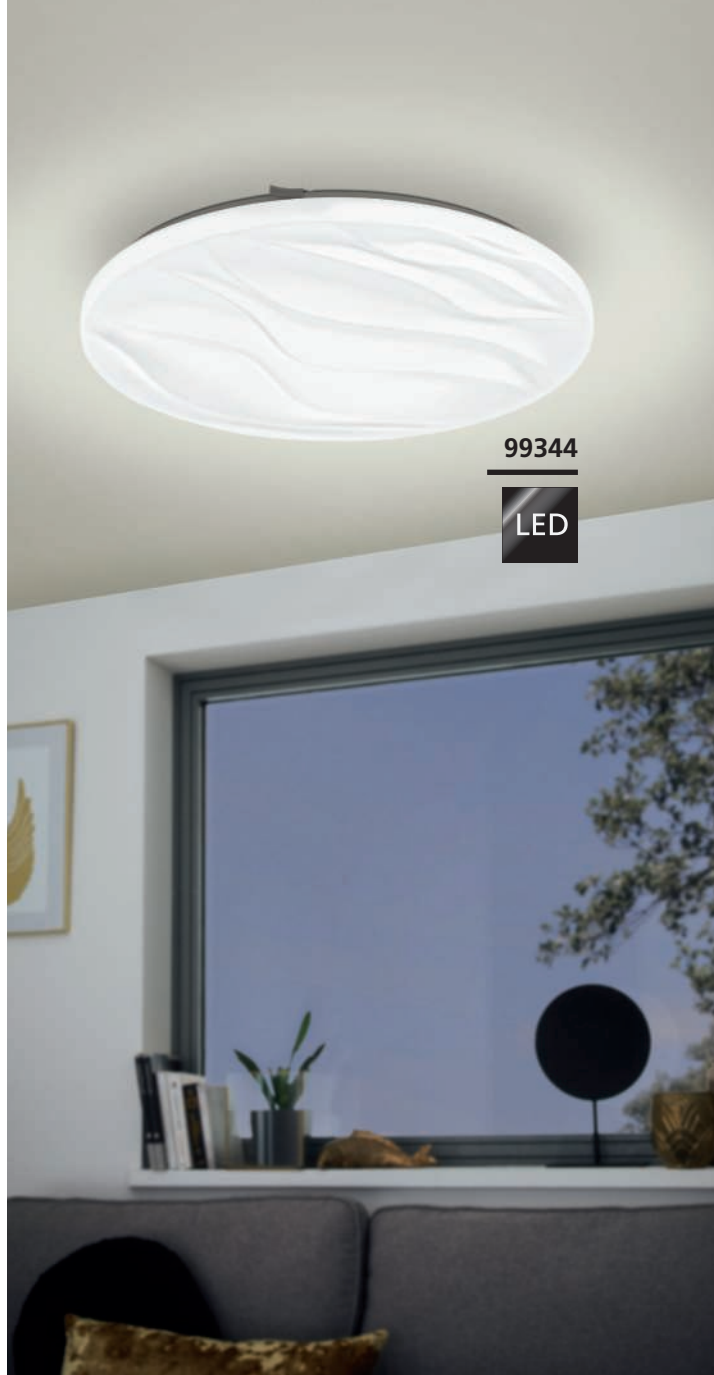

99343 BENARIBA

wall / ceiling light; steel, white / plastic, white
Wand- / Deckenleuchte; Stahl, weiss / Kunststoff, weiss
applique / plafonnier; acier, blanc / plastique, blanc

H 65, Ø 330



14,6W 1600lm

99465 BENARIBA

wall / ceiling light; steel, white / plastic, white
Wand- / Deckenleuchte; Stahl, weiss / Kunststoff, weiss
applique / plafonnier; acier, blanc / plastique, blanc

H 70, Ø 550



8x 4,4W 4240lm

99344 BENARIBA

wall / ceiling light; steel, white / plastic, white
Wand- / Deckenleuchte; Stahl, weiss / Kunststoff, weiss
applique / plafonnier; acier, blanc / plastique, blanc

H 70, Ø 440



22W 2500lm



9 002759 993436



9 002759 994655



9 002759 993443





95677

LED





95679



95677 COMPETA 1

wall / ceiling light; steel, white / plastic, white, silver, clear
 Wand- / Deckenleuchte; Stahl, weiss / Kunststoff, weiss, silber, klar
 applique / plafonnier; acier, blanc / plastique, blanc, argent, transparent

H 75, Ø 335



15,6W 1900lm

95679 COMPETA 1

wall / ceiling light; steel, white / plastic, white, silver, clear
 Wand- / Deckenleuchte; Stahl, weiss / Kunststoff, weiss, silber, klar
 applique / plafonnier; acier, blanc / plastique, blanc, argent, transparent

L 340, B 340, H 80



21W 2400lm

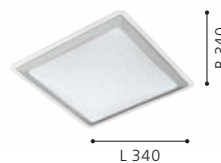



96032



96033



96034



96032 COMPETA 1

wall / ceiling light; steel, white / plastic, white, satined nickel
Wand- / Deckenleuchte; Stahl, weiss / Kunststoff, weiss, nickel-
matt
applique / plafonnier; acier, blanc / plastique, blanc, nickel mat

H 55, Ø 245



15,6W 1900lm

96033 COMPETA 1

wall / ceiling light; steel, white / plastic, white, satined nickel
Wand- / Deckenleuchte; Stahl, weiss / Kunststoff, weiss, nickel-
matt
applique / plafonnier; acier, blanc / plastique, blanc, nickel mat

H 55, Ø 325



18W 2200lm

96034 COMPETA 1

wall / ceiling light; steel, white / plastic, white, satined nickel
Wand- / Deckenleuchte; Stahl, weiss / Kunststoff, weiss, nickel-
matt
applique / plafonnier; acier, blanc / plastique, blanc, nickel mat

H 55, Ø 430



20W 2400lm



9 002759 960322



9 002759 960339



9 002759 960346





95682



95684



95682 PALERMO 2

wall / ceiling light; steel, white / plastic, white, chrome
Wand- / Deckenleuchte; Stahl, weiss / Kunststoff, weiss, chrom
applique / plafonnier; acier, blanc / plastique, blanc, chrome

H 70, Ø 280



15,6W 1900lm

95684 PALERMO 2

wall / ceiling light; steel, white / plastic, white, chrome
Wand- / Deckenleuchte; Stahl, weiss / Kunststoff, weiss, chrom
applique / plafonnier; acier, blanc / plastique, blanc, chrome

H 60, Ø 410



20W 2400lm



9 002759 956820



9 002759 956844





96023



900149



900335



96023 CAPASSO

wall / ceiling light; steel, white / plastic, white, chrome
Wand- / Deckenleuchte; Stahl, weiss / Kunststoff, weiss, chrom
applique / plafonnier; acier, blanc / plastique, blanc, chrome

H 65, Ø 340



18W 2200lm

900149 CAPASSO

wall / ceiling light; steel, white / plastic, white, black
Wand- / Deckenleuchte; Stahl, weiss / Kunststoff, weiss, schwarz
applique / plafonnier; acier, blanc / plastique, blanc, noir

H 60, Ø 340



14,6W 1600lm

900335 CAPASSO

wall / ceiling light; steel, white / plastic, white, black
Wand- / Deckenleuchte; Stahl, weiss / Kunststoff, weiss, schwarz
applique / plafonnier; acier, blanc / plastique, blanc, noir

H 60, Ø 480



19,5W 2200lm



9 002759 960230



9 008606 243471

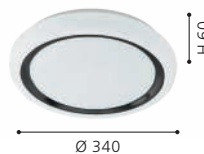

9 008606 243488

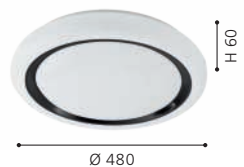



900612



900613



900612 RENDE

ceiling light; steel, white / plastic, white, gold
Deckenleuchte; Stahl, weiss / Kunststoff, weiss, gold
plafonnier; acier, blanc / plastique, blanc, or

H 60, Ø 380



19,5W 2300lm

900613 RENDE

ceiling light; steel, white / plastic, white, silver
Deckenleuchte; Stahl, weiss / Kunststoff, weiss, silber
plafonnier; acier, blanc / plastique, blanc, argent

L 380, B 380, H 60



19,5W 2300lm



9 008606 245093



9 008606 245109

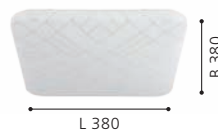



900498

LED



900499

LED



900501

LED



900498 NIEVES 1

wall / ceiling light; steel, white / plastic, white, gold
Wand- / Deckenleuchte; Stahl, weiss / Kunststoff, weiss, gold
applique / plafonnier; acier, blanc / plastique, blanc, or

H 60, Ø 310

LED

warm
WHITE
1100lm



10W

1100lm

900499 NIEVES 1

wall / ceiling light; steel, white / plastic, white, gold
Wand- / Deckenleuchte; Stahl, weiss / Kunststoff, weiss, gold
applique / plafonnier; acier, blanc / plastique, blanc, or

H 65, Ø 410

LED

warm
WHITE
2300lm



19,5W

2300lm

900501 NIEVES 1

wall / ceiling light; steel, white / plastic, white, gold
Wand- / Deckenleuchte; Stahl, weiss / Kunststoff, weiss, gold
applique / plafonnier; acier, blanc / plastique, blanc, or

H 70, Ø 510

LED

warm
WHITE
3710lm



7x 4,4W

3710lm



9 008606 239634

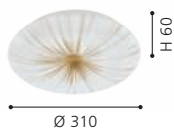

9 008606 239641



9 008606 239658

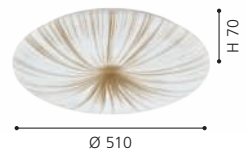



99699

LED



98325

LED

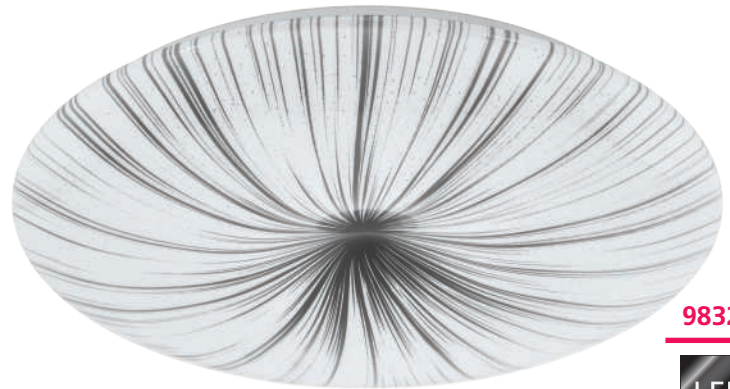

98326

LED

99699 NIEVES

wall / ceiling light; steel, white / plastic, white, silver
Wand- / Deckenleuchte; Stahl, weiss / Kunststoff, weiss, silber
applique / plafonnier; acier, blanc / plastique, blanc, argent

H 60, Ø 310



10W 1100lm

98325 NIEVES

wall / ceiling light; steel, white / plastic, white, silver
Wand- / Deckenleuchte; Stahl, weiss / Kunststoff, weiss, silber
applique / plafonnier; acier, blanc / plastique, blanc, argent

H 65, Ø 410



19,5W 2300lm

98326 NIEVES

wall / ceiling light; steel, white / plastic, white, silver
Wand- / Deckenleuchte; Stahl, weiss / Kunststoff, weiss, silber
applique / plafonnier; acier, blanc / plastique, blanc, argent

H 70, Ø 510



7x 4,4W 3710lm



9 002759 996994

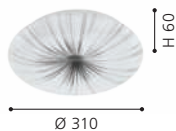

9 002759 983253

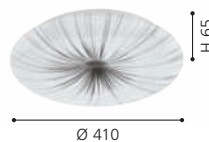

9 002759 983260

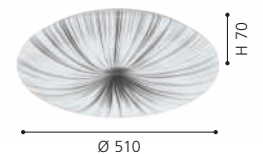



99406



99407



98603



99406 PESCAITO

wall / ceiling light; steel, black / plastic, white, gold
Wand- / Deckenleuchte; Stahl, schwarz / Kunststoff, weiss, gold
applique / plafonnier; acier, noir / plastique, blanc, or

H 65, Ø 280



10W 1100lm

99407 PESCAITO

wall / ceiling light; steel, black / plastic, white, gold
Wand- / Deckenleuchte; Stahl, schwarz / Kunststoff, weiss, gold
applique / plafonnier; acier, noir / plastique, blanc, or

H 65, Ø 380



19,5W 2300lm

98603 MUSURITA

ceiling light; plastic, steel, black / plastic, white
Deckenleuchte; Kunststoff, Stahl, schwarz / Kunststoff, weiss
plafonnier; plastique, acier, noir / plastique, blanc

H 60, Ø 340



14,6W 1600lm



9 002759 994068

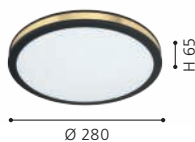

9 002759 994075

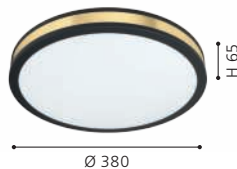

9 002759 986032





98604



98602



98601

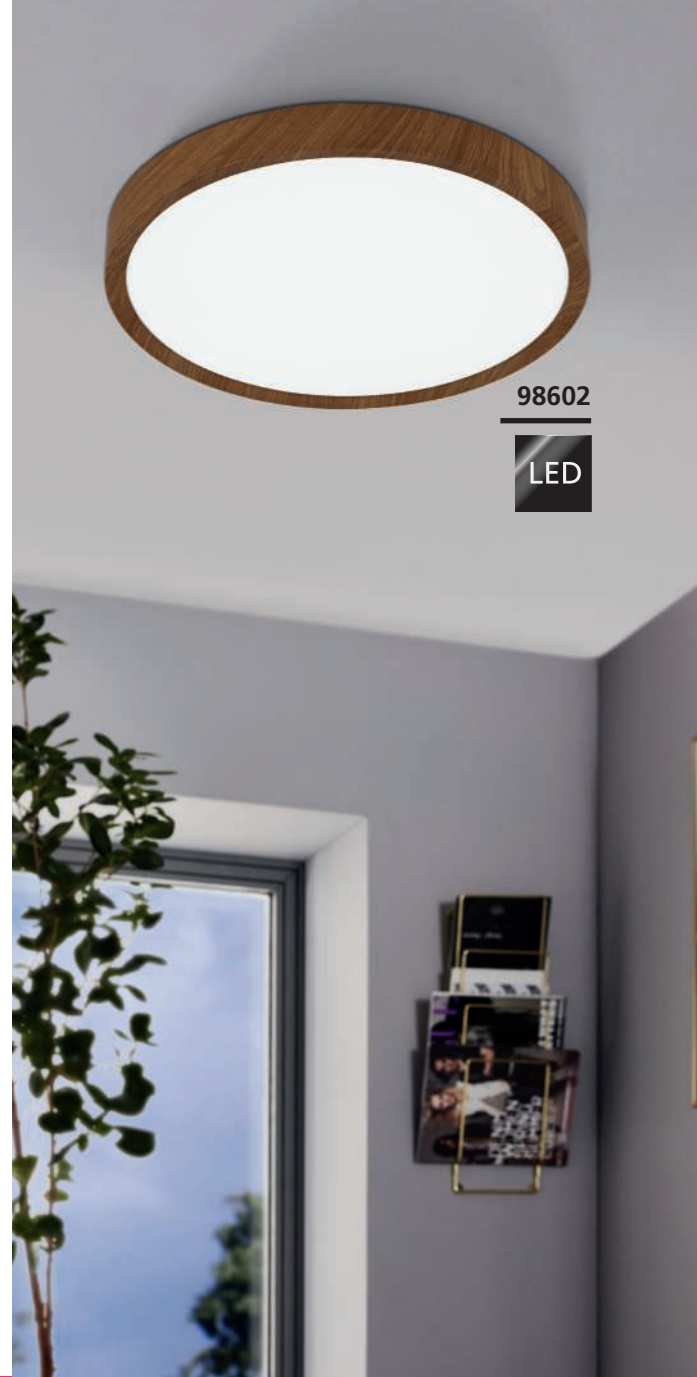

98604 MUSURITA

ceiling light; plastic, steel, black / plastic, white
 Deckenleuchte; Kunststoff, Stahl, schwarz / Kunststoff, weiss
 plafonnier; plastique, acier, noir / plastique, blanc

H 75, Ø 440



6x 5,5 W 3600 lm

98601 MUSURITA

ceiling light; plastic, steel, natural wood look / plastic, white
 Deckenleuchte; Kunststoff, Stahl, Holzoptik natur / Kunststoff, weiss
 plafonnier; plastique, acier, aspect bois naturel / plastique, blanc

H 60, Ø 340



14,6 W 1600 lm

98602 MUSURITA

ceiling light; plastic, steel, natural wood look / plastic, white
 Deckenleuchte; Kunststoff, Stahl, Holzoptik natur / Kunststoff, weiss
 plafonnier; plastique, acier, aspect bois naturel / plastique, blanc

H 75, Ø 440



6x 5,5 W 3600 lm



9 002759 986049

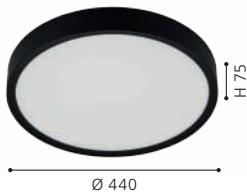

9 002759 986018



9 002759 986025





99782



incl./inkl./inclus



99783



incl./inkl./inclus



99779



incl./inkl./inclus



99782 LAURITO

ceiling light; steel, white / plastic, grey, white
Deckenleuchte; Stahl, weiss / Kunststoff, grau, weiss
plafonnier; acier, blanc / plastique, gris, blanc

H 70, Ø 490



24W



2600lm



Remote

99783 LAURITO

ceiling light; steel, white / plastic, black, white
Deckenleuchte; Stahl, weiss / Kunststoff, schwarz, weiss
plafonnier; acier, blanc / plastique, noir, blanc

H 70, Ø 490



24W



2600lm



Remote

99779 SELUCI

ceiling light; steel, white / plastic, white, clear
Deckenleuchte; Stahl, weiss / Kunststoff, weiss, klar
plafonnier; acier, blanc / plastique, blanc, transparent

H 80, Ø 490



4x 10W



4600lm



Remote



9 002759 997823



9 002759 997830



9 002759 997793





99781

LED

incl./inkl./inclus



99781 SELUCI

ceiling light; steel, black / plastic, white, clear

Deckenleuchte; Stahl, schwarz / Kunststoff, weiss, klar

plafonnier; acier, noir / plastique, blanc, transparent

H 80, Ø 490



4x 10W



4600lm



Remote



9 002759 997816



SELUCI

Convenient light effect due to the indirect illumination.

Angenehmer Lichteffect durch indirekte Beleuchtung.

Effet de lumière pratique en raison de l'éclairage indirect.



99623

LED



99621

LED



99622

LED

99623 VALCASOTTO

ceiling light; steel, Mokka colour / plastic, white
Deckenleuchte; Stahl, Mokkafarben / Kunststoff, weiss
plafonnier; acier, café / plastique, blanc

H 75, Ø 370

LED

24W

warm
WHITE

2500lm



9 002759 996239



99621 VALCASOTTO

ceiling light; steel, black / plastic, white
Deckenleuchte; Stahl, schwarz / Kunststoff, weiss
plafonnier; acier, noir / plastique, blanc

H 75, Ø 370

LED

21,6W

warm
WHITE

2500lm



9 002759 996215



99622 VALCASOTTO

ceiling light; steel, brown / plastic, white
Deckenleuchte; Stahl, braun / Kunststoff, weiss
plafonnier; acier, marron / plastique, blanc

H 75, Ø 370

LED

24W

warm
WHITE

2500lm



9 002759 996222





900463



900464



900463 LUPPINERIA

ceiling light; steel, plastic, sandy, white / wood, brown
Deckenleuchte; Stahl, Kunststoff, sandfarben, weiss / Holz, braun
plafonnier; acier, plastique, couleur sable, blanc / bois, marron

H 80, Ø 380



24W 2500lm



9 008606 244027



900464 LUPPINERIA

ceiling light; plastic, steel, white / wood, brown
Deckenleuchte; Kunststoff, Stahl, weiss / Holz, braun
plafonnier; plastique, acier, blanc / bois, marron

H 80, Ø 380



24W 2500lm



9 008606 244034

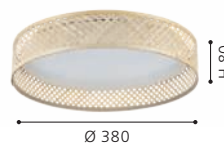



99703



99704



99703 PENJAMO

ceiling light; steel, black / plastic with crystal effect, white
 Deckenleuchte; Stahl, schwarz / Kunststoff m. Kristalleffekt, weiss
 plafonnier; acier, noir / plastique avec effet cristal, blanc

H 60, Ø 465



3x 7,3W 2010lm

99704 PENJAMO

ceiling light; steel, Mokka colour / plastic with crystal effect, white
 Deckenleuchte; Stahl, Mokkafarben / Kunststoff m. Kristalleffekt, weiss
 plafonnier; acier, café / plastique avec effet cristal, blanc

H 60, Ø 465



3x 7,3W 2010lm



9 002759 997038



9 002759 997045





900601



900602



900601 CALAGRANO

ceiling light; steel, black / plastic, white
 Deckenleuchte; Stahl, schwarz / Kunststoff, weiss
 plafonnier; acier, noir / plastique, blanc

H 60, Ø 380



900602 CALAGRANO

ceiling light; steel, black / plastic, white
 Deckenleuchte; Stahl, schwarz / Kunststoff, weiss
 plafonnier; acier, noir / plastique, blanc

L 375, B 375, H 60

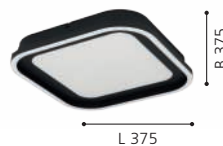



99397



99397

The wall switch controls the luminaire's light colour.

Über den Wandschalter kann die Lichtfarbe der Leuchte gesteuert werden.

La couleur de lumière du luminaire peut être commandée par l'interrupteur mural.



99398



99398

The wall switch controls the luminaire's light colour.

Über den Wandschalter kann die Lichtfarbe der Leuchte gesteuert werden.

La couleur de lumière du luminaire peut être commandée par l'interrupteur mural.



99397 MENTALURGIA

wall / ceiling light; steel, white, chrome / plastic, white
Wand- / Deckenleuchte; Stahl, weiss, chrom / Kunststoff, weiss
applique / plafonnier; acier, blanc, chrome / plastique, blanc

L 495, B 465, H 65



9 002759 993979



99398 MENTALURGIA

wall / ceiling light; steel, white, chrome / plastic, white
Wand- / Deckenleuchte; Stahl, weiss, chrom / Kunststoff, weiss
applique / plafonnier; acier, blanc, chrome / plastique, blanc

L 490, B 490, H 65



9 002759 993986

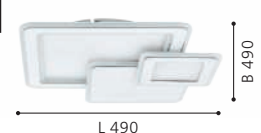

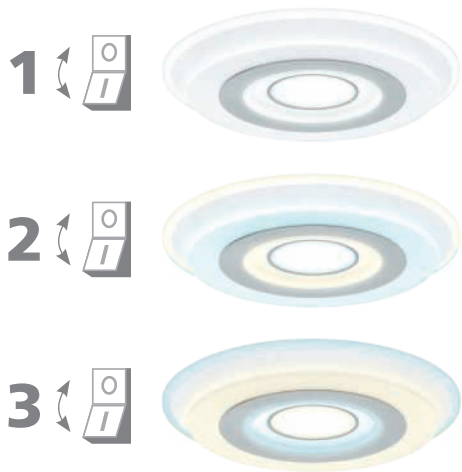

99399



99399

The wall switch controls the luminaire's light colour.

Über den Wandschalter kann die Lichtfarbe der Leuchte gesteuert werden.

La couleur de lumière du luminaire peut être commandée par l'interrupteur mural.

99399 REDUCTA 2

wall / ceiling light; plastic, white
Wand- / Deckenleuchte; Kunststoff, weiss
applique / plafonnier; plastique, blanc

H 45, Ø 490

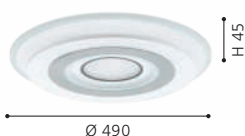



81635



83404



81636

81635 ELLA

wall / ceiling light; steel, white / glass opal-matt, white
Wand- / Deckenleuchte; Stahl, weiss / Glas opal-matt, weiss
applique / plafonnier; acier, blanc / verre opale mat, blanc

H 92, Ø 200



E27

1x 60W

81636 ELLA

wall / ceiling light; steel, white / glass opal-matt, white
Wand- / Deckenleuchte; Stahl, weiss / Glas opal-matt, weiss
applique / plafonnier; acier, blanc / verre opale mat, blanc

H 117, Ø 280



E27

1x 60W

83404 ELLA

wall / ceiling light; steel, white / glass opal-matt, white
Wand- / Deckenleuchte; Stahl, weiss / Glas opal-matt, weiss
applique / plafonnier; acier, blanc / verre opale mat, blanc

H 127, Ø 350



E27

2x 60W



9 002759 816353

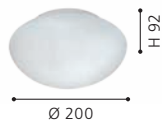

9 002759 816360



9 002759 834043





94973



94973 DURELO

ceiling light; plastic, white / glass, white
Deckenleuchte; Kunststoff, weiss / Glas, weiss
plafonnier; plastique, blanc / verre, blanc

H 195, Ø 160



E27



1x 28W



9 002759 949730





82942



83155

82942 PLANET

wall / ceiling light; steel, satin nickel / satin glass, white, clear
Wand- / Deckenleuchte; Stahl, nickel-matt / Glas satiniert, weiss, klar
applique / plafonnier; acier, nickel mat / verre satiné, blanc, transparent

H 85, Ø 290



E27



1x 25W

83155 PLANET 1

wall / ceiling light; steel, chrome / glass painted, white, clear
Wand- / Deckenleuchte; Stahl, chrom / Glas lackiert, weiss, klar
applique / plafonnier; acier, chrome / verre laqué, blanc, transparent

H 85, Ø 290



E27



1x 25W



9 002759 829421



Ø 290



9 002759 831554



Ø 290



83156



83154



83153

83156 PLANET 1

wall light; steel, chrome / glass painted, white, clear
Wandleuchte; Stahl, chrom / Glas lackiert, weiss, klar
applique; acier, chrome / verre laqué, blanc, transparent

L 290, H 145, A 85



E27 1x 60W



9 002759 831561



83153 PLANET 1

wall / ceiling light; steel, white / glass painted, white, clear
Wand- / Deckenleuchte; Stahl, weiss / Glas lackiert, weiss, klar
applique / plafonnier; acier, blanc / verre laqué, blanc, transparent

H 85, Ø 290



E27 1x 25W



9 002759 831530



83154 PLANET 1

wall light; steel, white / glass painted, white, clear
Wandleuchte; Stahl, weiss / Glas lackiert, weiss, klar
applique; acier, blanc / verre laqué, blanc, transparent

L 290, H 145, A 85



E27 1x 60W



9 002759 831547





83157



83159

83157 PLANET 1

wall / ceiling light; steel, brass / glass painted, white, clear
Wand- / Deckenleuchte; Stahl, messing / Glas lackiert, weiss, klar
applique / plafonnier; acier, laiton / verre laqué, blanc, transparent

H 85, Ø 290



E27

1x 25W



9 002759 831578



Ø 290

83159 PLANET 1

wall / ceiling light; steel, black / glass painted, white, clear
Wand- / Deckenleuchte; Stahl, schwarz / Glas lackiert, weiss, klar
applique / plafonnier; acier, noir / verre laqué, blanc, transparent

H 85, Ø 290



E27

1x 25W



9 002759 831592



Ø 290

83162 PLANET 1

wall / ceiling light; steel, satin nickel / glass painted, white, clear
Wand- / Deckenleuchte; Stahl, nickel-matt / Glas lackiert, weiss, klar
applique / plafonnier; acier, nickel mat / verre laqué, blanc, transparent

H 85, Ø 290



E27

1x 25W



9 002759 831622



Ø 290



83162



83163

83163 PLANET 1

wall light; steel, satin nickel / glass painted, white, clear
Wandleuchte; Stahl, nickel-matt / Glas lackiert, weiss, klar
applique; acier, nickel mat / verre laqué, blanc, transparent

L 290, H 145, A 85



E27



1x 60W



9 002759 831639





96117

LED





96111

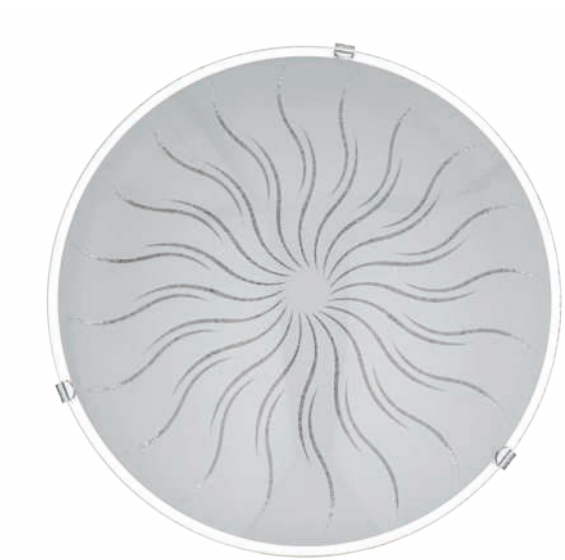

96089



96117 MARGITTA 1

wall / ceiling light; steel, white / glass, white, black, clear
Wand- / Deckenleuchte; Stahl, weiss / Glas, weiss, schwarz, klar
applique / plafonnier; acier, blanc / verre, blanc, noir, transparent

H 95, Ø 315



3x 11 W
3x
950lm



9 002759 961176



Ø 315

96089 MARGITTA 1

wall / ceiling light; steel, white / glass, granille white, clear
Wand- / Deckenleuchte; Stahl, weiss / Glas, granille weiss, klar
applique / plafonnier; acier, blanc / verre, blanc granille, transparent

H 70, Ø 250



3x 11 W
3x
950lm



9 002759 960896



Ø 250

96111 MARGITTA 1

wall / ceiling light; steel, white / glass, granille white, clear
Wand- / Deckenleuchte; Stahl, weiss / Glas, granille weiss, klar
applique / plafonnier; acier, blanc / verre, blanc granille, transparent

H 95, Ø 315



3x 11 W
3x
950lm



9 002759 961114



Ø 315



89248



89239

89248 MARS 1

wall / ceiling light; steel, white / satin glass, white, silver
Wand- / Deckenleuchte; Stahl, weiss / Glas satiniert, weiss, silber
applique / plafonnier; acier, blanc / verre satiné, blanc, argent

H 70, Ø 250



E27



1x 25W



9 002759 892487



Ø 250

89239 MARS 1

wall / ceiling light; steel, white / satin glass, design "beams"
Wand- / Deckenleuchte; Stahl, weiss / Glas satiniert, Motiv
Strahlen
applique / plafonnier; acier, blanc / verre satiné, motif «rayons»

H 70, Ø 250



E27



1x 25W



9 002759 892395

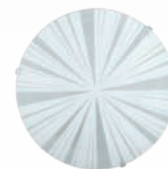

Ø 250



80263



80264



89238

80264 MARS

wall / ceiling light; steel, white / satin glass, design "leaves"
 Wand- / Deckenleuchte; Stahl, weiss / Glas satiniert, Motiv Blätter
 applique / plafonnier; acier, blanc / verre satiné, motif «feuilles»

H 70, Ø 250



9 002759 802646



Ø 250

80263 MARS

wall / ceiling light; steel, white / satin glass, design "triangles"
 Wand- / Deckenleuchte; Stahl, weiss / Glas satiniert, Motiv Dreiecke
 applique / plafonnier; acier, blanc / verre satiné, motif «triangles»

H 70, Ø 250



9 002759 802639



Ø 250

89238 MARS 1

wall / ceiling light; steel, white / satin glass, design "rose"
 Wand- / Deckenleuchte; Stahl, weiss / Glas satiniert, Motiv Rose
 applique / plafonnier; acier, blanc / verre satiné, motif «rose»

H 70, Ø 250



9 002759 892388



Ø 250



DESIGN
HIGHLIGHT
DETAIL



95672

LED



90043

95672 MAGITTA 1

wall / ceiling light; steel, white / glass, white, clear
Wand- / Deckenleuchte; Stahl, weiss / Glas, weiss, klar
applique / plafonnier; acier, blanc / verre, blanc, transparent

H 80, Ø 250



Ø 250

90043 SCALEA 1

wall / ceiling light; steel, white / satin glass, white with decor
Wand- / Deckenleuchte; Stahl, weiss / Glas satiniert, weiss
m.Dekor
applique / plafonnier; acier, blanc / verre satiné, blanc avec décor

H 100, Ø 315



Ø 315

89758 RAYA

wall / ceiling light; steel, white, chrome / satin glass, white, silver
Wand- / Deckenleuchte; Stahl, weiss, chrom / Glas satiniert,
weiss, silber
applique / plafonnier; acier, blanc, chrome / verre satiné, blanc,
argent

H 100, Ø 315

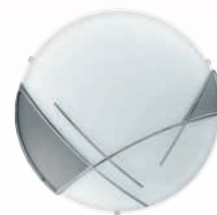

Ø 315

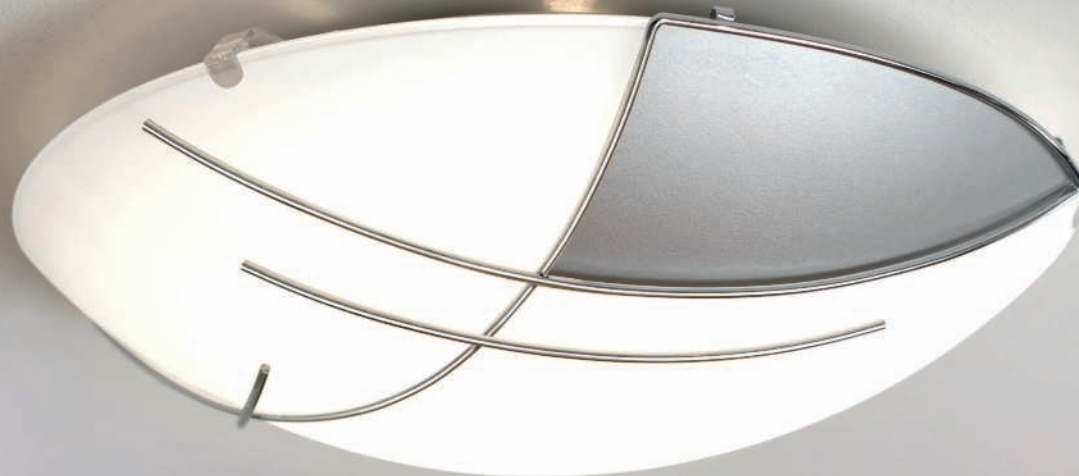

89758





83132



84028

83132 GRAFIK

wall / ceiling light; steel / satin glass, design "lines"
Wand- / Deckenleuchte; Stahl / Glas satiniert, Motiv Linien
applique / plafonnier; acier / verre satiné, motif «lignes»

L 180, H 210, A 85



E27



1x 60W



9 002759 831325

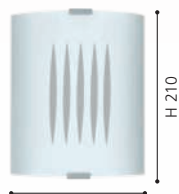

L 180

H 210

84028 GRAFIK

wall / ceiling light; steel, silver / satin glass, white
Wand- / Deckenleuchte; Stahl, silber / Glas satiniert, weiss
applique / plafonnier; acier, argent / verre satiné, blanc

L 180, H 210, A 85



E27



1x 60W



9 002759 840280

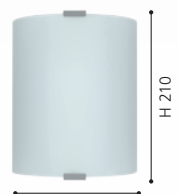

L 180

H 210

83119 NEMO

wall light; steel, satin nickel / glass opal-matt, white
Wandleuchte; Stahl, nickel-matt / Glas opal-matt, weiss
applique; acier, nickel mat / verre opale mat, blanc

L 150, H 320, A 95



E27



1x 25W



9 002759 831196



L 150

H 320



83119



80265



7186



7184

80265 MARS

wall / ceiling light; steel, white / satin glass, white
Wand- / Deckenleuchte; Stahl, weiss / Glas satiniert, weiss
applique / plafonnier; acier, blanc / verre satiné, blanc

H 70, Ø 250



E27



1x 25W



9 002759 802653



Ø 250

7186 SALOME

wall / ceiling light; steel, chrome / glass alabaster, white
Wand- / Deckenleuchte; Stahl, chrom / Glas alabaster, weiss
applique / plafonnier; acier, chrome / verre albâtre, blanc

H 90, Ø 300



E27



1x 25W



9 002759 718602



Ø 300

7184 SALOME

wall / ceiling light; steel, chrome / glass alabaster, white
Wand- / Deckenleuchte; Stahl, chrom / Glas alabaster, weiss
applique / plafonnier; acier, chrome / verre albâtre, blanc

H 110, Ø 400



E27



2x 25W



9 002759 718404



Ø 400



7188

7188 SALOME

wall light; steel, chrome / glass alabaster, white
Wandleuchte; Stahl, chrom / Glas alabaster, weiss
applique; acier, chrome / verre albâtre, blanc

L 300, H 150, A 90



E27



1x 60W



9 002759 718800



SALOME

These luminaires have a beautiful alabaster glass.

Diese Leuchten besitzen ein wunderschönes Alabasterglas.

Ces luminaires ont un beau verre d'albâtre.





DESIGN
HIGHLIGHT
DETAIL



82741



86712

86712 MESTRE

wall / ceiling light; steel, antique-brown, gold / glass chalked, beige
Wand- / Deckenleuchte; Stahl, antik-braun, gold / Glas gekalkt, beige
applique / plafonnier; acier, marron antique, or / verre chaulé, beige
H 133, Ø 395



E27 2x 60W

82741 IMPERIAL

wall / ceiling light; cast metal, bronzed / satin glass, white
Wand- / Deckenleuchte; Metallguss, brüniert / Glas satiniert, weiss
applique / plafonnier; fonte métallique, brun / verre satiné, blanc

H 140, Ø 310



E27 2x 25W



9 002759 867126



9 002759 827410





89115



86715



87793

89115 ALMERA

wall light; steel, antique-brown / glass, champagne
Wandleuchte; Stahl, antik-braun / Glas, champagner
applique; acier, marron antique / verre, champagne

L 180, H 250, A 75



86715 MESTRE

wall light; steel, antique-brown, gold / glass chalked, beige
Wandleuchte; Stahl, antik-braun, gold / Glas gekalkt, beige
applique; acier, marron antique, or / verre chaulé, beige

L 300, H 335, A 160



87793 PASCAL 1

wall light; steel, antique-brown / glass chalked, beige
Wandleuchte; Stahl, antik-braun / Glas gekalkt, beige
applique; acier, marron antique / verre chaulé, beige

L 180, H 480, A 120





90737

90737, 90697

Rustic luminaire series with appealing leaf decor

Rustikale Leuchtenserie mit ansprechendem Blätterdekor

Série de luminaires rustique avec un décor de feuille plaisant



90697

90737 CAMPANIA

ceiling light; steel, antique-brown, gold / glass chalked, white
Deckenleuchte; Stahl, antik-braun, gold / Glas gekalkt, weiss
plafonnier; acier, marron antique, or / verre chaulé, blanc

H 115, Ø 775



G4 15x 10W

90697 GERBERA 1

ceiling light; steel, antique-brown, gold / satin glass, white
Deckenleuchte; Stahl, antik-braun, gold / Glas satiniert, weiss
plafonnier; acier, marron antique, or / verre satiné, blanc

H 90, Ø 780



G9 6x 33W

92143 COLTI

ceiling light; steel, antique-brown / satin glass, white painted
Deckenleuchte; Stahl, antik-braun / Glas satiniert, weiss lackiert
plafonnier; acier, marron antique / verre satiné, blanc laqué

H 95, Ø 350



E27 2x 25W



9 002759 907372

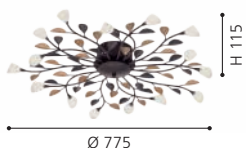

9 002759 906979

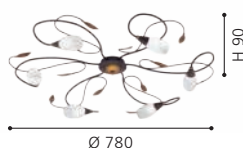

9 002759 921439

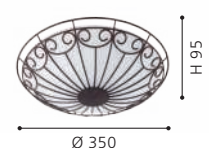



92143



97886



99348

Matching fabric luminaires
can be found from page 114.

Passende Stoffleuchten finden
Sie ab Seite 114.

Vous trouverez les luminaires à textile
assorties à partir de la page 114.

97886 SAN PERI

wall light; steel, black
Wandleuchte; Stahl, schwarz
applique; acier, noir

L 130, B 300, H 210



E27 1x 10W



9 002759 978860



99348 STAITI 1

wall light; steel, black / fabric, black
Wandleuchte; Stahl, schwarz / Textil, schwarz
applique; acier, noir / tissu, noir

L 160, H 240, A 500



E27 1x 40W



9 002759 993481





99348



96567

LED

TAZZOLI

These luminaires have a USB-connection.

Diese Leuchten verfügen über einen USB-Anschluss.

Ces luminaires disposent d'une connexion USB.



96567 TAZZOLI

wall light; steel, plastic, satin nickel, black
Wandleuchte; Stahl, Kunststoff, nickel-matt, schwarz
applique; acier, plastique, nickel mat, noir

L 65, H 300, A 160



3,8W 320lm



96566 TAZZOLI

wall light; steel, plastic, white
Wandleuchte; Stahl, Kunststoff, weiss
applique; acier, plastique, blanc

L 65, H 300, A 160



3,8W 320lm



98263 CIGLIE

wall light; aluminium, steel, black
Wandleuchte; Alu, Stahl, schwarz
applique; aluminium, acier, noir

L 180, H 180, A 210



1x 4,5W 1x 345lm





99595

LED



CARTIGNANO

This sleek, modern luminaire is multifunctional, providing illumination and a handy coat rack feature. It can be mounted directly on a wall outlet, and a cord with switch is included in your deliver.

Diese schlichte, moderne Leuchte dient nicht nur als Lichtquelle, sondern auch als Garderobe. Sie kann direkt im Wandauslass montiert werden, ein Kabel mit Schalter wird automatisch mitgeliefert.

Ce luminaire sobre et moderne peuvent non seulement servir de source de lumière, mais aussi de porte-manteau. Les deux lampes peuvent être directement montées sur une prise murale. Le câble avec interrupteur est inclus dans la livraison.

99595 CARTIGNANO

wall light; steel, black / plastic, white
Wandleuchte; Stahl, schwarz / Kunststoff, weiss
applique; acier, noir / plastique, blanc

L 780, H 180, A 35

LED

7,8W

warm
WHITE

900lm



9 002759 995959





99596



99596 CIVITATE

wall light; steel, wood, black, brown
Wandleuchte; Stahl, Holz, schwarz, braun
applique; acier, bois, noir, marron

L 760, B 100, H 85



18W



1900lm



9 002759 995966



CIVITATE

The CIVITATE LED wall luminaire features a rectangular, black metal body with rounded corners. Five brown, rubber-wood brackets provide space and support for coats and jackets, making this the ideal illuminated coat rack. The CIVITATE emits a warm, comfortable light, providing indirect illumination in your entrance area or foyer. The minimalist design complements a modern interior, and can easily be turned on and off with a switch on the cord.

Die LED Wandleuchte CIVITATE besteht aus einem rechteckigen, schwarzen Metall-Körper mit abgerundeten Ecken. Dank der fünf Halterungen aus braunem Gummibaumholz bietet die Wandlampe genügend Platz für Jacken sowie Mäntel und kann so optimal als beleuchtete Garderobe genutzt werden. Die Leuchte spendet angenehmes warmweißes Licht und schafft so eine indirekte Beleuchtung im Eingangsbereich. Die minimalistische Leuchte rundet moderne Einrichtungsstile ab und ist bequem über einen Schalter am Kabel ein- und ausschaltbar.

L'applique murale LED CIVITATE est composée d'un boîtier rectangulaire en métal noir avec des angles arrondis. Les cinq supports en bois d'hévéa brun permettent d'accrocher des vestes et des manteaux, ce qui permet à l'applique de servir également de porte-manteau. L'applique diffuse une lumière blanc chaud agréable, et ainsi un éclairage indirect pour les entrées. Minimaliste, elle complète des styles intérieurs modernes et peut être facilement actionnée grâce à l'interrupteur situé sur le câble.

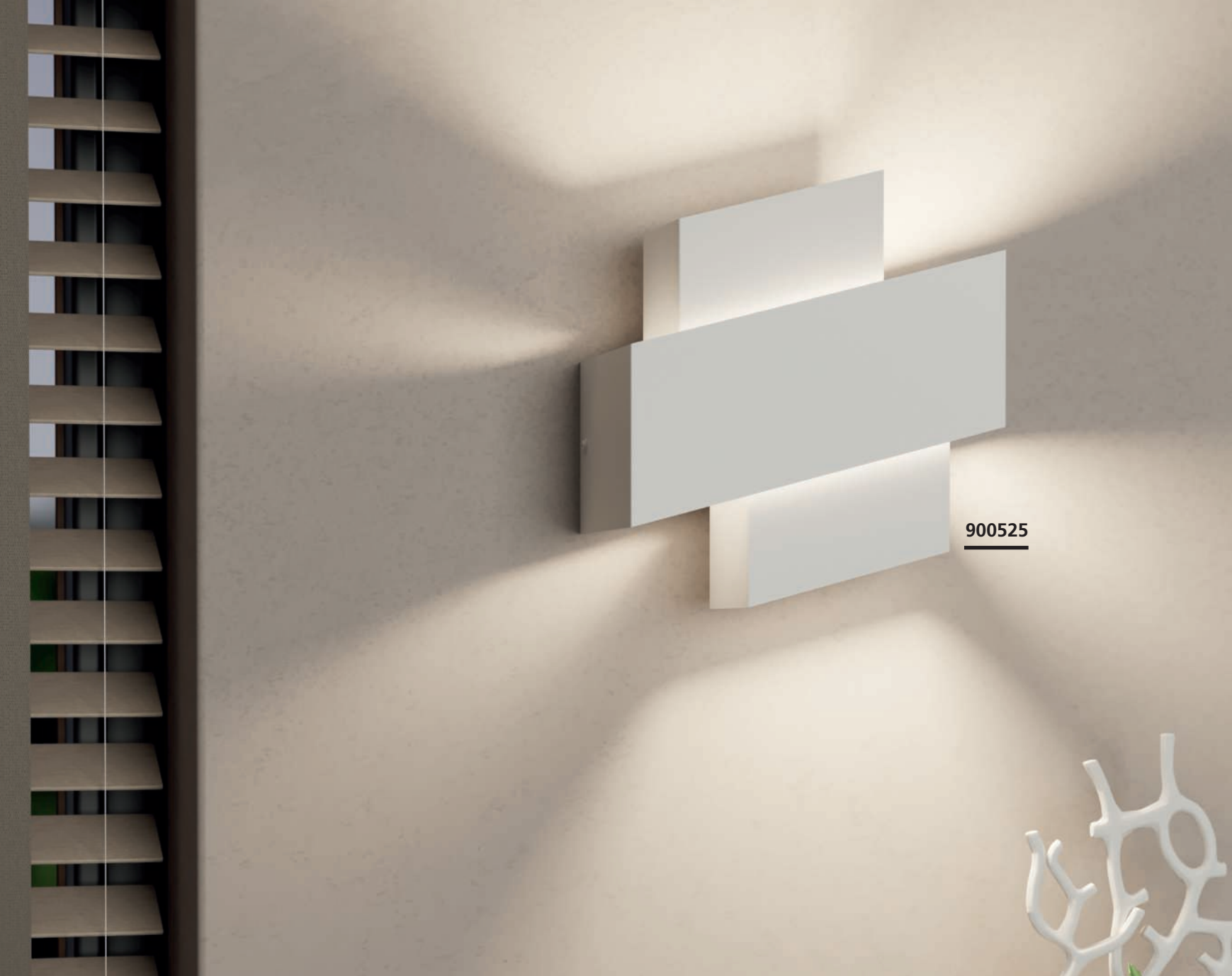

900525

900525 TIMPAROSSA

wall light; steel, white
 Wandleuchte; Stahl, weiss
 applique; acier, blanc

L 255, H 220, A 105

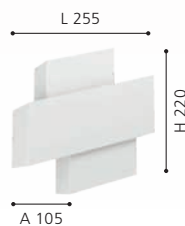

900526 TIMPAROSSA

wall light; steel, gold-coloured
 Wandleuchte; Stahl, goldfarben
 applique; acier, or

L 255, H 220, A 105

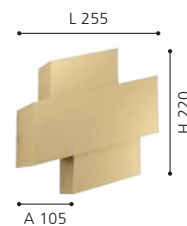

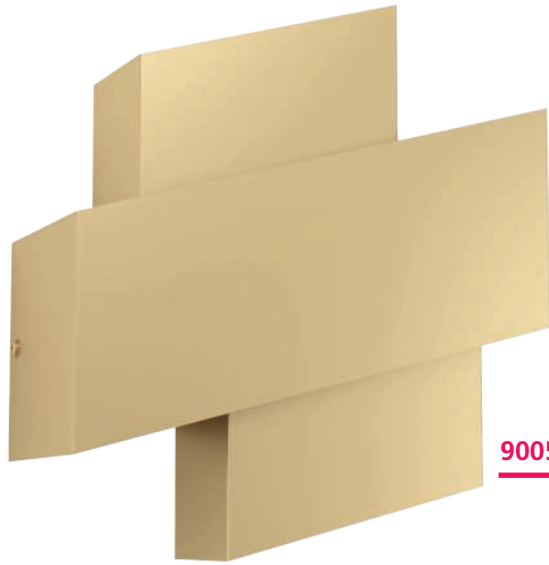

900526

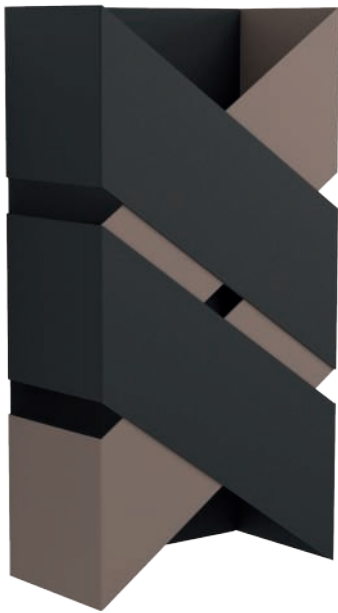

99689

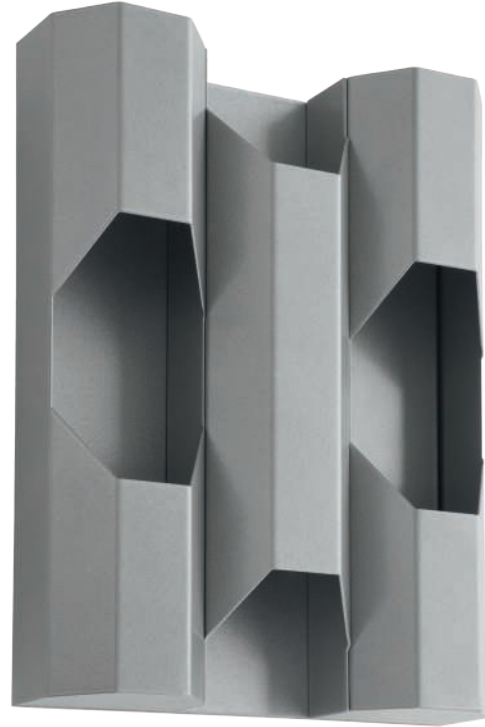

98841



99689 GURARE

wall light; steel, black, mocha-coloured
Wandleuchte; Stahl, schwarz, mokkafarben
applique; acier, noir, café

L 125, H 240, A 85

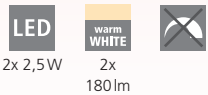

2x 2,5W
2x
180lm



9 002759 996895

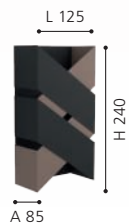

98841 ZINACUA

wall light; steel, silver
Wandleuchte; Stahl, silber
applique; acier, argent

L 225, H 310, A 85

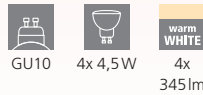

4x 4,5W
4x
345lm



9 002759 988418

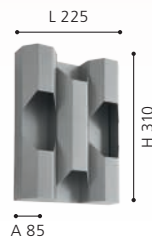



99087

LED

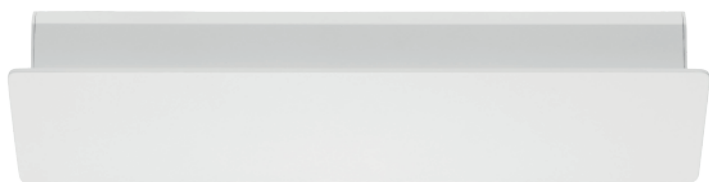

99086

LED



900325

LED

99087 ZUBIALDE

wall light; aluminium, steel, black, white
Wandleuchte; Alu, Stahl, schwarz, weiss
applique; aluminium, acier, noir, blanc

99086 ZUBIALDE

wall light; aluminium, steel, white
Wandleuchte; Alu, Stahl, weiss
applique; aluminium, acier, blanc

ZUBIALDE

The front plate of the luminaire can be swiveled. The light can be adjusted individually.

Die Frontplatte der Leuchte ist schwenkbar. Somit kann das Lichtbild individuell eingestellt werden.

La plaque frontale du luminaire peut être pivotée. La lumière peut être réglée individuellement.

L 360, H 80, A 50

LED

12W

warm WHITE

1550lm



L 360, H 80, A 50

LED

12W

warm WHITE

1550lm



9 002759 990879



9 002759 990862

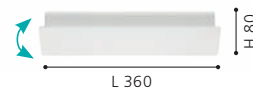



96049

LED



96048

LED

900325 ZUBIALDE

wall light; steel, wood, black, brown
Wandleuchte; Stahl, Holz, schwarz, braun
applique; acier, bois, noir, marron

L 360, H 80, A 50



12W

96049 ONO 2

wall light; aluminium, anthracite / plastic, clear
Wandleuchte; Alu, anthrazit / Kunststoff, klar
applique; aluminium, gris anthracite / plastique, transparent

L 90, H 80, A 130



2x 2,5W 500lm

96048 ONO 2

wall light; aluminium, white / plastic, clear
Wandleuchte; Alu, weiss / Kunststoff, klar
applique; aluminium, blanc / plastique, transparent

L 90, H 80, A 130



2x 2,5W 500lm



9 008606 235360



9 002759 960490



9 002759 960483





98542



98541



98543



98541 MACCARI

wall light; aluminium, steel, white / plastic, transparent
Wandleuchte; Alu, Stahl, weiss / Kunststoff, transparent
applique; aluminium, acier, blanc / plastique, transparent

L 270, H 75, A 130



10W 1300lm



98542 MACCARI

wall light; aluminium, steel, black, gold / plastic, transparent
Wandleuchte; Alu, Stahl, schwarz, gold / Kunststoff, transparent
applique; aluminium, acier, noir, or / plastique, transparent

L 270, H 75, A 130



10W 1300lm



98543 MACCARI

wall light; aluminium, steel, white, satin nickel / plastic, transparent
Wandleuchte; Alu, Stahl, weiss, nickel-matt / Kunststoff, transparent
applique; aluminium, acier, blanc, nickel mat / plastique, transparent

L 270, H 75, A 130



10W 1300lm





98544



98545



98544 FELONICHE

wall light; aluminium, white / plastic, transparent
 Wandleuchte; Alu, weiss / Kunststoff, transparent
 applique; aluminium, blanc / plastique, transparent

L 220, H 100, A 75



10W 1300lm



9 002759 985448

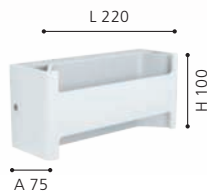

98545 FELONICHE

wall light; aluminium, black, gold / plastic, transparent
 Wandleuchte; Alu, schwarz, gold / Kunststoff, transparent
 applique; aluminium, noir, or / plastique, transparent

L 220, H 100, A 75



10W 1300lm



9 002759 985455

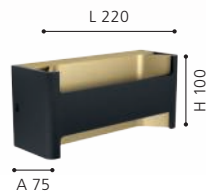



98421



98422



98423



98421 SANIA 4

wall light; aluminium, white
Wandleuchte; Alu, weiss
applique; aluminium, blanc

L 130, H 80, A 90



6W 670lm



9 002759 984212



98422 SANIA 4

wall light; aluminium, white
Wandleuchte; Alu, weiss
applique; aluminium, blanc

L 200, H 80, A 90



10W 1300lm



9 002759 984229

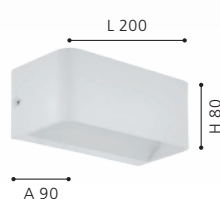

98423 SANIA 4

wall light; aluminium, white
Wandleuchte; Alu, weiss
applique; aluminium, blanc

L 365, H 80, A 90



12W 1400lm



9 002759 984236

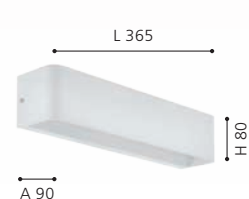



98424



98425



98426



98424 SANIA 4

wall light; aluminium, satin nickel
Wandleuchte; Alu, nickel-matt
applique; aluminium, nickel mat

L 130, H 80, A 90



6W 670lm



9 002759 984243

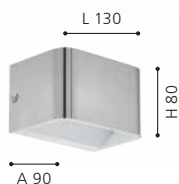

98425 SANIA 4

wall light; aluminium, satin nickel
Wandleuchte; Alu, nickel-matt
applique; aluminium, nickel mat

L 200, H 80, A 90



10W 1300lm



9 002759 984250

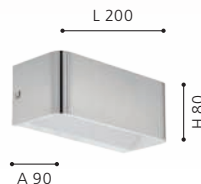

98426 SANIA 4

wall light; aluminium, satin nickel
Wandleuchte; Alu, nickel-matt
applique; aluminium, nickel mat

L 365, H 80, A 90



12W 1400lm



9 002759 984267

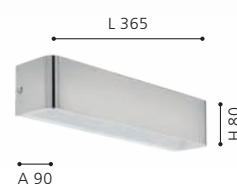



96261

LED



96261 PASSA

wall light; steel, satin nickel, chrome
Wandleuchte; Stahl, nickel-matt, chrom
applique; acier, nickel mat, chrome

L 60, H 170, A 85



GU10



2x 3W



warm
WHITE

2x

250lm



INCL.





96264

LED



95368

LED



95377

LED

96264 PASSA

wall light; steel, satin nickel, chrome
Wandleuchte; Stahl, nickel-matt, chrom
applique; acier, nickel mat, chrome

L 55, H 170, A 85



GU10



2x 3W



warm
WHITE
2x
250lm



9 002759 962647



95368 PASSA

wall light; steel, chrome, white
Wandleuchte; Stahl, chrom, weiss
applique; acier, chrome, blanc

L 60, H 170, A 85



GU10



2x 3W



warm
WHITE
2x
250lm



9 002759 953683



95377 PASSA

wall light; steel, chrome, white
Wandleuchte; Stahl, chrom, weiss
applique; acier, chrome, blanc

L 55, H 170, A 85



GU10



2x 3W



warm
WHITE
2x
250lm



9 002759 953775





95371

LED



95379

LED

95371 PASSA

wall light; steel, brown, copper
Wandleuchte; Stahl, braun, kupfer
applique; acier, marron, cuivre

L 60, H 170, A 85

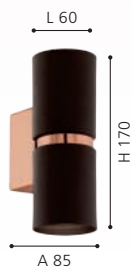
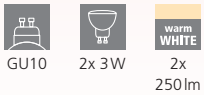

95379 PASSA

wall light; steel, brown, copper
Wandleuchte; Stahl, braun, kupfer
applique; acier, marron, cuivre

L 55, H 170, A 85

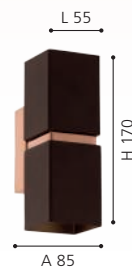
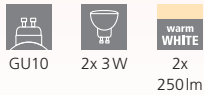

95364 PASSA

wall light; steel, black, gold
Wandleuchte; Stahl, schwarz, gold
applique; acier, noir, or

L 60, H 170, A 85

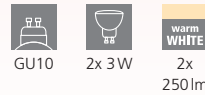



95364

LED



95373

LED

95373 PASSA

wall light; steel, black, gold
Wandleuchte; Stahl, schwarz, gold
applique; acier, noir, or

L 55, H 170, A 85



GU10



2x 3W



warm
WHITE
2x
250lm



9 002759 953737

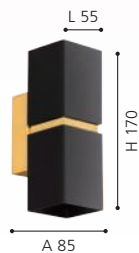



98379



98755



98759

98379 GASCUERIA

wall light; plastic, steel, gold, black
Wandleuchte; Kunststoff, Stahl, gold, schwarz
applique; plastique, acier, or, noir

L 290, H 330, A 130



E27



1x 60W



L 290



H 330

A 130



9 002759 983796

98755 ELIZONDO

wall light; steel, black, gold
Wandleuchte; Stahl, schwarz, gold
applique; acier, noir, or

L 80, H 270, A 115



E14



1x 40W



L 80

H 270

A 115



9 002759 987558

98759 FALICETTO

wall light; steel, black, gold
Wandleuchte; Stahl, schwarz, gold
applique; acier, noir, or

L 160, H 250, A 115



E27



1x 40W



L 160

H 250

A 115



9 002759 987596



900375

900375 HAYES

wall light; steel, black, gold
 Wandleuchte; Stahl, schwarz, gold
 applique; acier, noir, or

L 120, H 225, A 120



HAYES

The golden element of the luminaire can be rotated. This allows the light to be individually adjusted.

Das goldenen Element der Leuchte ist drehbar. Dadurch lässt sich der Lichtschein individuell anpassen.

L'élément doré du luminaire peut être tourné. Cela permet de régler la lumière individuellement.



900343



900518

900343 TANURA

wall light; steel, black
Wandleuchte; Stahl, schwarz
applique; acier, noir

L 245, H 110, A 105



E27



1x 25W



9 008606 243495

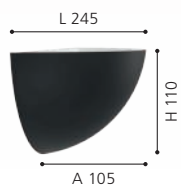

900518 GUANAL

wall light; aluminium, steel, chrome
Wandleuchte; Alu, Stahl, chrom
applique; aluminium, acier, chrome

L 600, B 50, H 60



E27



4x 40W



9 008606 244478

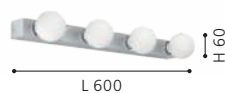

900517 GUANAL

wall light; aluminium, steel, black
Wandleuchte; Alu, Stahl, schwarz
applique; aluminium, acier, noir

L 600, B 50, H 60



E27



4x 40W



9 008606 244461





900517



98656



98657



98656 MONGODIO 1

wall / ceiling light; steel, white / plastic, white
Wand- / Deckenleuchte; Stahl, weiss / Kunststoff, weiss
applique / plafonnier; acier, blanc / plastique, blanc

H 35, Ø 200



8,6W 950lm



9 002759 986568



98657 MONGODIO 1

wall / ceiling light; steel, white / plastic, white
Wand- / Deckenleuchte; Stahl, weiss / Kunststoff, weiss
applique / plafonnier; acier, blanc / plastique, blanc

H 35, Ø 250



11,4W 1300lm



9 002759 986575





98676

LED

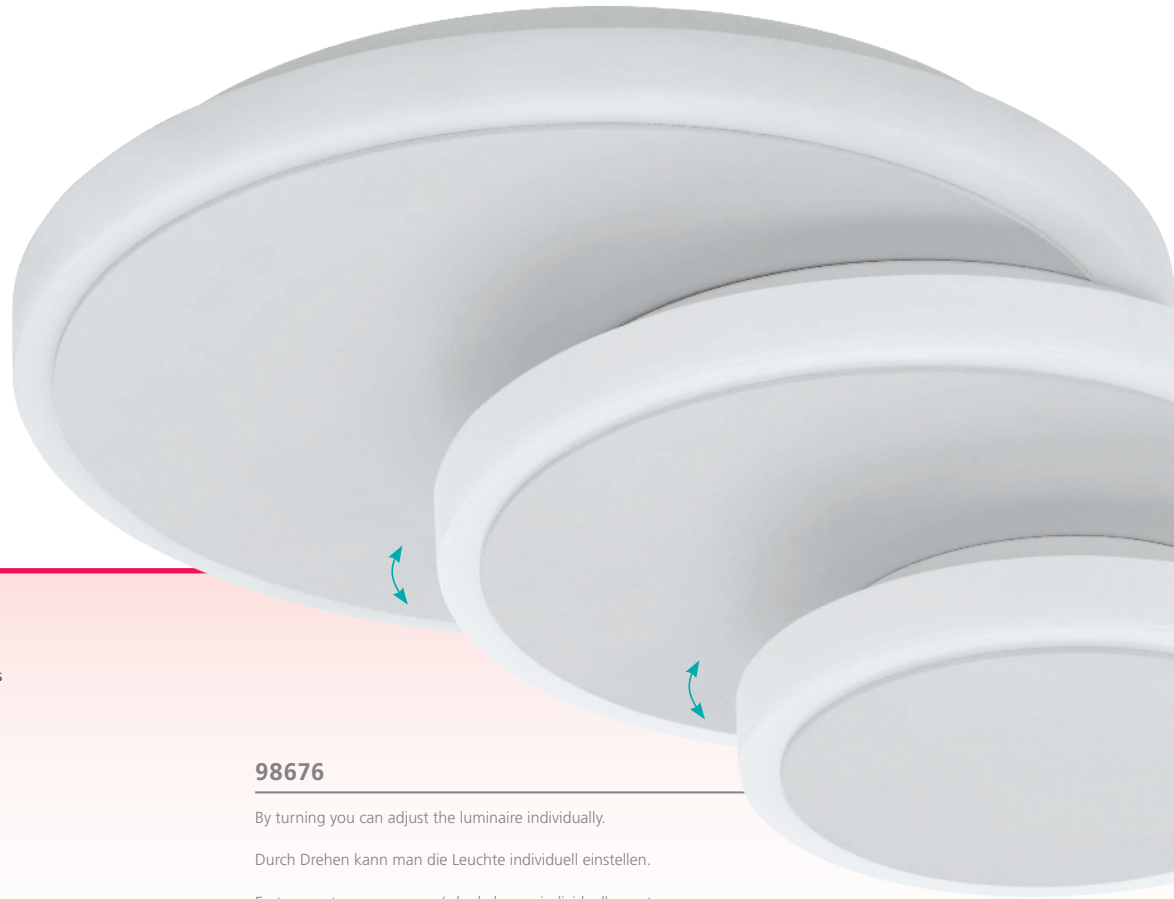

98676 ELGVERO

wall / ceiling light; steel, white / plastic, white
 Wand- / Deckenleuchte; Stahl, weiss / Kunststoff, weiss
 applique / plafonnier; acier, blanc / plastique, blanc

H 100, Ø 250

LED	warm WHITE	LED	warm WHITE	LED
6,5W	750lm	8,6W	950lm	13W

warm WHITE		
1500lm		

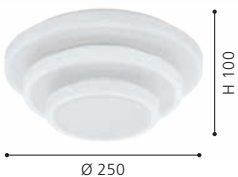

98676

By turning you can adjust the luminaire individually.

Durch Drehen kann man die Leuchte individuell einstellen.

En tournant, vous pouvez régler la lampe individuellement.



30658

LED



30659

LED



33941

LED

30658 CADEGAL

ceiling light; steel, black / plastic, white
Deckenleuchte; Stahl, schwarz / Kunststoff, weiss
plafonnier; acier, noir / plastique, blanc

L 200, B 200, H 50

LED

neutral
WHITE



7,8W

1200lm

30659 CADEGAL

ceiling light; steel, black / plastic, white
Deckenleuchte; Stahl, schwarz / Kunststoff, weiss
plafonnier; acier, noir / plastique, blanc

H 50, Ø 200

LED

neutral
WHITE



7,8W

1100lm

33941 CADEGAL

ceiling light; steel, white / plastic, white
Deckenleuchte; Stahl, weiss / Kunststoff, weiss
plafonnier; acier, blanc / plastique, blanc

L 200, B 200, H 50

LED

neutral
WHITE



7,8W

1200lm



9 002759 306588

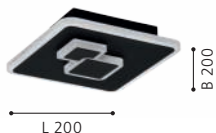

9 002759 306595

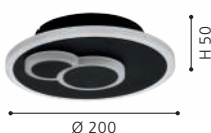

9 002759 339418

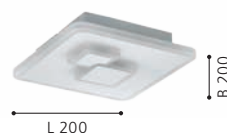

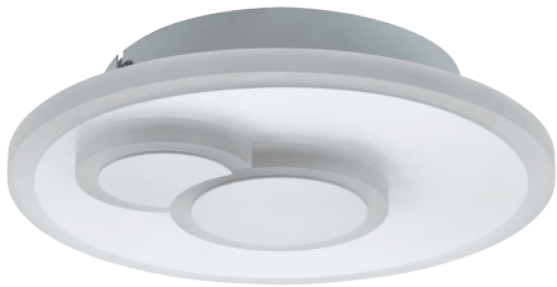

33942

LED



33964

LED



33942 CADEGAL

ceiling light; steel, white / plastic, white
Deckenleuchte; Stahl, weiss / Kunststoff, weiss
plafonnier; acier, blanc / plastique, blanc

H 50, Ø 200



7,8W 1100lm

33964 REMIDOS

ceiling light; steel, white / plastic, white
Deckenleuchte; Stahl, weiss / Kunststoff, weiss
plafonnier; acier, blanc / plastique, blanc

H 90, Ø 400



18,5W 2600lm

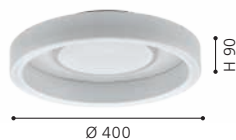



98888



96037



96038



98888 METRASS

wall light; aluminium, black / plastic, satined
Wandleuchte; Alu, schwarz / Kunststoff, satiniert
applique; aluminium, noir / plastique, satiné

L 200, H 105, A 60



1x 5,6W 680lm

96037 METRASS

wall light; aluminium, white / plastic, satined
Wandleuchte; Alu, weiss / Kunststoff, satiniert
applique; aluminium, blanc / plastique, satiné

L 200, H 105, A 60



1x 5,6W 680lm

96038 METRASS

wall light; aluminium, satin nickel / plastic, satined
Wandleuchte; Alu, nickel-matt / Kunststoff, satiniert
applique; aluminium, nickel mat / plastique, satiné

L 200, H 105, A 60



1x 5,6W 680lm



9 002759 988883

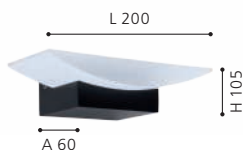

9 002759 960377

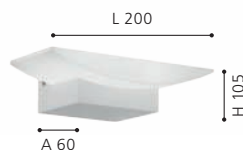

9 002759 960384

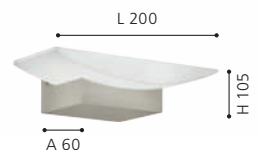



96042



96043



96042 METRASS 2

wall / ceiling light; aluminium, white / plastic, satined
Wand- / Deckenleuchte; Alu, weiss / Kunststoff, satiniert
applique / plafonnier; aluminium, blanc / plastique, satiné

L 170, H 200, A 55



2x 4,5W 960lm



9 002759 960421

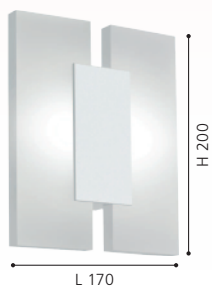

96043 METRASS 2

wall / ceiling light; aluminium, satin nickel / plastic, satined
Wand- / Deckenleuchte; Alu, nickel-matt / Kunststoff, satiniert
applique / plafonnier; aluminium, nickel mat / plastique, satiné

L 170, H 200, A 55



2x 4,5W 960lm



9 002759 960438





96039

LED



96041



96039 METRASS 1

wall light; aluminium, white / plastic, satined
 Wandleuchte; Alu, weiss / Kunststoff, satiniert
 applique; aluminium, blanc / plastique, satiné

L 130, H 130, A 50



1x 4,5W 480lm



9 002759 960391



96041 METRASS 1

wall light; aluminium, satin nickel / plastic, satined
 Wandleuchte; Alu, nickel-matt / Kunststoff, satiniert
 applique; aluminium, nickel mat / plastique, satiné

L 130, H 130, A 50



1x 4,5W 480lm



9 002759 960414





99606

LED



99607

LED

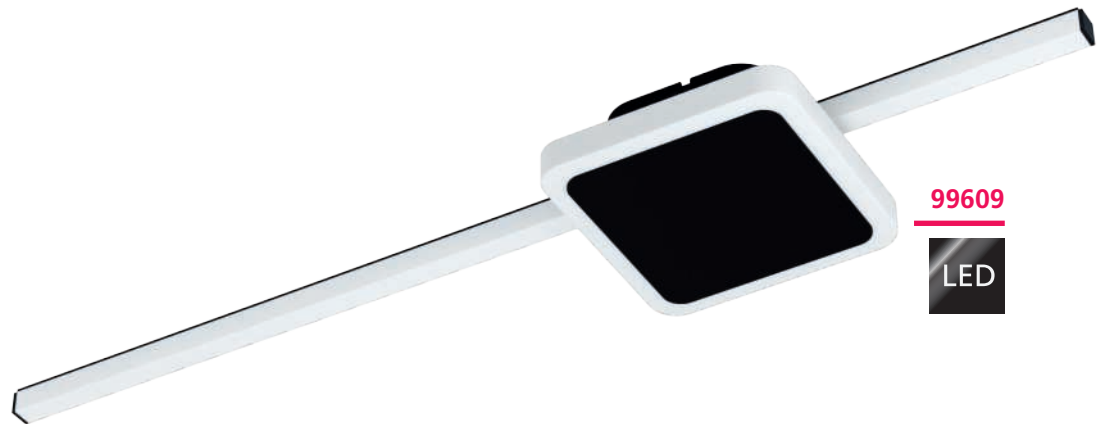

99609

LED

99606 SARGINTO

wall / ceiling light; steel, white / plastic, white
Wand- / Deckenleuchte; Stahl, weiss / Kunststoff, weiss
applique / plafonnier; acier, blanc / plastique, blanc

L 590, B 140, H 45

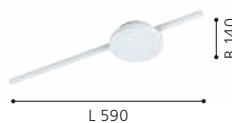

99607 SARGINTO

wall / ceiling light; steel, white / plastic, white
Wand- / Deckenleuchte; Stahl, weiss / Kunststoff, weiss
applique / plafonnier; acier, blanc / plastique, blanc

L 590, B 130, H 45

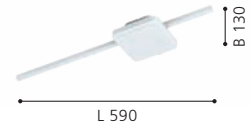



99608

LED

99609 SARGINTO

wall / ceiling light; steel, black / plastic, white
Wand- / Deckenleuchte; Stahl, schwarz / Kunststoff, weiss
applique / plafonnier; acier, noir / plastique, blanc

L 590, B 130, H 45



99608 SARGINTO

wall / ceiling light; steel, black / plastic, white
Wand- / Deckenleuchte; Stahl, schwarz / Kunststoff, weiss
applique / plafonnier; acier, noir / plastique, blanc

L 590, B 140, H 45

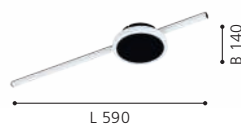

BATH & MIRROR LUMINAIRES

BAD- & SPIEGELLEUCHTEN

LUMINAIRES DE BAIN & MIROIR

PURE RELAXATION

Turn your bathroom into your personal wellness oasis. Trendy bathroom and mirror luminaires give a pleasant light and ensure relaxation and comfort.

ENTSPANNUNG PUR

Verwandeln Sie Ihr Badezimmer in eine persönliche Wohlfühloase. Trendige Bad- und Spiegelleuchten spenden ein angenehmes Licht und sorgen für Entspannung und Ihr Wohlbefinden.



DE LA PURE DÉTENTE

Transformez votre salle de bains en un îlot personnel de bien-être. Des éclairages à la mode de miroirs et de bain confèrent une lumière agréable et vous assurent de la détente et du bien-être.



OVERVIEW

BATH & MIRROR LUMINAIRES

 AMEZOLA p. 600	 SAN PERI 1 p. 601	 TAMARA 1 p. 602-603	 ALMONTE p. 604	 TOLORICO p. 606	 PALMITAL p. 608-609	 MOSIANO p. 609	 WASAO 1 p. 609
 BARI-M p. 610	 FRANIA p. 610, 612	 FRANIA-S p. 611	 MANILVA 1 p. 612	 PINETTO p. 614-615	 LED PALERMO p. 615	 LED CARPI p. 616-617	 FUEVA 5 p. 618-626
 ROMENDO 1 p. 628-629	 SIDERNO p. 630	 SANIA 5 p. 630-631	 GEMILIANA p. 632	 VERDELLO p. 632-633	 ALCUDIA p. 633	 CABUS p. 634-635	 CALNOVA p. 635
 TORRETTA p. 635	 TRAGACETE 1 p. 636-637	 GITA 2 p. 638	 TABIANO p. 641	 VADUMI p. 642	 PANDELLA 1 p. 644-647	 PANDELLA 2 p. 644, 648	 VINCHIO p. 648
 PALMERA p. 650	 ZOLA p. 650	 BARI 1 p. 651	 STICKER p. 651	 BUENAVISTA p. 652	 BUENAVISTA 1 p. 654	 BUENAVISTA 2 p. 654-655	
 TABIANO-Z p. 49	 JUAREZA-Z p. 49	 FUEVA-Z p. 68-79					

You can also find bathroom and mirror lights in EGLO connect.Z.
 Bad und Spiegelleuchten finden sie auch in EGLO connect.Z.
 Vous pouvez également trouver des lampes de salle de bain et de miroir dans EGLO connect.Z.



This product is available in different colors and shapes./ Dieser Artikel ist in unterschiedlichen Farben und Formen verfügbar.
 Cet article est disponible en différentes couleurs et formes.

COLOUR RENDERING INDEX

FARBWIEDERGABE-INDEX

L'INDICE DE RESTITUTION DE COULEURS

QUALITY CRITERION COLOUR RENDERING

The colour rendering index Ra describes the colour rendering quality of lamps. The higher the Ra value, the less will the artificial light change the colour of an object. The maximum Ra value (e.g. the Ra value of the sun) is 100.

Therefore, lamps with an Ra above 90 will make you look better.

Lamps with an Ra value above 90 are marked with this button: 

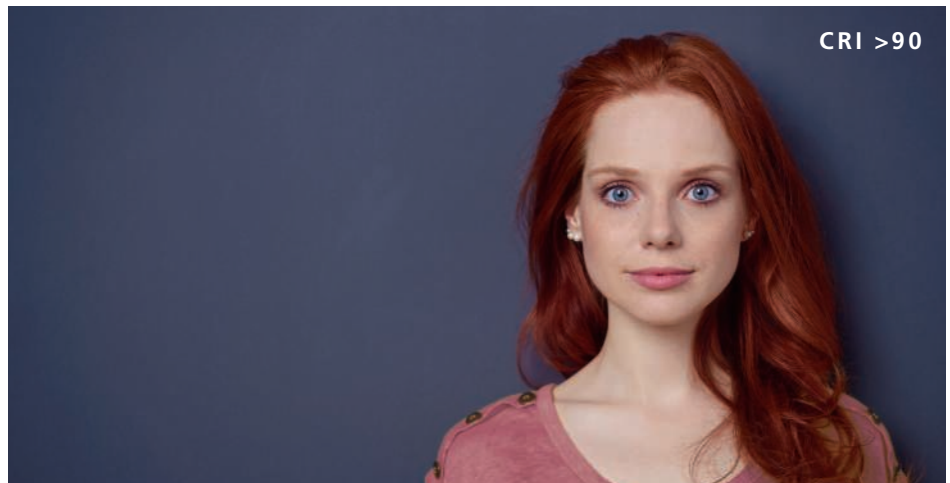

QUALITÄTSKRITERIUM FARBWIEDERGABE

Mit dem Farbwiedergabe-Index Ra wird die Qualität der Farbwiedergabe von Leuchten beschrieben. Je höher der Ra-Wert ist, desto weniger verfälscht das künstliche Licht die Farbe von Objekten. Der maximale Ra-Wert (z.B. der Ra-Wert der Sonne) ist 100.

Leuchten mit Ra >90 lassen Sie somit besser aussehen.

Leuchten die einen Ra-Wert von >90 haben, sind mit diesem Button gekennzeichnet: 

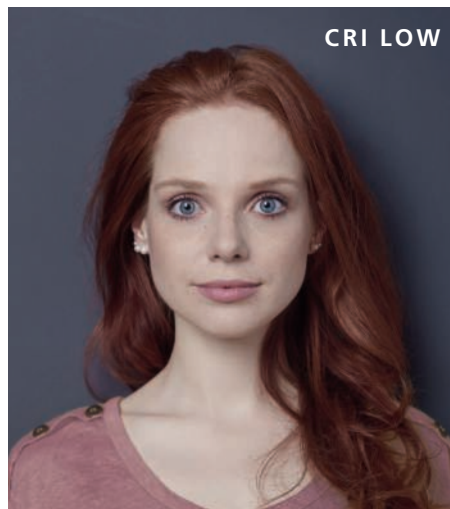

CRITÈRE DE QUALITÉ INDIQUANT LA RESTITUTION DES COULEURS

L'indice de restitution de couleurs Ra décrit la qualité de restitution des éclairages. Plus la valeur Ra est élevée, moins la lumière artificielle falsifie la couleur des objets. La valeur Ra maximale (par ex. la valeur Ra du soleil) est 100.

Ainsi, favorisez des lampes avec une valeur Ra > 90.

Les lampes ayant une valeur Ra > 90 sont identifiées par ce bouton: 



AMEZOLA



99124



99123



99122

99123 AMEZOLA

wall light; steel, black / glass, clear
Wandleuchte; Stahl, schwarz / Glas, klar
applique; acier, noir / verre, transparent

L 110, H 260, A 100



E27

1x 60W

IP44



9 002759 991234



A 100

99124 AMEZOLA

wall light; steel, black / glass, clear
Wandleuchte; Stahl, schwarz / Glas, klar
applique; acier, noir / verre, transparent

L 110, H 380, A 100



E27

2x 60W

IP44



9 002759 991241

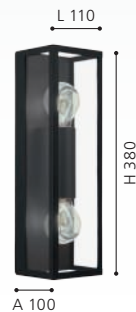

A 100

99122 AMEZOLA

wall / ceiling light; steel, black / glass, clear
Wand- / Deckenleuchte; Stahl, schwarz / Glas, klar
applique / plafonnier; acier, noir / verre, transparent

L 290, H 290, A 130



E27

2x 40W

IP44



9 002759 991227



L 290



900428

LED

900428 SAN PERI 1

wall light; steel, black, white
Wandleuchte; Stahl, schwarz, weiss
applique; acier, noir, blanc

L 130, H 180, A 160



GU10



1x 3W



1x
warm
WHITE



IP44



9 008606 243877



INCL.





95994

LED



95993

LED



95995

LED

95993 TAMARA 1

spot; steel, glass, white, chrome
Spot; Stahl, Glas, weiss, chrom
spot; acier, verre, blanc, chrome

L 120, B 120



95994 TAMARA 1

spot; steel, glass, white, chrome
Spot; Stahl, Glas, weiss, chrom
spot; acier, verre, blanc, chrome

L 460, B 70

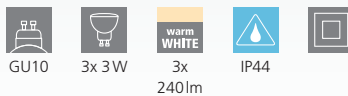

95995 TAMARA 1

spot; steel, glass, white, chrome
Spot; Stahl, Glas, weiss, chrom
spot; acier, verre, blanc, chrome

L 240, B 260

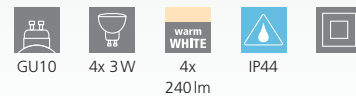



33677

LED



33678

LED

33677 TAMARA 1

spot; steel, black, chrome / glass, clear
 Spot; Stahl, schwarz, chrom / Glas, klar
 spot; acier, noir, chrome / verre, transparent

L 120, B 120

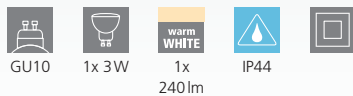

GU10 1x 3W 1x warm WHITE 240lm IP44



9 002759 336776



33678 TAMARA 1

spot; steel, black, chrome / glass, clear
 Spot; Stahl, schwarz, chrom / Glas, klar
 spot; acier, noir, chrome / verre, transparent

L 240, B 260

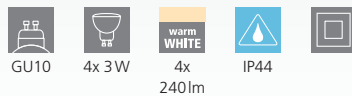

GU10 4x 3W 4x warm WHITE 240lm IP44



9 002759 336783

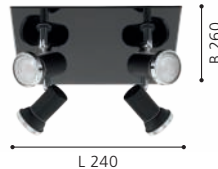

DESIGN
HIGHLIGHT
DETAIL



94879

LED



97699

LED

94879 ALMONTE

wall light; steel, chrome / crystal, clear
Wandleuchte; Stahl, chrom / Kristall, klar
applique; acier, chrome / cristal, transparent

L 110, H 230, A 170



9 002759 948795



97699 ALMONTE

ceiling light; steel, chrome / crystal, clear
Deckenleuchte; Stahl, chrom / Kristall, klar
plafonnier; acier, chrome / cristal, transparent

H 300, Ø 500



9 002759 976996

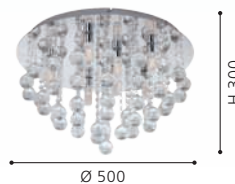

94878 ALMONTE

ceiling light; steel, chrome / crystal, clear
Deckenleuchte; Stahl, chrom / Kristall, klar
plafonnier; acier, chrome / cristal, transparent

H 230, Ø 350



9 002759 948788

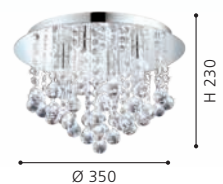



94878

LED





TOLORICO

These luminaires come with high quality glass crystals.

Diese Leuchten sind mit hochwertigen Glaskristallen ausgestattet.

Ces luminaires viennent avec des cristaux de verre de haute qualité.



97054

LED



97055

LED

97054 TOLORICO

wall / ceiling light; stainless steel, chrome / plastic, crystal, clear
Wand- / Deckenleuchte; Edelstahl, chrom / Kunststoff, Kristall, klar

applique / plafonnier; acier inoxydable, chrome / plastique, cristal, transparent

L 350, B 100, H 70



8 W



1000 lm



IP44



97055 TOLORICO

wall / ceiling light; stainless steel, chrome / plastic, crystal, clear
Wand- / Deckenleuchte; Edelstahl, chrom / Kunststoff, Kristall, klar

applique / plafonnier; acier inoxydable, chrome / plastique, cristal, transparent

L 570, B 100, H 75



20,5 W



2700 lm



IP44



97056 TOLORICO

wall / ceiling light; stainless steel, chrome / plastic, crystal, clear
Wand- / Deckenleuchte; Edelstahl, chrom / Kunststoff, Kristall, klar

applique / plafonnier; acier inoxydable, chrome / plastique, cristal, transparent

L 350, B 350, H 75



22 W



3000 lm



IP44



9 002759 970543



9 002759 970550



9 002759 970567





97056

LED



97965

LED

97965 PALMITAL

wall / ceiling light; aluminium, steel, chrome / plastic, clear
Wand- / Deckenleuchte; Alu, Stahl, chrom / Kunststoff, klar
applique / plafonnier; aluminium, acier, chrome / plastique,
transparent

L 880, B 100, H 90



2x 11 W



2700 lm



IP44



9 002759 979652

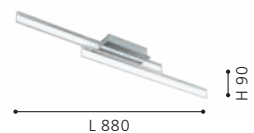



97966



94626



94884



97966 PALMITAL

wall light; aluminium, steel, chrome / plastic, clear
Wandleuchte; Alu, Stahl, chrom / Kunststoff, klar
applique; aluminium, acier, chrome / plastique, transparent

L 595, H 80, A 65



1x 11 W 1350 lm

94626 MOSIANO

wall / ceiling light; stainless steel, chrome / glass opal-matt, white
Wand- / Deckenleuchte; Edelstahl, chrom / Glas opal-matt, weiss
applique / plafonnier; acier inoxydable, chrome / verre opale mat, blanc

H 115, Ø 110



1x 3,3 W 340 lm

94884 WASAO 1

wall / ceiling light; stainless steel, chrome / glass painted, white
Wand- / Deckenleuchte; Edelstahl, chrom / Glas lackiert, weiss
applique / plafonnier; acier inoxydable, chrome / verre laqué, blanc

L 320, B 320, H 60



4x 5,4 W 2040 lm



9 002759 979669



9 002759 946265



9 002759 948849

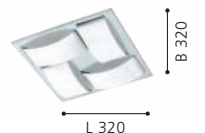



97531



97531



97884

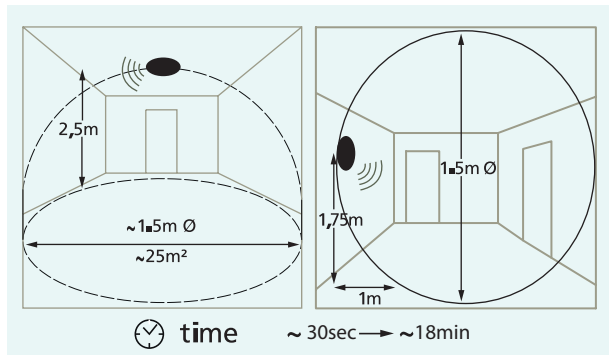

97531

This luminaire comes with an integrated motion sensor.
The sensor is mounted invisibly behind the glass.

Diese Leuchte ist mit einem integrierten Bewegungssensor ausgestattet.
Der Sensor ist unsichtbar hinter dem Glas befestigt.

Ce luminaire vient avec un capteur de mouvement intégré.
Le capteur est attaché invisiblement derrière le verre.

97531 BARI-M

ceiling light; plastic, white / glass, white
Deckenleuchte; Kunststoff, weiss / Glas, weiss
plafonnier; plastique, blanc / verre, blanc

H 110, Ø 275



97884 FRANIA

wall / ceiling light; steel, white / plastic, white
Wand- / Deckenleuchte; Stahl, weiss / Kunststoff, weiss
applique / plafonnier; acier, blanc / plastique, blanc

H 70, Ø 330



9 002759 975319



9 002759 978846





900619



900364



900363



900619 FRANIA-S

wall / ceiling light; steel, white / plastic with crystal effect, white
Wand- / Deckenleuchte; Stahl, weiss / Kunststoff m.Kristalleffekt, weiss
applique / plafonnier; acier, blanc / plastique avec effet cristal, blanc

H 55, Ø 310



18W 1850lm

900363 FRANIA-S

wall / ceiling light; steel, white / plastic with crystal effect, white
Wand- / Deckenleuchte; Stahl, weiss / Kunststoff m.Kristalleffekt, weiss
applique / plafonnier; acier, blanc / plastique avec effet cristal, blanc

H 55, Ø 310



18W 1850lm

900364 FRANIA-S

wall / ceiling light; steel, white / plastic with crystal effect, white
Wand- / Deckenleuchte; Stahl, weiss / Kunststoff m.Kristalleffekt, weiss
applique / plafonnier; acier, blanc / plastique avec effet cristal, blanc

L 330, B 330, H 70



14,6W 1600lm



9 008606 245161



9 008606 234455

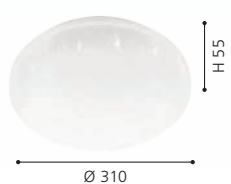

9 008606 234462





97885

LED



96231

LED

97885 FRANIA

wall / ceiling light; steel, white / plastic, white
Wand- / Deckenleuchte; Stahl, weiss / Kunststoff, weiss
applique / plafonnier; acier, blanc / plastique, blanc

L 330, B 330, H 70



14,6W 1600lm

96231 MANILVA 1

wall light; steel, satin nickel / plastic, white
Wandleuchte; Stahl, nickel-matt / Kunststoff, weiss
applique; acier, nickel mat / plastique, blanc

L 290, B 290, H 70



4x 3,6W 1480lm

96229 MANILVA 1

wall light; steel, chrome / plastic, white
Wandleuchte; Stahl, chrom / Kunststoff, weiss
applique; acier, chrome / plastique, blanc

L 290, B 290, H 70



4x 3,6W 1480lm



9 002759 978853



9 002759 962319



9 002759 962296





96229

LED



900366

LED



900366 PINETTO

wall / ceiling light; steel, white / plastic, white, black
Wand- / Deckenleuchte; Stahl, weiss / Kunststoff, weiss, schwarz
applique / plafonnier; acier, blanc / plastique, blanc, noir

H 65, Ø 340

LED

18W

neutral
WHITE

1850lm



IP44



9 008606 235971





900365

LED



94998

LED



94999

LED

900365 PINETTO

wall / ceiling light; steel, white / plastic, white, chrome
Wand- / Deckenleuchte; Stahl, weiss / Kunststoff, weiss, chrom
applique / plafonnier; acier, blanc / plastique, blanc, chrome

H 65, Ø 340



18W 1850lm

94998 LED PALERMO

wall / ceiling light; steel, chrome / satin glass, white painted
Wand- / Deckenleuchte; Stahl, chrom / Glas satiniert, weiss
lackiert
applique / plafonnier; acier, chrome / verre satiné, blanc laqué

H 60, Ø 225



3x 3,6W 1110lm

94999 LED PALERMO

wall / ceiling light; steel, chrome / satin glass, white painted
Wand- / Deckenleuchte; Stahl, chrom / Glas satiniert, weiss
lackiert
applique / plafonnier; acier, chrome / verre satiné, blanc laqué

H 75, Ø 300



3x 5,7W 2100lm



9 008606 235964

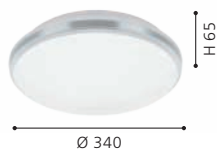

9 002759 949983



9 002759 949990





33682



94967



95282



33682 LED CARPI

wall / ceiling light; steel, black, white / plastic, white
Wand- / Deckenleuchte; Stahl, schwarz, weiss / Kunststoff, weiss
applique / plafonnier; acier, noir, blanc / plastique, blanc

Ø 300, A 75



3x 11 W
3x
950 lm

95282 LED CARPI

wall / ceiling light; steel, white, chrome / plastic, white
Wand- / Deckenleuchte; Stahl, weiss, chrom / Kunststoff, weiss
applique / plafonnier; acier, blanc, chrome / plastique, blanc

Ø 300, A 75



3x 3,6 W
1110 lm

94967 LED CARPI

wall / ceiling light; steel, aluminium, white, brushed aluminium / plastic, white
Wand- / Deckenleuchte; Stahl, Alu, weiss, alu-gebürstet / Kunststoff, weiss
applique / plafonnier; acier, aluminium, blanc, aluminium brossé / plastique, blanc
Ø 300, A 75



3x 3,6 W
1110 lm



9 002759 336820



Ø 300



9 002759 952822



Ø 300



9 002759 949679



Ø 300



900369

LED



95283

LED



900369 LED CARPI

ceiling light; steel, brushed brass, white / plastic, white
 Deckenleuchte; Stahl, messing-gebürstet, weiss / Kunststoff, weiss
 plafonnier; acier, laiton brossé, blanc / plastique, blanc

Ø 300, A 75



3x 3,6W 1110lm

95283 LED CARPI

wall / ceiling light; steel, white, chrome / plastic, white
 Wand- / Deckenleuchte; Stahl, weiss, chrom / Kunststoff, weiss
 applique / plafonnier; acier, blanc, chrome / plastique, blanc

Ø 385, A 75



3x 7,3W 2220lm



9 008606 240623



Ø 300



9 002759 952839



Ø 385



99202, 99203, 99206, 99207

These luminaires are protected against splash water.

Diese Leuchten sind gegen Spritzwasser geschützt.

Les luminaires sont protégées contre les éclaboussures d'eau.



IP44

	0	1	2	3
EU	X	X	✓	✓
FR	X	X	X	✓



99202

LED

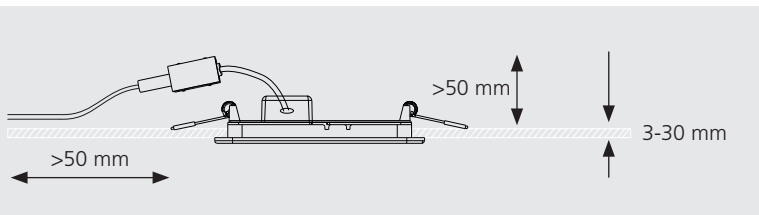

99202, 99203, 99206, 99207

Slim design and minimal installation depth. This makes it ideal for ceiling constructions with little space. Easy installation / replacement of the lights with practical connectors.

Schlanke Bauform und minimale Einbautiefe. Dadurch ideal für Deckenkonstruktionen mit wenig Platz. Einfache Montage / Austausch der Leuchten durch praktischen Verbinder.

Conception mince et profondeur d'installation minimale. Cela le rend idéal pour les constructions de plafond avec peu d'espace. Installation / remplacement facile des lumières avec des connecteurs pratiques.

99202 FUEVA 5

recessed light; steel, white / plastic, white
Einbauleuchte; Stahl, weiss / Kunststoff, weiss
luminaire encastrable; acier, blanc / plastique, blanc

Ø 86, ET 26



2,7W 330lm

Ø 75 IP44



9 002759 992026



Ø 86

99203 FUEVA 5

recessed light; steel, white / plastic, white
Einbauleuchte; Stahl, weiss / Kunststoff, weiss
luminaire encastrable; acier, blanc / plastique, blanc

Ø 166, ET 26



11W 1350lm

Ø 155 IP44



9 002759 992033



Ø 166

99206 FUEVA 5

recessed light; steel, white / plastic, white
Einbauleuchte; Stahl, weiss / Kunststoff, weiss
luminaire encastrable; acier, blanc / plastique, blanc

Ø 86, ET 26



2,7W 330lm

Ø 75 IP44



9 002759 992064



Ø 86



99203

LED



99206

LED

99207 FUEVA 5

recessed light; steel, white / plastic, white
Einbauleuchte; Stahl, weiss / Kunststoff, weiss
luminaire encastrable; acier, blanc / plastique, blanc

Ø 166, ET 26



99207

LED

99204, 99205, 99208, 99209

These luminaires are protected against splash water.

Diese Leuchten sind gegen Spritzwasser geschützt.

Les luminaires sont protégées contre les éclaboussures d'eau.



	0	1	2	3
EU	X	X	✓	✓
FR	X	X	X	✓



99208



99209



99204, 99205, 99208, 99209

Slim design and minimal installation depth. This makes it ideal for ceiling constructions with little space. Easy installation / replacement of the lights with practical connectors.

Schlanke Bauform und minimale Einbautiefe. Dadurch ideal für Deckenkonstruktionen mit wenig Platz. Einfache Montage / Austausch der Leuchten durch praktischen Verbinder.

Conception mince et profondeur d'installation minimale. Cela le rend idéal pour les constructions de plafond avec peu d'espace. Installation / remplacement facile des lumières avec des connecteurs pratiques.

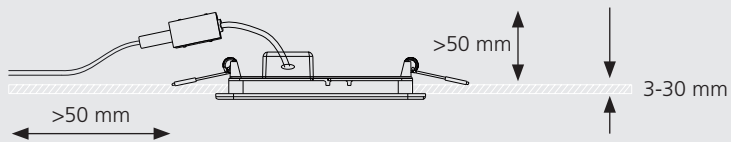

99208 FUEVA 5

recessed light; steel, chrome / plastic, white
Einbauleuchte; Stahl, chrom / Kunststoff, weiss
luminaire encastrable; acier, chrome / plastique, blanc

Ø 86, ET 26



99209 FUEVA 5

recessed light; steel, chrome / plastic, white
Einbauleuchte; Stahl, chrom / Kunststoff, weiss
luminaire encastrable; acier, chrome / plastique, blanc

Ø 166, ET 26



99205 FUEVA 5

recessed light; steel, chrome / plastic, white
Einbauleuchte; Stahl, chrom / Kunststoff, weiss
luminaire encastrable; acier, chrome / plastique, blanc

Ø 166, ET 26





99205

LED



99204

LED

99204 FUEVA 5

recessed light; steel, chrome / plastic, white
Einbauleuchte; Stahl, chrom / Kunststoff, weiss
luminaire encastrable; acier, chrome / plastique, blanc

Ø 86, ET 26

LED

2,7W

warm
WHITE

330lm



Ø 75



IP44



9 002759 992040



Ø 86

99211, 99212, 99213, 99214

These luminaires are protected against splash water.

Diese Leuchten sind gegen Spritzwasser geschützt.

Les luminaires sont protégées contre les éclaboussures d'eau.



	0	1	2	3
EU	X	X	✓	✓
FR	X	X	X	✓



99213



99214



99211, 99212, 99213, 99214

Slim design and minimal installation depth. This makes it ideal for ceiling constructions with little space. Easy installation / replacement of the lights with practical connectors.

Schlanke Bauform und minimale Einbautiefe. Dadurch ideal für Deckenkonstruktionen mit wenig Platz. Einfache Montage / Austausch der Leuchten durch praktischen Verbinder.

Conception mince et profondeur d'installation minimale. Cela le rend idéal pour les constructions de plafond avec peu d'espace. Installation / remplacement facile des lumières avec des connecteurs pratiques.

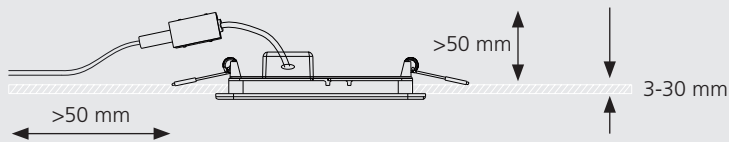

99213 FUEVA 5

recessed light; steel, black / plastic, white
Einbauleuchte; Stahl, schwarz / Kunststoff, weiss
luminaire encastrable; acier, noir / plastique, blanc

Ø 86, ET 26



Ø 86

99214 FUEVA 5

recessed light; steel, black / plastic, white
Einbauleuchte; Stahl, schwarz / Kunststoff, weiss
luminaire encastrable; acier, noir / plastique, blanc

Ø 166, ET 26



Ø 166

99212 FUEVA 5

recessed light; steel, black / plastic, white
Einbauleuchte; Stahl, schwarz / Kunststoff, weiss
luminaire encastrable; acier, noir / plastique, blanc

Ø 166, ET 26



Ø 166



99212

LED



99211

LED

99211 FUEVA 5

recessed light; steel, black / plastic, white
Einbauleuchte; Stahl, schwarz / Kunststoff, weiss
luminaire encastrable; acier, noir / plastique, blanc

Ø 86, ET 26

LED

2,7W

warm
WHITE

330lm



Ø 75



IP44



9 002759 992118



RECESSED



Ø 86



99265



99267



99265 FUEVA 5

surface-mounted light; steel, white / plastic, white
 Aufbauleuchte; Stahl, weiss / Kunststoff, weiss
 luminaire en saillie; acier, blanc / plastique, blanc

H 28, Ø 285



99267 FUEVA 5

surface-mounted light; steel, black / plastic, white
 Aufbauleuchte; Stahl, schwarz / Kunststoff, weiss
 luminaire en saillie; acier, noir / plastique, blanc

H 28, Ø 285



99266 FUEVA 5

surface-mounted light; steel, chrome / plastic, white
 Aufbauleuchte; Stahl, chrom / Kunststoff, weiss
 luminaire en saillie; acier, chrome / plastique, blanc

H 28, Ø 285

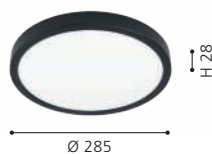



99266





99268



99271



99268 FUEVA 5

surface-mounted light; steel, white / plastic, white
 Aufbauleuchte; Stahl, weiss / Kunststoff, weiss
 luminaire en saillie; acier, blanc / plastique, blanc

L 285, B 285, H 30



20,5W 2400lm

99271 FUEVA 5

surface-mounted light; steel, black / plastic, white
 Aufbauleuchte; Stahl, schwarz / Kunststoff, weiss
 luminaire en saillie; acier, noir / plastique, blanc

L 285, B 285, H 30



20,5W 2400lm

99269 FUEVA 5

surface-mounted light; steel, chrome / plastic, white
 Aufbauleuchte; Stahl, chrom / Kunststoff, weiss
 luminaire en saillie; acier, chrome / plastique, blanc

L 285, B 285, H 30



20,5W 2400lm



9 002759 992682

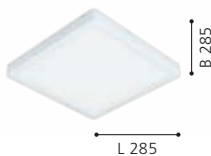

9 002759 992712



9 002759 992699

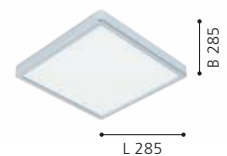



99269

LED





96541 ROMENDO 1

wall light; steel, chrome / plastic, clear, satined
Wandleuchte; Stahl, chrom / Kunststoff, klar, satiniert
applique; acier, chrome / plastique, transparent, satiné

L 70, H 155, A 120

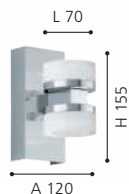
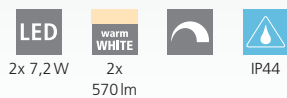

96542 ROMENDO 1

wall light; steel, chrome / plastic, clear, satined
Wandleuchte; Stahl, chrom / Kunststoff, klar, satiniert
applique; acier, chrome / plastique, transparent, satiné

L 300, H 70, A 125

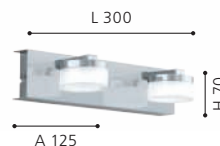
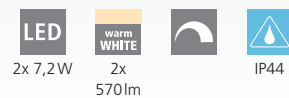

96544 ROMENDO 1

ceiling light; steel, chrome / plastic, clear, satined
Deckenleuchte; Stahl, chrom / Kunststoff, klar, satiniert
plafonnier; acier, chrome / plastique, transparent, satiné

L 320, B 320, H 70

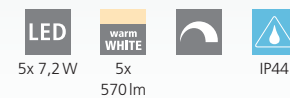



ROMENDO 1

These luminaires are dimmable.

Diese Leuchten sind dimmbar.

Ces luminaires sont graduables.

96543 ROMENDO 1

wall light; steel, chrome / plastic, clear, satined
Wandleuchte; Stahl, chrom / Kunststoff, klar, satiniert
applique; acier, chrome / plastique, transparent, satiné

L 450, H 70, A 125



3x 7,2W



3x
570lm



IP44

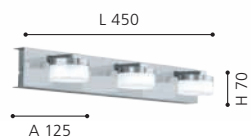

96543

LED



97718



97719

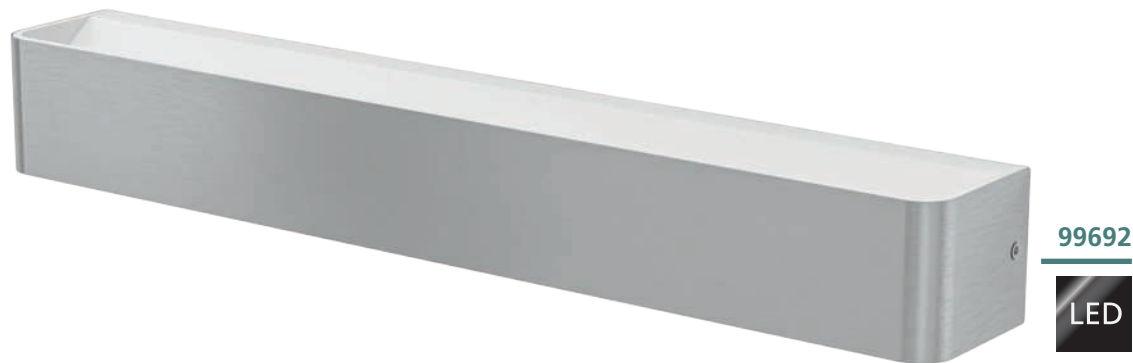

99692



97718 SIDERNO

mirror light; steel, chrome / plastic, satiné
Spiegelleuchte; Stahl, chrom / Kunststoff, satiniert
applique pour miroir; acier, chrome / plastique, satiné

L 350, B 60, A 55



8,3W 900lm

97719 SIDERNO

mirror light; steel, chrome / plastic, satiné
Spiegelleuchte; Stahl, chrom / Kunststoff, satiniert
applique pour miroir; acier, chrome / plastique, satiné

L 580, B 60, A 65



16W 1800lm

99692 SANIA 5

wall light; steel, satin nickel, white / plastic, satiné
Wandleuchte; Stahl, nickel-matt, weiss / Kunststoff, satiniert
applique; acier, nickel mat, blanc / plastique, satiné

L 620, H 80, A 90



26,5W 3200lm



9 002759 977184

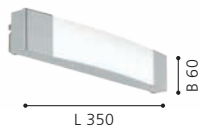

9 002759 977191

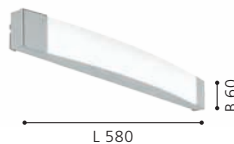

9 002759 996925

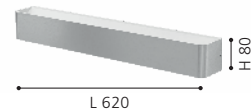



99691

LED

99691 SANIA 5

wall light; steel, black, white / plastic, satined
Wandleuchte; Stahl, schwarz, weiss / Kunststoff, satiniert
applique; acier, noir, blanc / plastique, satiné

L 620, H 80, A 90



26,5W

3200lm

IP44

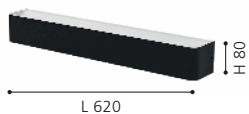



900615

LED



900616

LED



GEMILIANA

The LED profile of this luminaire can be swiveled for direct or indirect light.

Das LED-Profil dieser Leuchte ist schwenkbar für direktes oder indirektes Licht.

Le profil LED de cette luminaire peut être pivoté pour un éclairage direct ou indirect.



900475

LED

900615 GEMILIANA

mirror light; steel, black / plastic, white
Spiegelleuchte; Stahl, schwarz / Kunststoff, weiss
applique pour miroir; acier, noir / plastique, blanc

L 450, H 40, A 100



8,9W



1000lm



IP44



900616 GEMILIANA

mirror light; steel, chrome / plastic, white
Spiegelleuchte; Stahl, chrom / Kunststoff, weiss
applique pour miroir; acier, chrome / plastique, blanc

L 450, H 40, A 100



8,9W



1000lm



IP44



900475 VERDELLO

mirror light; plastic, black, brass / plastic, white
Spiegelleuchte; Kunststoff, schwarz, messing / Kunststoff, weiss
applique pour miroir; plastique, noir, laiton / plastique, blanc

L 600, B 60, H 105



5W



750lm



IP44



9 008606 245123



9 008606 245130



9 008606 244126

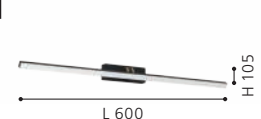



900476



VERDELLO

This luminaire swivels up and down and has a CCT switch on the side.

Die Leuchte ist nach oben und unten schwenkbar und hat einen seitlichen CCT-Schalter.

Cette luminaire pivote de haut en bas et dispose d'un interrupteur CCT sur le côté.



900617



900618



900476 VERDELLO

mirror light; plastic, white, chrome / plastic, white
Spiegelleuchte; Kunststoff, weiss, chrom / Kunststoff, weiss
applique pour miroir; plastique, blanc, chrome / plastique, blanc

L 600, B 60, H 105



900617 ALCUDIA

mirror light; aluminium, steel, black / plastic, satiné
Spiegelleuchte; Alu, Stahl, schwarz / Kunststoff, satiniert
applique pour miroir; aluminium, acier, noir / plastique, satiné

L 420, H 30, A 60



900618 ALCUDIA

mirror light; aluminium, steel, chrome / plastic, satiné
Spiegelleuchte; Alu, Stahl, chrom / Kunststoff, satiniert
applique pour miroir; aluminium, acier, chrome / plastique, satiné

L 420, H 30, A 60



96938

LED



96938 CABUS

wall light; steel, chrome / plastic, satiné
Wandleuchte; Stahl, chrom / Kunststoff, satiniert
applique; acier, chrome / plastique, satiné

L 580, H 45, A 115

LED

4x 4,5W

warm
WHITE

1800lm



IP44

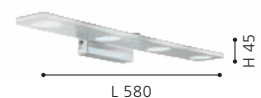



96937



94716



94617



96937 CABUS

wall light; steel, chrome / plastic, satined
Wandleuchte; Stahl, chrom / Kunststoff, satiniert
applique; acier, chrome / plastique, satiné

L 450, H 45, A 115



3x 4,5W 1350lm



9 002759 969370

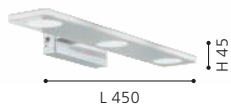

94716 CALNOVA

wall light; steel, satin nickel / satin glass, white
Wandleuchte; Stahl, nickel-matt / Glas satiniert, weiss
applique; acier, nickel mat / verre satiné, blanc

L 600, B 50, A 85



14W 1900lm



9 002759 947163



94617 TORRETTA

mirror light; steel, satin nickel / plastic, white
Spiegelleuchte; Stahl, nickel-matt / Kunststoff, weiss
applique pour miroir; acier, nickel mat / plastique, blanc

L 600, B 40, A 75



14W 1900lm



9 002759 946173

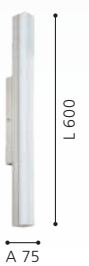



TRAGACETE 1

These luminaires refer to an on / off button directly on the luminaire.

Diese Leuchten verfügen über einen Ein-/Ausschaltknopf direkt an der Leuchte.

Ces luminaires se réfèrent à un bouton marche / arrêt directement sur le luminaire.



99776

LED



99777

LED



99778

LED

99776 TRAGACETE 1

mirror light; plastic, steel, silver, chrome / plastic, white
Spiegelleuchte; Kunststoff, Stahl, silber, chrom / Kunststoff, weiss
applique pour miroir; plastique, acier, argent, chrome / plastique, blanc

L 450, B 45, H 45



7,5W



900lm



IP44



9 002759 997762



99777 TRAGACETE 1

mirror light; plastic, steel, silver, chrome / plastic, white
Spiegelleuchte; Kunststoff, Stahl, silber, chrom / Kunststoff, weiss
applique pour miroir; plastique, acier, argent, chrome / plastique, blanc

L 600, B 45, H 45



15,5W



1900lm



IP44



9 002759 997779



99778 TRAGACETE 1

mirror light; plastic, steel, silver, chrome / plastic, white
Spiegelleuchte; Kunststoff, Stahl, silber, chrom / Kunststoff, weiss
applique pour miroir; plastique, acier, argent, chrome / plastique, blanc

L 770, B 45, H 45



18,5W



2600lm



IP44



9 002759 997786





99339

LED

99339 TRAGACETE 1

mirror light; aluminium, silver, chrome / plastic, white
 Spiegelleuchte; Alu, silber, chrom / Kunststoff, weiss
 applique pour miroir; aluminium, argent, chrome / plastique,
 blanc

L 680, B 55, H 70



15W



1850lm



IP44

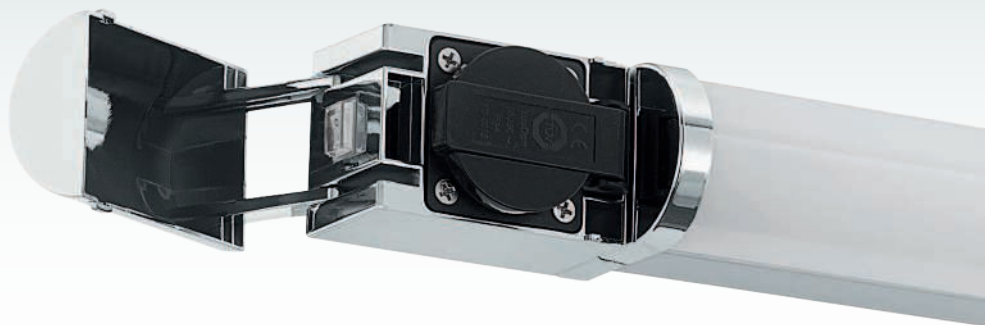

99339

This luminaire has a built-in socket.

Diese Leuchte verfügt über eine eingebaute Steckdose.

Cette luminaire a une douille intégrée.



9 002759 993399

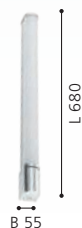

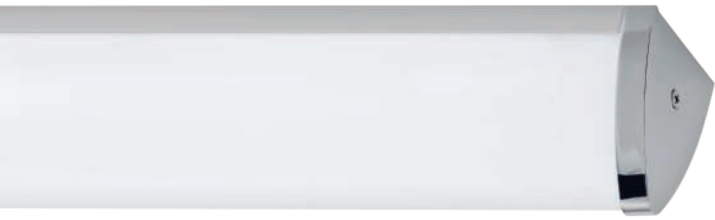

DESIGN
HIGHLIGHT
DETAIL



94712



94713



94712 GITA 2

wall / ceiling light; cast metal, chrome / plastic, white
Wand- / Deckenleuchte; Metallguss, chrom / Kunststoff, weiss
applique / plafonnier; fonte métallique, chrome / plastique,
blanc

L 350, B 75, H 75



8,3W



900lm



IP44



9 002759 947125



94713 GITA 2

wall / ceiling light; cast metal, chrome / plastic, white
Wand- / Deckenleuchte; Metallguss, chrom / Kunststoff, weiss
applique / plafonnier; fonte métallique, chrome / plastique,
blanc

L 600, B 75, H 75



16W



1800lm



IP44



9 002759 947132

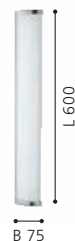

94714 GITA 2

wall / ceiling light; cast metal, chrome / plastic, white
Wand- / Deckenleuchte; Metallguss, chrom / Kunststoff, weiss
applique / plafonnier; fonte métallique, chrome / plastique,
blanc

L 900, B 75, H 75



16W



1800lm



8,3W



900lm



IP44



9 002759 947149

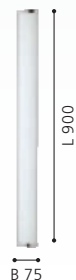



94714

LED



94613

LED





94614



94612



94613 TABIANO

mirror light; steel, chrome / plastic, white
Spiegelleuchte; Stahl, chrom / Kunststoff, weiss
applique pour miroir; acier, chrome / plastique, blanc

L 605, H 70, A 130



3x 3,2W 900lm

94614 TABIANO

mirror light; steel, satin nickel / plastic, white
Spiegelleuchte; Stahl, nickel-matt / Kunststoff, weiss
applique pour miroir; acier, nickel mat / plastique, blanc

L 405, H 70, A 130



2x 3,2W 600lm

94612 TABIANO

mirror light; steel, chrome / plastic, white
Spiegelleuchte; Stahl, chrom / Kunststoff, weiss
applique pour miroir; acier, chrome / plastique, blanc

L 405, H 70, A 130



2x 3,2W 600lm



9 002759 946135



9 002759 946142



9 002759 946128



DESIGN
HIGHLIGHT
DETAIL



97081

LED



97082

LED

97081 VADUMI

wall light; plastic, chrome / plastic, white
Wandleuchte; Kunststoff, chrom / Kunststoff, weiss
applique; plastique, chrome / plastique, blanc

L 400, H 50, A 125



7,5W 850lm

97082 VADUMI

wall light; plastic, chrome / plastic, white
Wandleuchte; Kunststoff, chrom / Kunststoff, weiss
applique; plastique, chrome / plastique, blanc

L 600, H 50, A 125



11,5W 1350lm

97083 VADUMI

wall light; plastic, chrome / plastic, white
Wandleuchte; Kunststoff, chrom / Kunststoff, weiss
applique; plastique, chrome / plastique, blanc

L 780, H 50, A 125



15W 1750lm



9 002759 970819



9 002759 970826

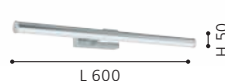

9 002759 970833

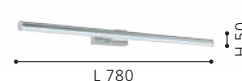



97083

LED





98907

LED



98908

LED



99731

LED

98907 PANDELLA 1

mirror light; aluminium, plastic, black / plastic, white
Spiegelleuchte; Alu, Kunststoff, schwarz / Kunststoff, weiss
applique pour miroir; aluminium, plastique, noir / plastique, blanc

L 400, H 40, A 120



7,4W



900lm



IP44



98908 PANDELLA 1

mirror light; aluminium, plastic, black / plastic, white
Spiegelleuchte; Alu, Kunststoff, schwarz / Kunststoff, weiss
applique pour miroir; aluminium, plastique, noir / plastique, blanc

L 600, H 40, A 120



11W



1350lm



IP44



99731 PANDELLA 2

mirror light; aluminium, plastic, black / plastic, white
Spiegelleuchte; Alu, Kunststoff, schwarz / Kunststoff, weiss
applique pour miroir; aluminium, plastique, noir / plastique, blanc

L 600, H 40, A 120



11W



1400lm



IP44



9 002759 989071



9 002759 989088



9 002759 997311





98677

LED

98677 PANDELLA 1

mirror light; aluminium, plastic, black / plastic, white
 Spiegelleuchte; Alu, Kunststoff, schwarz / Kunststoff, weiss
 applique pour miroir; aluminium, plastique, noir / plastique, blanc

L 780, H 40, A 120

LED

14W

neutral
WHITE

1700lm



IP44



9 002759 986773



DESIGN
HIGHLIGHT
DETAIL



96064

LED

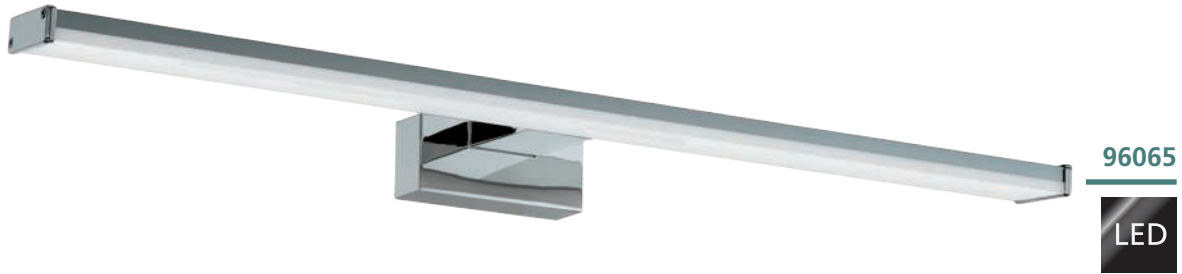

96065

LED



96066

LED

96064 PANDELLA 1

mirror light; aluminium, plastic, chrome, silver / plastic, white
Spiegelleuchte; Alu, Kunststoff, chrom, silber / Kunststoff, weiss
applique pour miroir; aluminium, plastique, chrome, argent /
plastique, blanc

L 400, H 40, A 120



7,4W



900lm



IP44



96065 PANDELLA 1

mirror light; aluminium, plastic, chrome, silver / plastic, white
Spiegelleuchte; Alu, Kunststoff, chrom, silber / Kunststoff, weiss
applique pour miroir; aluminium, plastique, chrome, argent /
plastique, blanc

L 600, H 40, A 120



11W



1350lm



IP44



96066 PANDELLA 1

mirror light; aluminium, plastic, chrome, silver / plastic, white
Spiegelleuchte; Alu, Kunststoff, chrom, silber / Kunststoff, weiss
applique pour miroir; aluminium, plastique, chrome, argent /
plastique, blanc

L 780, H 40, A 120



14W



1700lm



IP44



9 002759 960643



9 002759 960650



9 002759 960667





99297 PANDELLA 1

mirror light; aluminium, plastic, chrome, silver / plastic, white
Spiegelleuchte; Alu, Kunststoff, chrom, silber / Kunststoff, weiss
applique pour miroir; aluminium, plastique, chrome, argent /
plastique, blanc

L 1200, H 40, A 120



13,5W

1750lm

IP44

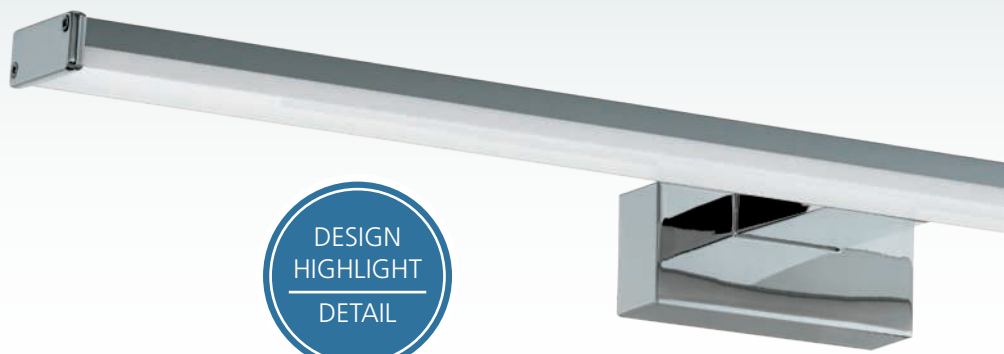



97059

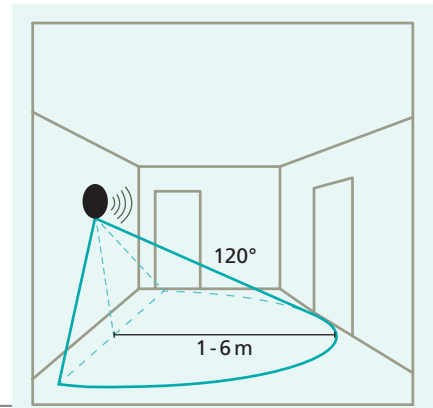

97059

This luminaire comes with an integrated motion sensor. The sensor is mounted invisibly behind the casing.

Diese Leuchte ist mit einem integrierten Bewegungssensor ausgestattet. Der Sensor ist unsichtbar hinter dem Gehäuse befestigt.

Ce luminaire vient avec un capteur de mouvement intégré. Le capteur est attaché invisiblement derrière le boîtier.

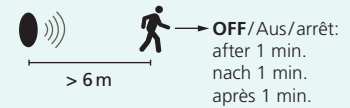
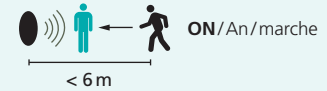

VINCHIO

These luminaires are delivered with a wiring and connection box that is 19.5 mm deep.

Diese Leuchten werden mit einer Verkabelungs- und Anschlussbox mit einer Tiefe von 19,5 mm geliefert.

Cette luminaires sont livré avec un boîtier de câblage et de connexion d'une profondeur de 19,5 mm.



98501



97059 PANDELLA 2

mirror light; plastic, silver, chrome / plastic, white
Spiegelleuchte; Kunststoff, silber, chrom / Kunststoff, weiss
applique pour miroir; plastique, argent, chrome / plastique, blanc

L 400, H 75, A 150



98501 VINCHIO

mirror light; steel, chrome / plastic, white
Spiegelleuchte; Stahl, chrom / Kunststoff, weiss
applique pour miroir; acier, chrome / plastique, blanc

L 400, H 50, A 140



98502 VINCHIO

mirror light; steel, chrome / plastic, white
Spiegelleuchte; Stahl, chrom / Kunststoff, weiss
applique pour miroir; acier, chrome / plastique, blanc

L 600, H 50, A 140





98502

LED

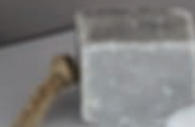

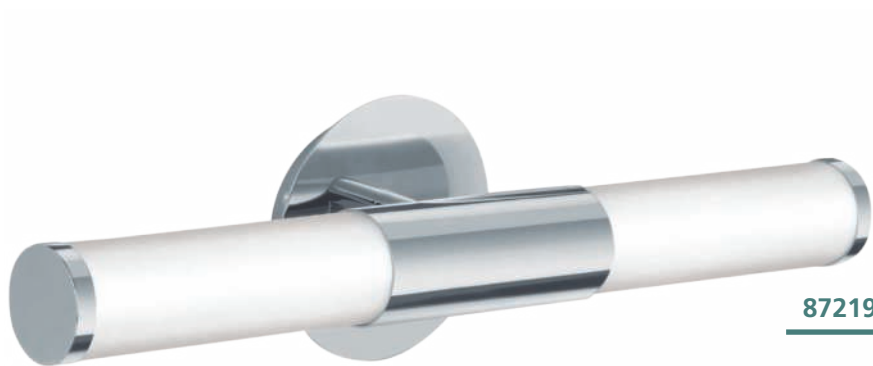

87219



87222



83406



83406 | 87219 | 87222

87219 PALMERA

wall light; steel, chrome / glass opal-matt, white
Wandleuchte; Stahl, chrom / Glas opal-matt, weiss
applique; acier, chrome / verre opale mat, blanc

L 460, A 110



E14



2x 40W



IP44



9 002759 872199



L 460

87222 PALMERA

wall light; steel, satin nickel / glass opal-matt, white
Wandleuchte; Stahl, nickel-matt / Glas opal-matt, weiss
applique; acier, nickel mat / verre opale mat, blanc

L 460, A 110



E14



2x 40W



IP44



9 002759 872229



L 460

83406 ZOLA

wall light; steel / glass opal-matt, white
Wandleuchte; Stahl / Glas opal-matt, weiss
applique; acier / verre opale mat, blanc

L 390, B 80



E14



2x 40W



9 002759 834067



B 80

L 390



94987



85832

94987 BARI 1

mirror light; plastic, white / glass grooved, white
Spiegelleuchte; Kunststoff, weiss / Glas gerillt, weiss
applique pour miroir; plastique, blanc / verre rainuré, blanc

L 350, B 60, A 85



E14 2x 25W



9 002759 949877



85832 STICKER

mirror light; steel, chrome / glass opal-matt, white
Spiegelleuchte; Stahl, chrom / Glas opal-matt, weiss
applique pour miroir; acier, chrome / verre opale mat, blanc

L 70, H 115, A 95

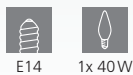

E14 1x 40W



9 002759 858322



94987

This luminaire comes with an integrated power socket.

Diese Leuchte ist mit einer integrierten Steckdose ausgestattet.

Ce luminaire vient avec une prise de courant intégrée.

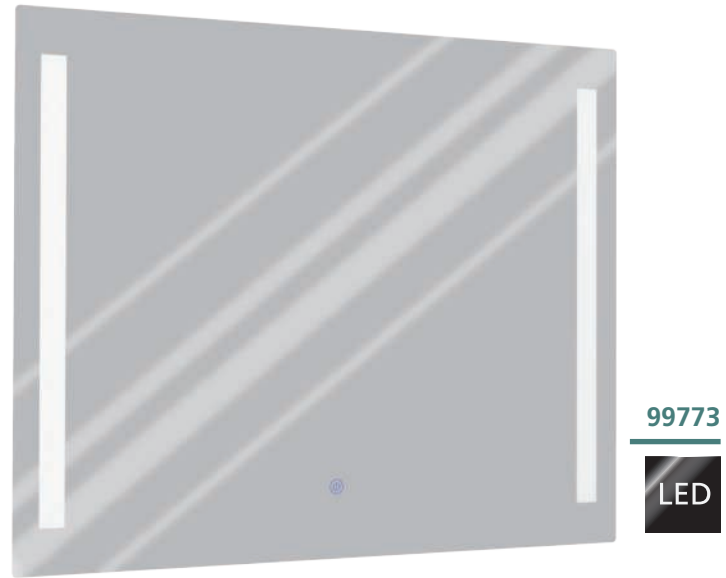

99772 BUENAVISTA

mirror light; aluminium, silver / mirror
Spiegelleuchte; Alu, silber / Spiegel
applique pour miroir; aluminium, argent / miroir

L 500, H 700, A 30



2x 6,1 W 1300 lm



IP44



9 002759 997724

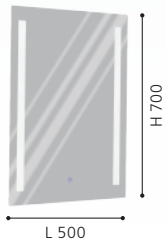

99773 BUENAVISTA

mirror light; aluminium, silver / mirror
Spiegelleuchte; Alu, silber / Spiegel
applique pour miroir; aluminium, argent / miroir

L 800, H 600, A 30



2x 5,1 W 1100 lm



IP44



9 002759 997731

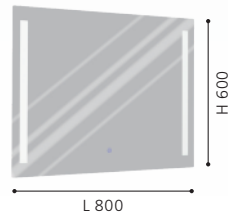

99774 BUENAVISTA

mirror light; aluminium, silver / mirror
Spiegelleuchte; Alu, silber / Spiegel
applique pour miroir; aluminium, argent / miroir

Ø 600, A 30



15,3 W 1700 lm



IP44



9 002759 997748





99774

LED



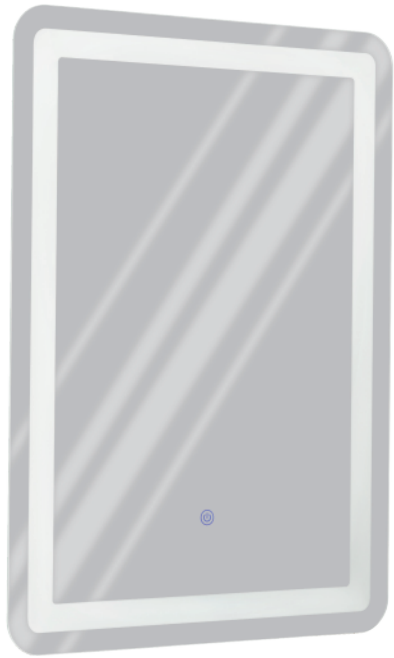

99838

LED

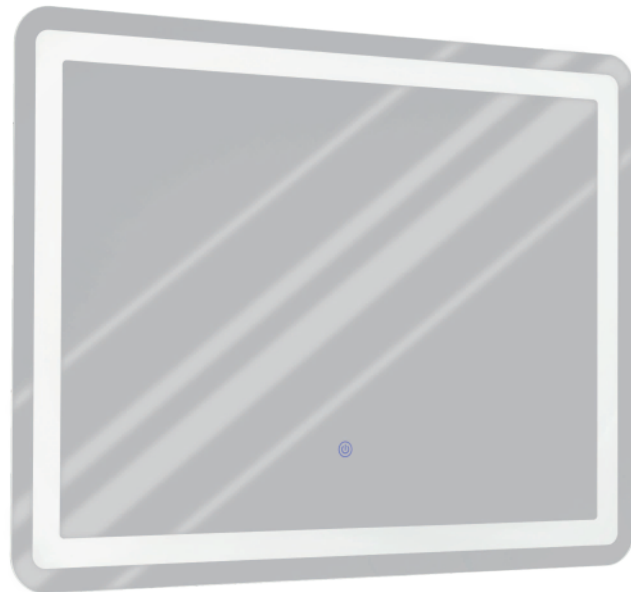

99839

LED

99838 BUENAVISTA 1

mirror light; aluminium, silver / mirror
Spiegelleuchte; Alu, silber / Spiegel
applique pour miroir; aluminium, argent / miroir

L 500, H 700, A 30



15,7W



1700lm



IP44



9 002759 998387

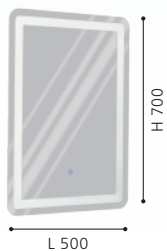

99839 BUENAVISTA 1

mirror light; aluminium, silver / mirror
Spiegelleuchte; Alu, silber / Spiegel
applique pour miroir; aluminium, argent / miroir

L 800, H 600, A 30



18,6W



2030lm



IP44



9 002759 998394

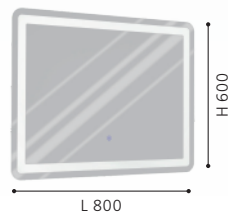

99853 BUENAVISTA 2

mirror light; aluminium, silver / mirror
Spiegelleuchte; Alu, silber / Spiegel
applique pour miroir; aluminium, argent / miroir

L 500, H 700, A 30



4x 7,1W



3000lm



IP44



9 002759 998530





99853



99854



99854 BUENAVISTA 2

mirror light; aluminium, silver / mirror
Spiegelleuchte; Alu, silber / Spiegel
applique pour miroir; aluminium, argent / miroir

L 800, H 600, A 30



4x 6,2 W



2600 lm



IP44



9 002759 998547

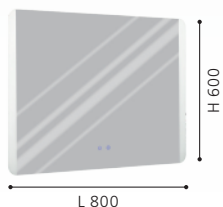

BUENAVISTA 2

The additional anti-fog function prevents the mirror from fogging up and ensures a clear view after showering.

Die zusätzliche Anti-Fog-Funktion verhindert das Beschlagen des Spiegels und sorgt für eine klare Sicht nach dem Duschen.

La fonction antibuée supplémentaire empêche le miroir de s'embuer et assure une vue dégagée après la douche.

SPOT & TRACK LUMINAIRES

SPOT- & SCHIENENLEUCHTEN
SPOTS & LUMINAIRES SUR RAIL

SYSTEMATIC LIGHTING

Our spot & track luminaires set specific highlights while optimally lighting your living rooms. No matter whether you prefer a modern or a traditional look – our range will fit any taste.

BELEUCHTUNG MIT SYSTEM

Mit unseren Spot- & Schienenleuchten setzen Sie gezielt Lichtakzente und sorgen zugleich für eine optimale Ausleuchtung Ihrer Wohnräume. Egal ob modern oder traditionell - unser Sortiment trifft jeden Geschmack.













































UN ÉCLAIRAGE AVEC SYSTÈME

Nos spots et nos luminaires sur rail vous permettent d'offrir des accents ponctuels de lumière et assurent parallèlement un éclairage optimal de vos pièces d'habitat. Qu'ils soient modernes ou traditionnels - notre gamme répond à tous les goûts.



OVERVIEW

SPOT & TRACK LUMINAIRES

							
TOWNSHEND 3 p. 660-663	BATALLAS p. 664-665	COTORRO p. 667	ESTEPERRA p. 669	VALBIANO p. 670	VILLABATE p. 671	POLLICA p. 672	BERREGAS p. 674
							
CONSACA p. 676	CASIBARE p. 678	COSWARTH p. 680	CAROVIGNO p. 682	SAMBATELLO p. 684-687	TABILLANO p. 688	ZAPATA 1 p. 690	ZAPATA p. 693
							
SERAS 1 p. 694-695	SERAS p. 696-697, 700-701	SERAS 2 p. 698-699	DAKAR 1 p. 702-703	ENEA p. 704-705	BARNHAM p. 706-707	NOCITO p. 708-709	BIMEDA p. 710-713
							
LOCANDA p. 714	CAYUCA p. 717	SOREGO p. 718	VERGIANO p. 719	DAVIDA p. 720-721	DAVIDA 1 p. 722-723	SARRIA p. 724-727	CORBERA p. 728
							
TUKON 3 p. 730	ZERACO p. 731	ROTTELO p. 732-733	BUZZ-LED p. 734-739	MAGNUM-LED p. 740-741	MAGNUM LED p. 741	CABO 1 p. 742	VILANOVA p. 742-743
							
CARDILLIO 1 p. 744-745, 747	CARDILLIO 2 p. 746-747	SALTO p. 748-749					



This product is available in different colors and shapes./ Dieser Artikel ist in unterschiedlichen Farben und Formen verfügbar.
Cet article est disponible en différentes couleurs et formes.





33169 TOWNSHEND 3

spot; wood, steel, brown, white
 Spot; Holz, Stahl, braun, weiss
 spot; bois, acier, marron, blanc

L 300, B 50



E27

2x 60W

33171 TOWNSHEND 3

spot; wood, steel, brown, white
 Spot; Holz, Stahl, braun, weiss
 spot; bois, acier, marron, blanc

L 480, B 50



E27

3x 60W

33172 TOWNSHEND 3

spot; wood, steel, brown, white
 Spot; Holz, Stahl, braun, weiss
 spot; bois, acier, marron, blanc

L 630, B 50



E27

4x 60W



9 002759 331696

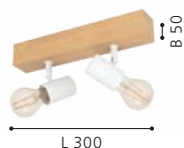

L 300



9 002759 331719

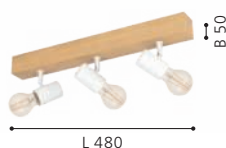

L 480



9 002759 331726

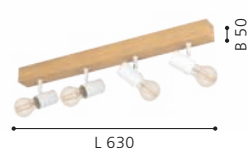

L 630



33172



33168

33168 TOWNSHEND 3

spot; wood, steel, brown, white
 Spot; Holz, Stahl, braun, weiss
 spot; bois, acier, marron, blanc

L 165, B 50





98112 TOWNSHEND 3

spot; wood, steel, brown, black
 Spot; Holz, Stahl, braun, schwarz
 spot; bois, acier, marron, noir

L 300, B 50



98113 TOWNSHEND 3

spot; wood, steel, brown, black
 Spot; Holz, Stahl, braun, schwarz
 spot; bois, acier, marron, noir

L 480, B 50



98114 TOWNSHEND 3

spot; wood, steel, brown, black
 Spot; Holz, Stahl, braun, schwarz
 spot; bois, acier, marron, noir

L 630, B 50

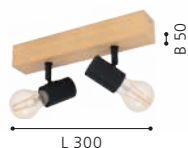



98114



98111

98111 TOWNSHEND 3

spot; wood, steel, brown, black
 Spot; Holz, Stahl, braun, schwarz
 spot; bois, acier, marron, noir

L 165, B 50





99488



99489



99491



99488 BATALLAS

spot; wood, steel, brown, black / fabric, black, white
 Spot; Holz, Stahl, braun, schwarz / Textil, schwarz, weiss
 spot; bois, acier, marron, noir / tissu, noir, blanc

L 100, H 170, A 205



E27

1x 10W

99489 BATALLAS

spot; wood, steel, brown, black / fabric, black, white
 Spot; Holz, Stahl, braun, schwarz / Textil, schwarz, weiss
 spot; bois, acier, marron, noir / tissu, noir, blanc

L 300, B 50



E27

2x 10W

99491 BATALLAS

spot; wood, steel, brown, black / fabric, black, white
 Spot; Holz, Stahl, braun, schwarz / Textil, schwarz, weiss
 spot; bois, acier, marron, noir / tissu, noir, blanc

L 480, B 50



E27

3x 10W



9 002759 994884



9 002759 994891

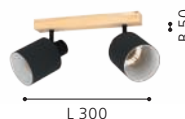

9 002759 994914

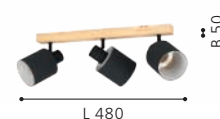



99492



99492 BATALLAS

spot; wood, steel, brown, black / fabric, black, white
 Spot; Holz, Stahl, braun, schwarz / Textil, schwarz, weiss
 spot; bois, acier, marron, noir / tissu, noir, blanc

L 630, B 50



E27



4x 10W

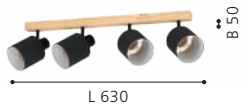



900433





900432



COTORRO



900434



900433 COTORRO

spot; wood, steel, brown, black
Spot; Holz, Stahl, braun, schwarz
spot; bois, acier, marron, noir

L 840, B 145, H 230



E27 3x 25W

900432 COTORRO

spot; wood, steel, brown, black
Spot; Holz, Stahl, braun, schwarz
spot; bois, acier, marron, noir

L 540, B 145, H 230



E27 2x 25W

900434 COTORRO

spot; wood, steel, brown, black
Spot; Holz, Stahl, braun, schwarz
spot; bois, acier, marron, noir

L 145, H 220, A 230



E27 1x 25W



9 008606 243891



9 008606 243884



9 008606 243907





99278

DESIGN
HIGHLIGHT
DETAIL



99277



99276

99278 ESTEPERRA

spot; steel, black / fabric, black, gold
Spot; Stahl, schwarz / Textil, schwarz, gold
spot; acier, noir / tissu, noir, or

L 575, B 90



E27 3x 28W



9 002759 992781



99277 ESTEPERRA

spot; steel, black / fabric, black, gold
Spot; Stahl, schwarz / Textil, schwarz, gold
spot; acier, noir / tissu, noir, or

L 335, B 90



E27 2x 28W



9 002759 992774



99276 ESTEPERRA

spot; steel, black / fabric, black, gold
Spot; Stahl, schwarz / Textil, schwarz, gold
spot; acier, noir / tissu, noir, or

H 240, Ø 120



E27 1x 28W



9 002759 992767

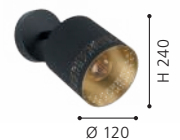



97536

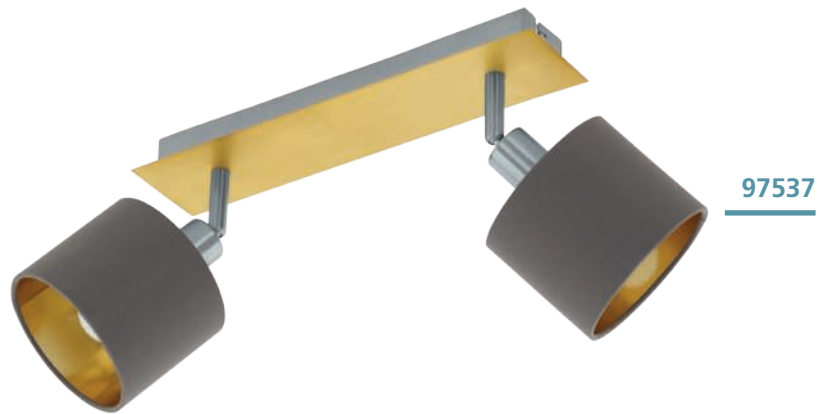

97537



97538

97536 VALBIANO

spot; steel, brushed brass, satin nickel / fabric, cappuccino, gold
Spot; Stahl, messing-gebürstet, nickel-matt / Textil, cappuccino, gold
spot; acier, laiton brossé, nickel mat / tissu, cappuccino, or

L 110, B 110



E14



1x 7W

97537 VALBIANO

spot; steel, brushed brass, satin nickel / fabric, cappuccino, gold
Spot; Stahl, messing-gebürstet, nickel-matt / Textil, cappuccino, gold
spot; acier, laiton brossé, nickel mat / tissu, cappuccino, or

L 320, B 70



E14



2x 7W

97538 VALBIANO

spot; steel, brushed brass, satin nickel / fabric, cappuccino, gold
Spot; Stahl, messing-gebürstet, nickel-matt / Textil, cappuccino, gold
spot; acier, laiton brossé, nickel mat / tissu, cappuccino, or

L 560, B 70



E14



3x 7W



9 002759 975364



L 110



9 002759 975371

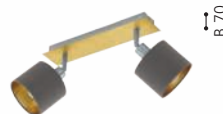

L 320



9 002759 975388



L 560



98139



98141

98139 VILLABATE

spot; steel, satin nickel / fabric, grey
Spot; Stahl, nickel-matt / Textil, grau
spot; acier, nickel mat / tissu, gris

L 335, B 90



E27 2x 10W

98141 VILLABATE

spot; steel, satin nickel / fabric, grey
Spot; Stahl, nickel-matt / Textil, grau
spot; acier, nickel mat / tissu, gris

L 575, B 90



E27 3x 10W



9 002759 981396



L 335

B 90



9 002759 981419



L 575

B 90



98624



98625

98624 POLLICA

spot; steel, black / glass vaporized, black-transparent
Spot; Stahl, schwarz / Glas bedampft, schwarz-transparent
spot; acier, noir / verre vaporisé, noir transparent

L 65, H 105



E14



1x 10W

98625 POLLICA

spot; steel, black / glass vaporized, black-transparent
Spot; Stahl, schwarz / Glas bedampft, schwarz-transparent
spot; acier, noir / verre vaporisé, noir transparent

L 365, B 165



E14



2x 28W

98626 POLLICA

spot; steel, black / glass vaporized, black-transparent
Spot; Stahl, schwarz / Glas bedampft, schwarz-transparent
spot; acier, noir / verre vaporisé, noir transparent

L 640, B 220



E14



4x 28W



9 002759 986247



L 65

H 105



9 002759 986254



L 365

B 165



9 002759 986261



L 640

B 220



98626





99052



BERREGAS



99053

99052 BERREGAS

spot; steel, black, chrome / glass vaporized, black-transparent
 Spot; Stahl, schwarz, chrom / Glas bedampft, schwarz-transparent
 spot; acier, noir, chrome / verre vaporisé, noir transparent

Ø 110



E27



1x 28W

99053 BERREGAS

spot; steel, black, chrome / glass vaporized, black-transparent
 Spot; Stahl, schwarz, chrom / Glas bedampft, schwarz-transparent
 spot; acier, noir, chrome / verre vaporisé, noir transparent

L 440, B 110



E27



2x 40W

99054 BERREGAS

spot; steel, black, chrome / glass vaporized, black-transparent
 Spot; Stahl, schwarz, chrom / Glas bedampft, schwarz-transparent
 spot; acier, noir, chrome / verre vaporisé, noir transparent

L 775, B 110



E27



3x 40W



9 002759 990527



9 002759 990534



9 002759 990541





99054





99711



CONSACA



99713

99711 CONSACA

spot; steel, black / glass vaporized, black-transparent
Spot; Stahl, schwarz / Glas bedampft, schwarz-transparent
spot; acier, noir / verre vaporisé, noir transparent

L 120, H 220, A 235



E27



1x 28W

99713 CONSACA

spot; steel, black / glass vaporized, black-transparent
Spot; Stahl, schwarz / Glas bedampft, schwarz-transparent
spot; acier, noir / verre vaporisé, noir transparent

L 780, H 205, A 235



E27



4x 40W

99712 CONSACA

spot; steel, black / glass vaporized, black-transparent
Spot; Stahl, schwarz / Glas bedampft, schwarz-transparent
spot; acier, noir / verre vaporisé, noir transparent

L 340, H 205, A 235



E27



2x 40W



9 002759 997113

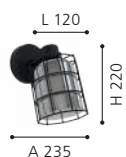

9 002759 997137



9 002759 997120





99712



99517



99518

99517 CASIBARE

spot; steel, black
Spot; Stahl, schwarz
spot; acier, noir

L 120, H 185, A 190



E27



1x 28W

99518 CASIBARE

spot; steel, black
Spot; Stahl, schwarz
spot; acier, noir

L 335, H 175, A 180



E27



2x 28W

99519 CASIBARE

spot; steel, black
Spot; Stahl, schwarz
spot; acier, noir

L 575, H 175, A 180



E27



3x 28W



9 002759 995171



9 002759 995188



9 002759 995195





99519





99075



99076

99075 COSWARTH

spot; steel, wood, anthracite, cream-white, brown
 Spot; Stahl, Holz, anthrazit, creme-weiss, braun
 spot; acier, bois, gris anthracite, blanc crème, marron

L 480, B 140, H 240



E27



2x 40W

99076 COSWARTH

spot; steel, wood, anthracite, cream-white, brown
 Spot; Stahl, Holz, anthrazit, creme-weiss, braun
 spot; acier, bois, gris anthracite, blanc crème, marron

L 670, B 140, H 240



E27



3x 40W

99074 COSWARTH

spot; steel, wood, anthracite, cream-white, brown
 Spot; Stahl, Holz, anthrazit, creme-weiss, braun
 spot; acier, bois, gris anthracite, blanc crème, marron

L 140, H 200



E27



1x 25W



9 002759 990756



L 480



9 002759 990763



L 670



9 002759 990749



L 140



99074





98621 CAROVIGNO

spot; steel, black
 Spot; Stahl, schwarz
 spot; acier, noir

L 65, H 105



E14

1x 28W

98623 CAROVIGNO

spot; steel, black
 Spot; Stahl, schwarz
 spot; acier, noir

L 640, B 150



E14

4x 40W

98622 CAROVIGNO

spot; steel, black
 Spot; Stahl, schwarz
 spot; acier, noir

L 365, B 150



E14

2x 40W



9 002759 986216

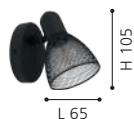

9 002759 986230



9 002759 986223





98622





98134



98135



98137

98134 SAMBATELLO

spot; wood, steel, brown, silver / steel, silver
Spot; Holz, Stahl, braun, silber / Stahl, silber
spot; bois, acier, marron, argent / acier, argent

L 150, H 220, A 240



E27



1x 40W



9 002759 981341

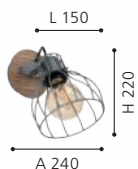

98135 SAMBATELLO

spot; wood, steel, brown, silver / steel, silver
Spot; Holz, Stahl, braun, silber / Stahl, silber
spot; bois, acier, marron, argent / acier, argent

L 335, B 90



E27



2x 40W



9 002759 981358

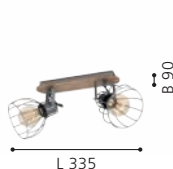

98137 SAMBATELLO

spot; wood, steel, brown, silver / steel, silver
Spot; Holz, Stahl, braun, silber / Stahl, silber
spot; bois, acier, marron, argent / acier, argent

L 795, B 90



E27



4x 40W



9 002759 981372

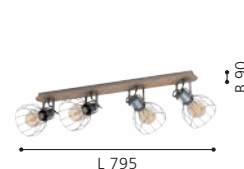



98136

98136 SAMBATELLO

spot; wood, steel, brown, silver / steel, silver
Spot; Holz, Stahl, braun, silber / Stahl, silber
spot; bois, acier, marron, argent / acier, argent

L 575, B 90



E27



3x 40W



9 002759 981365





900382



900383



900384

900382 SAMBATELLO

spot; steel, wood, black, brushed brass
 Spot; Stahl, Holz, schwarz, messing-gebürstet
 spot; acier, bois, noir, laiton brossé

L 260, B 150, H 220



E27 1x 40W

900383 SAMBATELLO

spot; steel, wood, black, brushed brass
 Spot; Stahl, Holz, schwarz, messing-gebürstet
 spot; acier, bois, noir, laiton brossé

L 480, B 280, H 260



E27 2x 40W

900384 SAMBATELLO

spot; steel, wood, black, brushed brass
 Spot; Stahl, Holz, schwarz, messing-gebürstet
 spot; acier, bois, noir, laiton brossé

L 700, B 280, H 260



E27 3x 40W



9 008606 243631



L 260



9 008606 243648

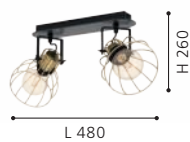

L 480



9 008606 243655



L 700



98763 TABILLANO

spot; steel, black
Spot; Stahl, schwarz
spot; acier, noir

L 440, B 110



E27

2x 40W

98764 TABILLANO

spot; steel, black
Spot; Stahl, schwarz
spot; acier, noir

L 775, B 110



E27

3x 40W

98762 TABILLANO

spot; steel, black
Spot; Stahl, schwarz
spot; acier, noir

Ø 110



E27

1x 40W



9 002759 987633

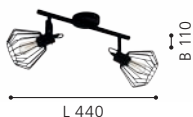

9 002759 987640



9 002759 987626





98762





32765

LED



32767

LED

32765 ZAPATA 1

spot; steel, black / glass, amber
Spot; Stahl, schwarz / Glas, amber
spot; acier, noir / verre, ambre

Ø 60



G9



1x 3W



1x
warm
WHITE
320lm



9 002759 327651



32767 ZAPATA 1

spot; steel, black / glass, amber
Spot; Stahl, schwarz / Glas, amber
spot; acier, noir / verre, ambre

L 635, B 65



G9



4x 3W



4x
warm
WHITE
320lm



9 002759 327675



L 635

32766 ZAPATA 1

spot; steel, black / glass, amber
Spot; Stahl, schwarz / Glas, amber
spot; acier, noir / verre, ambre

L 360, B 65



G9



2x 3W



2x
warm
WHITE
320lm



9 002759 327668



L 360



32766

LED



95547

LED



95546

LED



95545

LED

DESIGN
HIGHLIGHT
DETAIL

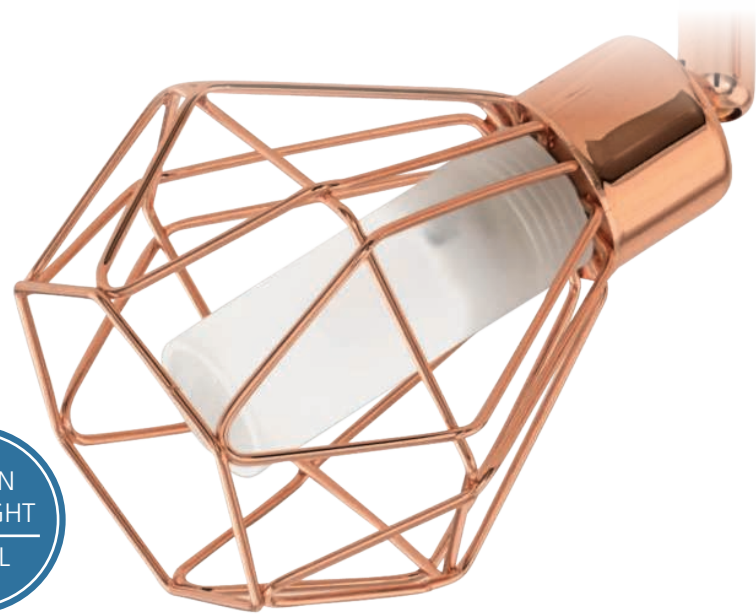

95547 ZAPATA

spot; steel, copper / satin glass, white
Spot; Stahl, kupfer / Glas satiniert, weiss
spot; acier, cuivre / verre satiné, blanc

L 515, B 65

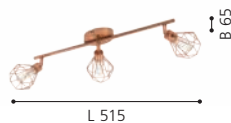
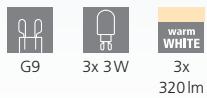

95546 ZAPATA

spot; steel, copper / satin glass, white
Spot; Stahl, kupfer / Glas satiniert, weiss
spot; acier, cuivre / verre satiné, blanc

L 360, B 65

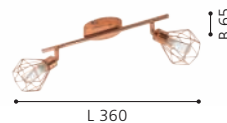
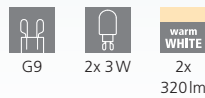

95545 ZAPATA

spot; steel, copper / satin glass, white
Spot; Stahl, kupfer / Glas satiniert, weiss
spot; acier, cuivre / verre satiné, blanc

Ø 60





98393

LED



98394

LED



98396

LED

98393 SERAS 1

spot; steel, white
Spot; Stahl, weiss
spot; acier, blanc

Ø 100



GU10



1x 3W



1x
warm
WHITE
250lm

98394 SERAS 1

spot; steel, white
Spot; Stahl, weiss
spot; acier, blanc

L 370, B 65



GU10



2x 3W



2x
warm
WHITE
250lm

98396 SERAS 1

spot; steel, white
Spot; Stahl, weiss
spot; acier, blanc

L 770, B 65



GU10



4x 3W



4x
warm
WHITE
250lm



9 002759 983932



Ø 100



9 002759 983949



L 370



9 002759 983963



L 770



98395

LED

98395 SERAS 1

spot; steel, white
Spot; Stahl, weiss
spot; acier, blanc

L 595, B 65



GU10



3x 3W



warm
WHITE
3x
250lm





96552

LED



DESIGN
HIGHLIGHT
DETAIL



96552 SERAS

spot; steel, nickel-antique, creme
Spot; Stahl, nickel-antik, creme
spot; acier, nickel antique, crème

Ø 100



GU10



1x 3W



warm
WHITE
1x
250lm



9 002759 965525



INCL.

Ø 100





96553

LED



96554

LED



96555

LED

96553 SERAS

spot; steel, nickel-antique, creme
Spot; Stahl, nickel-antik, creme
spot; acier, nickel antique, crème

L 370, B 65

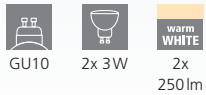

96554 SERAS

spot; steel, nickel-antique, creme
Spot; Stahl, nickel-antik, creme
spot; acier, nickel antique, crème

L 595, B 65

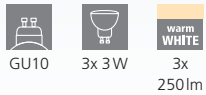

96555 SERAS

spot; steel, nickel-antique, creme
Spot; Stahl, nickel-antik, creme
spot; acier, nickel antique, crème

L 770, B 65

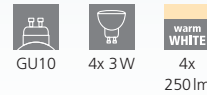



98398

LED



98397

LED

98398 SERAS 2

spot; steel, black
 Spot; Stahl, schwarz
 spot; acier, noir

L 370, B 65



GU10



2x 3W



warm
 WHITE

2x

250lm



9 002759 983987



INCL.





98399

LED



98408

LED

98397 SERAS 2

spot; steel, black
Spot; Stahl, schwarz
spot; acier, noir

Ø 100

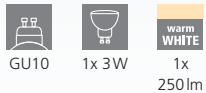

98399 SERAS 2

spot; steel, black
Spot; Stahl, schwarz
spot; acier, noir

L 595, B 65

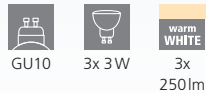

98408 SERAS 2

spot; steel, black
Spot; Stahl, schwarz
spot; acier, noir

L 770, B 65





900169

LED



900171

LED



900173

LED

900169 SERAS

spot; steel, brushed brass, gold
Spot; Stahl, messing-gebürstet, gold
spot; acier, laiton brossé, or

Ø 100



GU10



1x 3W



1x
warm
WHITE
250lm

900171 SERAS

spot; steel, brushed brass, gold
Spot; Stahl, messing-gebürstet, gold
spot; acier, laiton brossé, or

L 370, B 65



GU10



2x 3W



2x
warm
WHITE
250lm

900173 SERAS

spot; steel, brushed brass, gold
Spot; Stahl, messing-gebürstet, gold
spot; acier, laiton brossé, or

L 770, B 65



GU10



4x 3W



4x
warm
WHITE
250lm



9 008606 235643



Ø 100



9 008606 235650



L 370



9 008606 235674



L 770



900172 SERAS

spot; steel, brushed brass, gold
Spot; Stahl, messing-gebürstet, gold
spot; acier, laiton brossé, or

L 595, B 65



GU10



3x 3W



warm
WHITE
3x
250lm



9 008606 235667

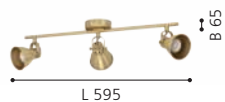



88472

DESIGN
HIGHLIGHT
DETAIL



88473



88472 DAKAR 1

spot; steel, satin nickel / glass wiping technique, white
Spot; Stahl, nickel-matt / Glas Wischtechnik, weiss
spot; acier, nickel mat / technique de verre essuyé, blanc

L 105, B 65



E14



1x 25W

88473 DAKAR 1

spot; steel, satin nickel / glass wiping technique, white
Spot; Stahl, nickel-matt / Glas Wischtechnik, weiss
spot; acier, nickel mat / technique de verre essuyé, blanc

L 370, B 100



E14



2x 40W



9 002759 884727



L 105



9 002759 884734



L 370

B 100



88474



88475

88474 DAKAR 1

spot; steel, satin nickel / glass wiping technique, white
 Spot; Stahl, nickel-matt / Glas Wischtechnik, weiss
 spot; acier, nickel mat / technique de verre essuyé, blanc

L 650, B 100



E14 4x 40W



9 002759 884741



88475 DAKAR 1

spot; steel, satin nickel / glass wiping technique, white
 Spot; Stahl, nickel-matt / Glas Wischtechnik, weiss
 spot; acier, nickel mat / technique de verre essuyé, blanc

Ø 295



E14 3x 40W



9 002759 884758





90984



90986



90985

90984 ENEA

spot; steel, satin nickel / satin glass, white
Spot; Stahl, nickel-matt / Glas satiniert, weiss
spot; acier, nickel mat / verre satiné, blanc

L 300, B 70



E14

2x 40W

90986 ENEA

spot; steel, satin nickel / satin glass, white
Spot; Stahl, nickel-matt / Glas satiniert, weiss
spot; acier, nickel mat / verre satiné, blanc

Ø 265



E14

3x 40W

90985 ENEA

spot; steel, satin nickel / satin glass, white
Spot; Stahl, nickel-matt / Glas satiniert, weiss
spot; acier, nickel mat / verre satiné, blanc

L 500, B 70



E14

3x 40W



9 002759 909840



9 002759 909864

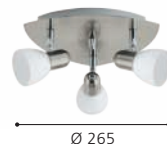

9 002759 909857

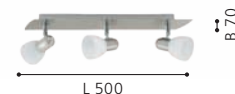



90982

90982 ENEA

spot; steel, satin nickel / satin glass, white
Spot; Stahl, nickel-matt / Glas satiniert, weiss
spot; acier, nickel mat / verre satiné, blanc

L 190, B 70



E14



1x 25W



9 002759 909826





94585 BARNHAM

spot; steel, black, copper
Spot; Stahl, schwarz, kupfer
spot; acier, noir, cuivre

L 395, B 70

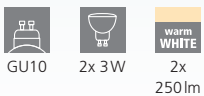

94586 BARNHAM

spot; steel, black, copper
Spot; Stahl, schwarz, kupfer
spot; acier, noir, cuivre

L 585, B 70

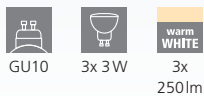

94587 BARNHAM

spot; steel, black, copper
Spot; Stahl, schwarz, kupfer
spot; acier, noir, cuivre

L 780, B 70

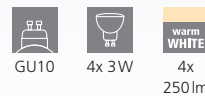



94587

LED



94584

LED

94584 BARNHAM

spot; steel, black, copper
 Spot; Stahl, schwarz, kupfer
 spot; acier, noir, cuivre

L 165, B 70



GU10



1x 3W



warm
 WHITE
 1x
 250lm



9 002759 945848



INCL.



B 70

L 165



95482

LED



95483

LED



95485

LED

95482 NOCITO

spot; steel, black, gold
Spot; Stahl, schwarz, gold
spot; acier, noir, or

Ø 110

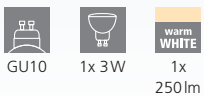

95483 NOCITO

spot; steel, black, gold
Spot; Stahl, schwarz, gold
spot; acier, noir, or

L 360, B 105

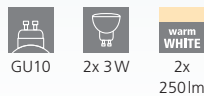

95485 NOCITO

spot; steel, black, gold
Spot; Stahl, schwarz, gold
spot; acier, noir, or

L 760, B 105

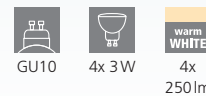

9 002759 954826



9 002759 954833



9 002759 954857





95484

LED

95484 NOCITO

spot; steel, black, gold
Spot; Stahl, schwarz, gold
spot; acier, noir, or

L 585, B 105



GU10



3x 3W



warm
WHITE

3x
250lm



9 002759 954840



DESIGN
HIGHLIGHT
DETAIL



31001

LED



31003

LED



31004

LED

31001 BIMEDA

spot; steel, white, chrome
Spot; Stahl, weiss, chrom
spot; acier, blanc, chrome

Ø 70



GU10



1x 2,8W



1x
250lm

31003 BIMEDA

spot; steel, white, chrome
Spot; Stahl, weiss, chrom
spot; acier, blanc, chrome

L 290, H 345



GU10



3x 2,8W



3x
250lm

31004 BIMEDA

spot; steel, white, chrome
Spot; Stahl, weiss, chrom
spot; acier, blanc, chrome

L 640, B 100



GU10



4x 2,8W



4x
250lm



9 002759 310011



Ø 70



9 002759 310035



L 290

H 345



9 002759 310042



L 640

B 100



31002

LED

31002 BIMEDA

spot; steel, white, chrome
Spot; Stahl, weiss, chrom
spot; acier, blanc, chrome

L 365, B 100



GU10



2x 2,8W



warm
WHITE
2x
250lm



9 002759 310028





31005

LED



DESIGN
HIGHLIGHT
DETAIL

31005 BIMEDA

spot; steel, nickel-nero, chrome
Spot; Stahl, nickel-nero, chrom
spot; acier, nickel brillant, chrome

Ø 70



GU10



1x 2,8W



1x

250lm



9 002759 310059



INCL.





31006 BIMEDA

spot; steel, nickel-nero, chrome
Spot; Stahl, nickel-nero, chrom
spot; acier, nickel brillant, chrome

L 365, B 100

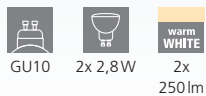

31007 BIMEDA

spot; steel, nickel-nero, chrome
Spot; Stahl, nickel-nero, chrom
spot; acier, nickel brillant, chrome

L 290, H 345

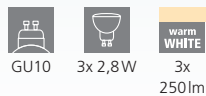

31008 BIMEDA

spot; steel, nickel-nero, chrome
Spot; Stahl, nickel-nero, chrom
spot; acier, nickel brillant, chrome

L 640, B 100

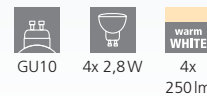

DESIGN
HIGHLIGHT
DETAIL



94251

LED

94251 LOCANDA

ceiling light; steel, satin nickel, chrome
Deckenleuchte; Stahl, nickel-matt, chrom
plafonnier; acier, nickel mat, chrome

L 700, B 660

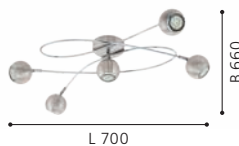
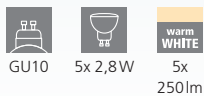

94252 LOCANDA

ceiling light; steel, white, chrome
Deckenleuchte; Stahl, weiss, chrom
plafonnier; acier, blanc, chrome

L 700, B 660

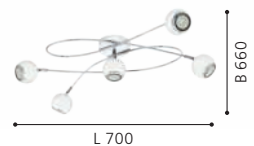
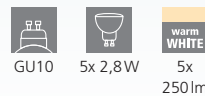



94252

LED





900438

LED



900436

LED

DESIGN
HIGHLIGHT
DETAIL



900437

LED

900438 CAYUCA

spot; steel, black / wood, brown
Spot; Stahl, schwarz / Holz, braun
spot; acier, noir / bois, marron

L 580, B 100, H 120



GU10



4x 3W



4x
warm
WHITE
250lm

900436 CAYUCA

spot; steel, black / wood, brown
Spot; Stahl, schwarz / Holz, braun
spot; acier, noir / bois, marron

L 110, B 105, H 120



GU10



1x 3W



1x
warm
WHITE
250lm

900437 CAYUCA

spot; steel, black / wood, brown
Spot; Stahl, schwarz / Holz, braun
spot; acier, noir / bois, marron

L 280, B 100, H 120



GU10



2x 3W



2x
warm
WHITE
250lm



9 008606 240005



L 580



9 008606 239986



L 110



9 008606 239993



L 280



900331



900332



900333



900331 SOREGO

spot; steel, black
Spot; Stahl, schwarz
spot; acier, noir

L 110, B 105, H 120



GU10



1x 3W



1x
250lm

900332 SOREGO

spot; steel, black
Spot; Stahl, schwarz
spot; acier, noir

L 280, B 100, H 120



GU10



2x 3W



2x
250lm

900333 SOREGO

spot; steel, black
Spot; Stahl, schwarz
spot; acier, noir

L 580, B 100, H 120



GU10



4x 3W



4x
250lm



L 110



L 280



L 580



97506

LED



97507

LED



97508

LED

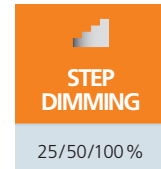

97506

97508

97507

25/50/100%

97506 VERGIANO

spot; aluminium, steel, white, satin nickel
Spot; Alu, Stahl, weiss, nickel-matt
spot; aluminium, acier, blanc, nickel mat

L 70, H 165



GU10



1x 5W



1x
warm
WHITE
400lm



9 002759 975067



97507 VERGIANO

spot; aluminium, steel, white, satin nickel
Spot; Alu, Stahl, weiss, nickel-matt
spot; aluminium, acier, blanc, nickel mat

L 390, B 70



GU10



2x 5W



2x
warm
WHITE
400lm



9 002759 975074

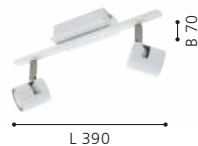

L 390

97508 VERGIANO

spot; aluminium, steel, white, satin nickel
Spot; Alu, Stahl, weiss, nickel-matt
spot; aluminium, acier, blanc, nickel mat

L 690, B 70



GU10



3x 5W



3x
warm
WHITE
400lm



9 002759 975081

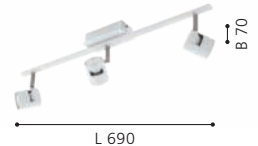

L 690



92084

LED



92085

LED



92086

LED

92084 DAVIDA

spot; steel, chrome, white
Spot; Stahl, chrom, weiss
spot; acier, chrome, blanc

L 165, B 70



GU10



1x 4,6W



warm
WHITE

1x
400lm



92085 DAVIDA

spot; steel, chrome, white
Spot; Stahl, chrom, weiss
spot; acier, chrome, blanc

L 390, B 70



GU10



2x 4,6W



warm
WHITE

2x
400lm

92086 DAVIDA

spot; steel, chrome, white
Spot; Stahl, chrom, weiss
spot; acier, chrome, blanc

L 580, B 70



GU10



3x 4,6W



warm
WHITE

3x
400lm



9 002759 920845



B 70



9 002759 920852



L 390



9 002759 920869



L 580



92087

LED

92087 DAVIDA

spot; steel, chrome, white
Spot; Stahl, chrom, weiss
spot; acier, chrome, blanc

L 780, B 70



GU10



4x 4,6W



4x
warm
WHITE
400lm



9 002759 920876

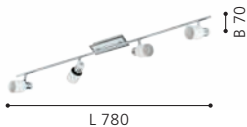



30833

LED



30832

LED

30832 DAVIDA 1

spot; steel, nickel-nero
 Spot; Stahl, nickel-nero
 spot; acier, nickel noir

L 165, B 70



GU10



1x 4,6W



warm
 WHITE

1x

400lm



9 002759 308322



INCL.



B 70

L 165



30834

LED

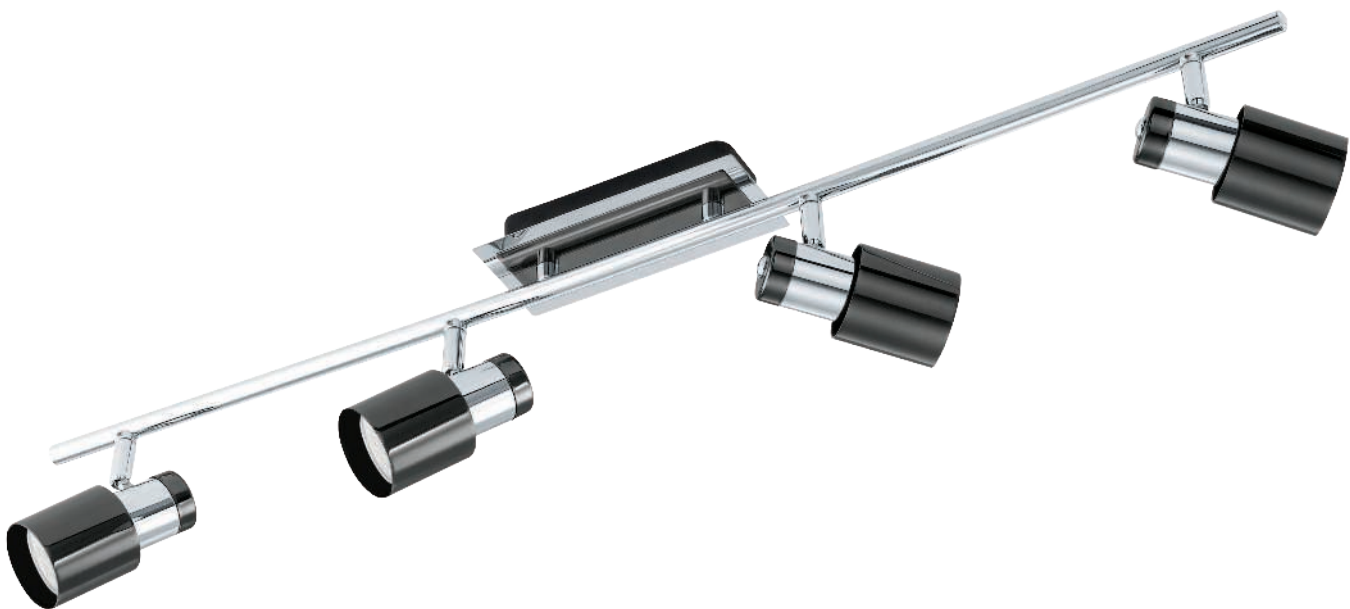

30835

LED

30833 DAVIDA 1

spot; steel, nickel-nero
Spot; Stahl, nickel-nero
spot; acier, nickel noir

L 390, B 70

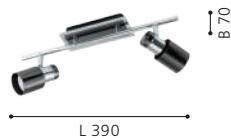
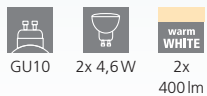

30834 DAVIDA 1

spot; steel, nickel-nero
Spot; Stahl, nickel-nero
spot; acier, nickel noir

L 580, B 70

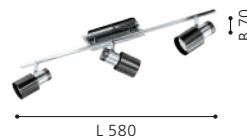
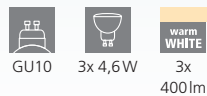

30835 DAVIDA 1

spot; steel, nickel-nero
Spot; Stahl, nickel-nero
spot; acier, nickel noir

L 780, B 70

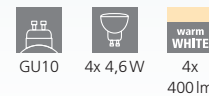



94962

LED



94958

LED

94962 SARRIA

spot; steel, white, chrome
Spot; Stahl, weiss, chrom
spot; acier, blanc, chrome

L 240, H 260



GU10



4x 4,5W



warm
WHITE

4x

345lm



9 002759 949624



L 240

H 260



94959

LED



94961

LED

94958 SARRIA

spot; steel, white, chrome
Spot; Stahl, weiss, chrom
spot; acier, blanc, chrome

L 120, B 60

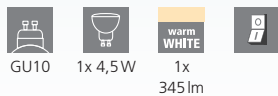

94959 SARRIA

spot; steel, white, chrome
Spot; Stahl, weiss, chrom
spot; acier, blanc, chrome

L 300, B 70

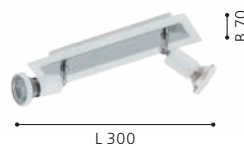
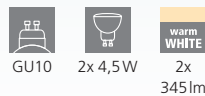

94961 SARRIA

spot; steel, white, chrome
Spot; Stahl, weiss, chrom
spot; acier, blanc, chrome

L 460, B 70

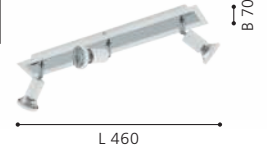
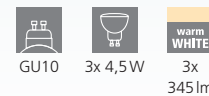



94963

LED



94966

LED



94964

LED

94963 SARRIA

spot; steel, black, chrome
Spot; Stahl, schwarz, chrom
spot; acier, noir, chrome

L 120, B 60

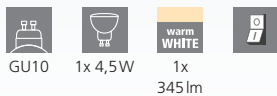

GU10 1x 4,5W 1x 345lm

94964 SARRIA

spot; steel, black, chrome
Spot; Stahl, schwarz, chrom
spot; acier, noir, chrome

L 300, B 70

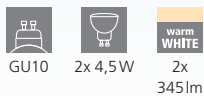

GU10 2x 4,5W 2x 345lm

94966 SARRIA

spot; steel, black, chrome
Spot; Stahl, schwarz, chrom
spot; acier, noir, chrome

L 240, H 260

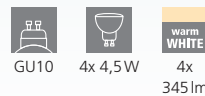

GU10 4x 4,5W 4x 345lm



9 002759 949631



9 002759 949648



9 002759 949662





94965 SARRIA

spot; steel, black, chrome
Spot; Stahl, schwarz, chrom
spot; acier, noir, chrome

L 460, B 70



GU10



3x 4,5 W



warm
WHITE
3x
345 lm



9 002759 949655



INCL.

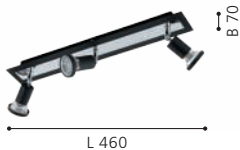

L 460



DESIGN
HIGHLIGHT
DETAIL



CORBERA

Designer spot series with special spot heads.

Spotsérie mit Spotköpfen in besonderem Design.

Série de spot avec des têtes de spot spéciales.

93672 CORBERA

spot; steel, plastic, chrome
Spot; Stahl, Kunststoff, chrom
spot; acier, plastique, chrome

L 120, B 60

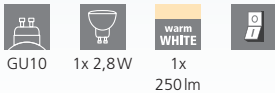

93673 CORBERA

spot; steel, plastic, chrome
Spot; Stahl, Kunststoff, chrom
spot; acier, plastique, chrome

L 390, B 70

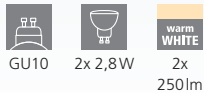

93674 CORBERA

spot; steel, plastic, chrome
Spot; Stahl, Kunststoff, chrom
spot; acier, plastique, chrome

L 585, B 70

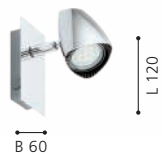
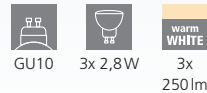



93674

LED

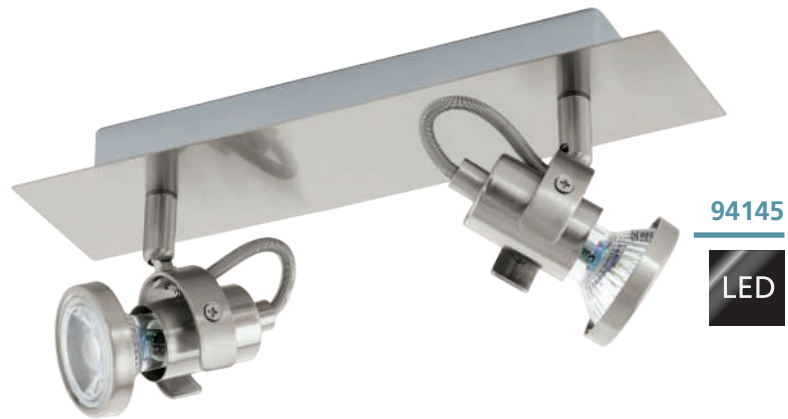

94145 TUKON 3

spot; steel, satin nickel
Spot; Stahl, nickel-matt
spot; acier, nickel mat

L 280, B 70

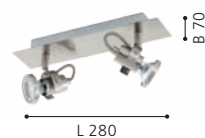
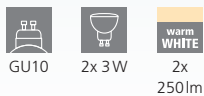

94146 TUKON 3

spot; steel, satin nickel
Spot; Stahl, nickel-matt
spot; acier, nickel mat

L 460, B 70

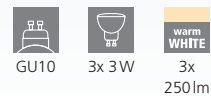

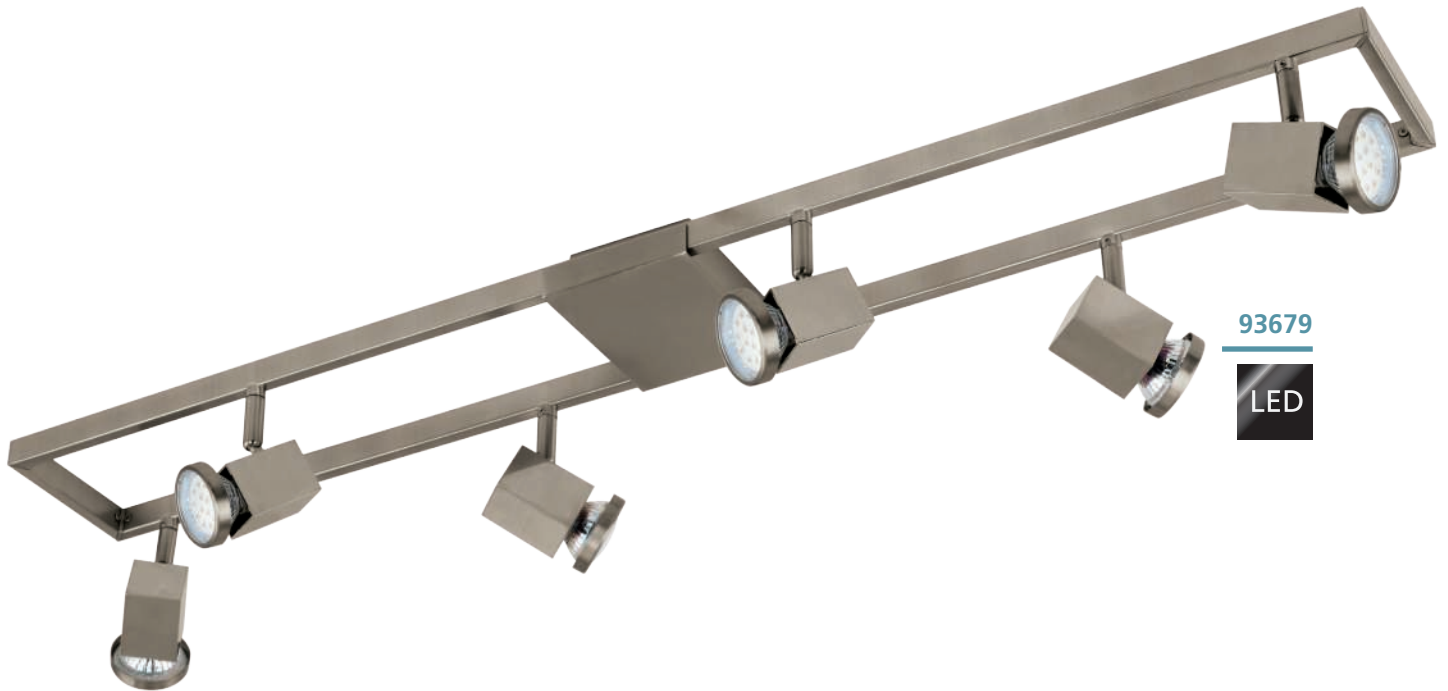

93679

LED

93679 ZERACO

spot; steel, plastic, satin nickel
 Spot; Stahl, Kunststoff, nickel-matt
 spot; acier, plastique, nickel mat

L 940, B 120



GU10



6x 4,6W



6x
 warm
 WHITE
 400lm

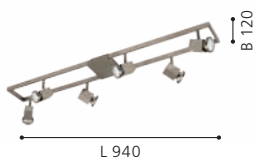



90915

LED



90914

LED



90916

LED

90915 ROTTELO

spot; steel, satin nickel, chrome
Spot; Stahl, nickel-matt, chrom
spot; acier, nickel mat, chrome

L 280, B 70



GU10



2x 4,6W



warm
WHITE

2x
400lm



9 002759 909154



L 280

B 70

90914 ROTTELO

spot; steel, satin nickel, chrome
Spot; Stahl, nickel-matt, chrom
spot; acier, nickel mat, chrome

L 120, B 60



GU10



1x 4,6W



warm
WHITE

1x
400lm



9 002759 909147



B 60

L 120



9 002759 909161



L 260

B 240



90917

LED



90927

LED

90917 ROTTELO

spot; steel, satin nickel, chrome
 Spot; Stahl, nickel-matt, chrom
 spot; acier, nickel mat, chrome

L 780, B 70

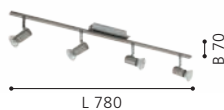
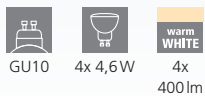

90927 ROTTELO

spot; steel, satin nickel, chrome
 Spot; Stahl, nickel-matt, chrom
 spot; acier, nickel mat, chrome

L 1160, B 70

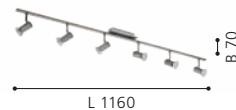
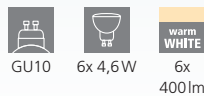



92595

LED



92596

LED



92597

LED

92595 BUZZ-LED

spot; steel, satin nickel
Spot; Stahl, nickel-matt
spot; acier, nickel mat

Ø 60



GU10



1x 2,8W



1x
250lm

92596 BUZZ-LED

spot; steel, satin nickel
Spot; Stahl, nickel-matt
spot; acier, nickel mat

L 285, B 65



GU10



2x 2,8W



2x
250lm

92597 BUZZ-LED

spot; steel, satin nickel
Spot; Stahl, nickel-matt
spot; acier, nickel mat

L 485, B 65



GU10



3x 2,8W



3x
250lm



9 002759 925956



Ø 60



9 002759 925963



L 285

B 65



9 002759 925970



L 485

B 65



92598

LED



92599

LED

92598 BUZZ-LED

spot; steel, satin nickel
Spot; Stahl, nickel-matt
spot; acier, nickel mat

L 685, B 65

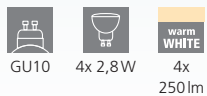

92599 BUZZ-LED

spot; steel, satin nickel
Spot; Stahl, nickel-matt
spot; acier, nickel mat

L 1050, B 65

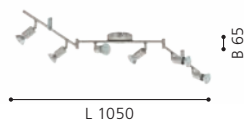
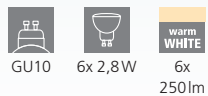



32428

LED



32429

LED



32431

LED

32428 BUZZ-LED

spot; steel, black
Spot; Stahl, schwarz
spot; acier, noir

Ø 60



GU10



1x 2,8W



1x
warm
WHITE
250lm

32429 BUZZ-LED

spot; steel, black
Spot; Stahl, schwarz
spot; acier, noir

L 285, B 65



GU10



2x 2,8W



2x
warm
WHITE
250lm

32431 BUZZ-LED

spot; steel, black
Spot; Stahl, schwarz
spot; acier, noir

L 485, B 65



GU10



3x 2,8W



3x
warm
WHITE
250lm



9 002759 324285



Ø 60



9 002759 324292



L 285

B 65



9 002759 324315



L 485

B 65



32432

LED



32433

LED

32432 BUZZ-LED

spot; steel, black
Spot; Stahl, schwarz
spot; acier, noir

L 685, B 65



GU10



4x 2,8W



4x
warm
WHITE
250lm



9 002759 324322



32433 BUZZ-LED

spot; steel, black
Spot; Stahl, schwarz
spot; acier, noir

L 1050, B 65



GU10



6x 2,8W



6x
warm
WHITE
250lm



9 002759 324339





33184

LED



33185

LED



33186

LED

33184 BUZZ-LED

spot; steel, brushed brass
Spot; Stahl, messing-gebürstet
spot; acier, laiton brossé

Ø 60



GU10



1x 2,8W



1x
warm
WHITE
250lm

33185 BUZZ-LED

spot; steel, brushed brass
Spot; Stahl, messing-gebürstet
spot; acier, laiton brossé

L 285, B 65



GU10



2x 2,8W



2x
warm
WHITE
250lm

33186 BUZZ-LED

spot; steel, brushed brass
Spot; Stahl, messing-gebürstet
spot; acier, laiton brossé

L 485, B 65



GU10



3x 2,8W



3x
warm
WHITE
250lm



9 002759 331849



Ø 60



9 002759 331856



L 285

B 65



9 002759 331863



L 485

B 65



33187

LED

33187 BUZZ-LED

spot; steel, brushed brass
Spot; Stahl, messing-gebürstet
spot; acier, laiton brossé

L 685, B 65



GU10



4x 2,8W



warm
WHITE
4x
250lm



9 002759 331870

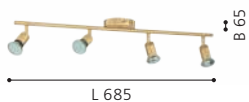



92641

LED



92642

LED



92643

LED

92641 MAGNUM-LED

spot; steel, satin nickel, chrome
Spot; Stahl, nickel-matt, chrom
spot; acier, nickel mat, chrome

Ø 70



GU10



1x 2,8W



1x
warm
WHITE
250lm



9 002759 926410



Ø 70

92642 MAGNUM-LED

spot; steel, satin nickel, chrome
Spot; Stahl, nickel-matt, chrom
spot; acier, nickel mat, chrome

L 330, B 105



GU10



2x 2,8W



2x
warm
WHITE
250lm



9 002759 926427



L 330

B 105

92643 MAGNUM-LED

spot; steel, satin nickel, chrome
Spot; Stahl, nickel-matt, chrom
spot; acier, nickel mat, chrome

L 255, H 295



GU10



3x 2,8W



3x
warm
WHITE
250lm



9 002759 926434



L 255

H 295



95824

LED



92644

LED



92645

LED

95824 MAGNUM LED

spot; steel, satin nickel, chrome
Spot; Stahl, nickel-matt, chrom
spot; acier, nickel mat, chrome

Ø 180



GU10



3x 2,8W



3x
warm
WHITE
250lm



9 002759 958244



Ø 180

92644 MAGNUM-LED

spot; steel, satin nickel, chrome
Spot; Stahl, nickel-matt, chrom
spot; acier, nickel mat, chrome

L 645, B 105



GU10



4x 2,8W



4x
warm
WHITE
250lm



9 002759 926441



L 645

B 105

92645 MAGNUM-LED

spot; steel, satin nickel, chrome
Spot; Stahl, nickel-matt, chrom
spot; acier, nickel mat, chrome

L 1050



GU10



6x 2,8W



6x
warm
WHITE
250lm



9 002759 926458



L 1050



93359

LED



93085

LED



93358

93359



94609

93085 CABO 1

wall / ceiling light; steel, chrome / satin glass, white, clear
Wand- / Deckenleuchte; Stahl, chrom / Glas satiniert, weiss, klar
applique / plafonnier; acier, chrome / verre satiné, blanc, transparent

H 100, Ø 290



GU10



4x 2,8W



4x
250lm

93359 VILANOVA

system; aluminium, steel, aluminium, chrome
System; Alu, Stahl, alu, chrom
système; aluminium, acier, aluminium, chrome

L 2000, H 200



GU10



5x 2,8W



5x
250lm

94609 VILANOVA

accessory; steel, satin nickel
Zubehör; Stahl, nickel-matt
accessoire; acier, nickel mat

L 395



9 002759 930851



9 002759 933593

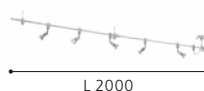

9 002759 946098

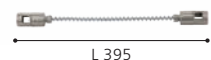



93358

LED

93358 VILANOVA

system; aluminium, steel, aluminium, chrome / glass, white, clear
 System; Alu, Stahl, alu, chrom / Glas, weiss, klar
 système; aluminium, acier, aluminium, chrome / verre, blanc, transparent

L 2000, H 200



GU10



5x 4,6W



5x
 warm
 WHITE
 400lm



9 002759 933586



INCL.



L 2000

94609

Set to connect 93359 and 93358 tracks:

- > 250mm Kabel
- > 2 end parts
- > 1 straight connector for direct connection

Verbindungsset für 93359 und 93358 Schienen:

- > 250mm Kabel
- > 2 Endstücke
- > 1 Verbinder für eine direkte Verbindung

Set de connexion pour rails 93359 et 93358:

- > câble de 250mm
- > 2 pièces d'about
- > 1 connecteur pour une connexion directe

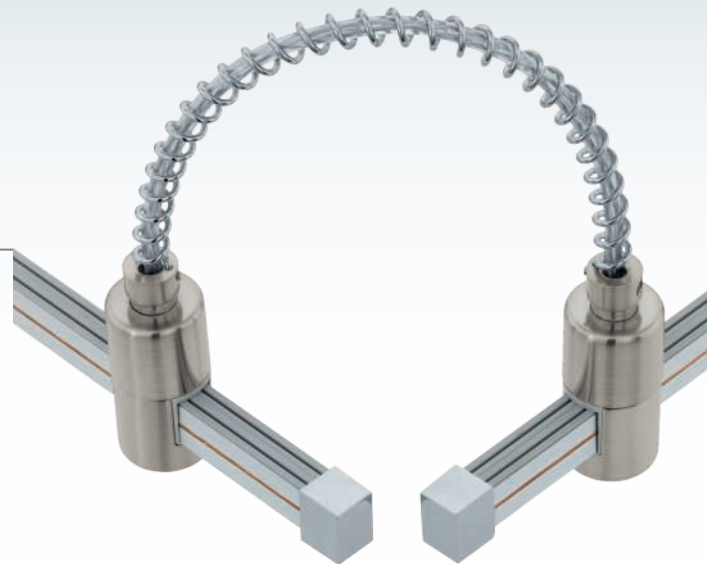



96182

LED



96178

LED



96179

LED

96182 CARDILLO 1

spot; aluminium, steel, aluminium, chrome / plastic, satiné
Spot; Alu, Stahl, alu, chrom / Kunststoff, satiniert
spot; aluminium, acier, aluminium, chrome / plastique, satiné

L 985, B 85

LED

warm
WHITE

LED

warm
WHITE



4x 3,2W 1760lm 2x 3,3W 800lm



9 002759 961824



96178 CARDILLO 1

spot; aluminium, steel, aluminium, chrome / plastic, satiné
Spot; Alu, Stahl, alu, chrom / Kunststoff, satiniert
spot; aluminium, acier, aluminium, chrome / plastique, satiné

L 225, B 65

LED

warm
WHITE

LED

warm
WHITE



1x 3,2W 440lm 1x 2,2W 260lm



9 002759 961787



96179 CARDILLO 1

spot; aluminium, steel, aluminium, chrome / plastic, satiné
Spot; Alu, Stahl, alu, chrom / Kunststoff, satiniert
spot; aluminium, acier, aluminium, chrome / plastique, satiné

L 390, B 85

LED

warm
WHITE

LED

warm
WHITE



2x 3,2W 880lm 1x 3,3W 400lm



9 002759 961794

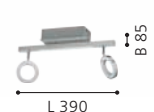



96181

LED

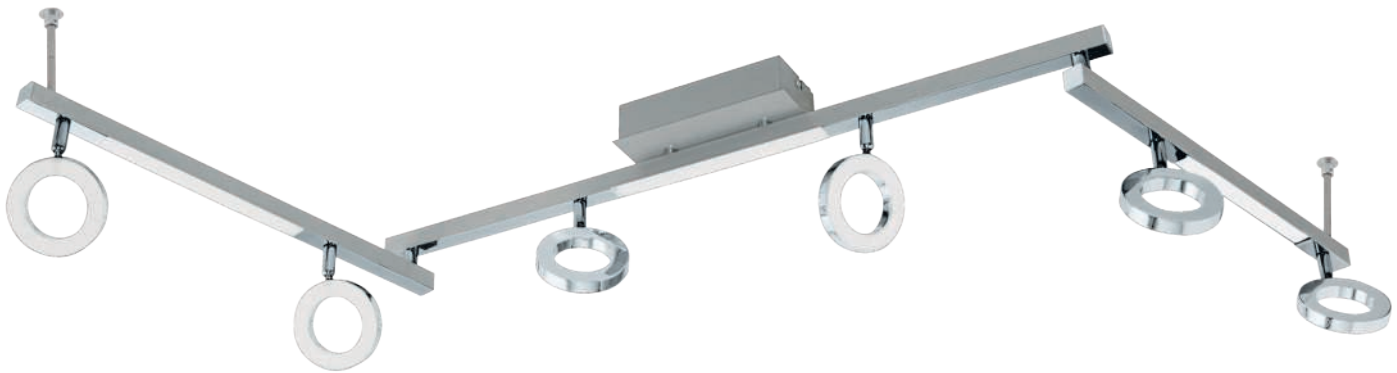

96183

LED



96181 CARDILLIO 1

spot; aluminium, steel, aluminium, chrome / plastic, satiné
Spot; Alu, Stahl, alu, chrom / Kunststoff, satiniert
spot; aluminium, acier, aluminium, chrome / plastique, satiné

L 690, B 85



9 002759 961817

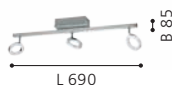

96183 CARDILLIO 1

spot; aluminium, steel, aluminium, chrome / plastic, satiné
Spot; Alu, Stahl, alu, chrom / Kunststoff, satiniert
spot; aluminium, acier, aluminium, chrome / plastique, satiné

L 1585, B 85



9 002759 961831

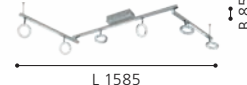

CARDILLIO 1

These luminaires have different lighting sources. Profil lights combined with spot heads create basic lighting as well as accent lighting.

Diese Leuchten verfügen über unterschiedliche Lichtquellen. Profileuchten kombiniert mit Spotköpfen schaffen sowohl Grundlicht als auch Akzentbeleuchtung.

Ces luminaires ont des sources d'éclairage différentes. La combinaison entre un éclairage sur la base du produit et un spot vous permet d'avoir un éclairage général mais aussi directionnel.



900516

LED



900513

LED

900516 CARDILLO 2

spot; aluminium, steel, black / plastic, satiné
Spot; Alu, Stahl, schwarz / Kunststoff, satiniert
spot; aluminium, acier, noir / plastique, satiné

L 985, B 85, H 175

LED warm WHITE LED warm WHITE

4x 3,2W 1600lm 2x 3,3W 720lm



9 008606 244454



L 985

900513 CARDILLO 2

spot; aluminium, steel, black / plastic, satiné
Spot; Alu, Stahl, schwarz / Kunststoff, satiniert
spot; aluminium, acier, noir / plastique, satiné

L 225, B 65, H 165

LED warm WHITE LED warm WHITE

1x 3,2W 400lm 1x 2,2W 240lm



9 008606 244423



L 225



900514 CARDILLIO 2

spot; aluminium, steel, black / plastic, satiné
Spot; Alu, Stahl, schwarz / Kunststoff, satiniert
spot; aluminium, acier, noir / plastique, satiné

L 385, B 85, H 175



900515 CARDILLIO 2

spot; aluminium, steel, black / plastic, satiné
Spot; Alu, Stahl, schwarz / Kunststoff, satiniert
spot; aluminium, acier, noir / plastique, satiné

L 385, B 85, H 175



900839 CARDILLIO 1

spot; aluminium, steel, black / plastic, satiné
Spot; Alu, Stahl, schwarz / Kunststoff, satiniert
spot; aluminium, acier, noir / plastique, satiné

L 1585, B 85, H 200

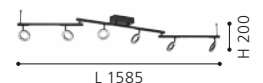



95629

LED



DESIGN
HIGHLIGHT
DETAIL

95629 SALTO

spot; steel, chrome / plastic, satined

Spot; Stahl, chrom / Kunststoff, satiniert

spot; acier, chrome / plastique, satiné

L 360, B 120

LED

2x 5,4W

warm
WHITE

2x
640lm



9 002759 956295





95628

LED



95631

LED



95632

LED

95628 SALTO

spot; steel, chrome / plastic, satiné
Spot; Stahl, chrom / Kunststoff, satiniert
spot; acier, chrome / plastique, satiné

Ø 110



1x 5,4W

1x
640lm



9 002759 956288



95631 SALTO

spot; steel, chrome / plastic, satiné
Spot; Stahl, chrom / Kunststoff, satiniert
spot; acier, chrome / plastique, satiné

L 560, B 130



3x 5,4W

3x
640lm



9 002759 956318



95632 SALTO

spot; steel, chrome / plastic, satiné
Spot; Stahl, chrom / Kunststoff, satiniert
spot; acier, chrome / plastique, satiné

L 760, B 130



4x 5,4W

4x
640lm



9 002759 956325



CLIP & PLUG LUMINAIRES

KLEMM- & STECKERLEUCHTEN
LUMINAIRES À PINCE & SUR PRISE

LIGHT - VIRTUALLY ANYWHERE

Our clamping and plug-in luminaires inspire with their flexible uses. They serve as pleasant reading lamps or can be positioned for targeted highlighting.

LICHT - PRAKTISCH ÜBERALL

Unsere Klemm- und Steckerleuchten begeistern durch ihre flexible Verwendbarkeit. Sie dienen als angenehme Lesebeleuchtung oder können zur gezielten Lichtsetzung positioniert werden.



LA LUMIÈRE - PRATIQUE ET PARTOUT

Nos luminaires à pinces et à fiches ravissent de leurs possibilités flexibles d'utilisation. Ils servent de lumière agréable pour la lecture ou peuvent être positionnés afin d'offrir une lumière ciblée.

OVERVIEW

CLIP & PLUG LUMINAIRES



CABADO
p. 752



FABIO
p. 752



RICCIO 1
p. 753



TINEO
p. 753



MINI 4
p. 754-755



DAKAR 3
p. 754



This product is available in different colors and shapes./ Dieser Artikel ist in unterschiedlichen Farben und Formen verfügbar.
Cet article est disponible en différentes couleurs et formes.



97077

LED

97077 CABADO

clamp light; plastic, white
Klemmleuchte; Kunststoff, weiss
luminaire à pince; plastique, blanc

L 120, B 65, H 420



1,6W



150lm



Li-ion



500mAh



9 002759 970772



H 420

L 120



81262

81262 FABIO

clamp light; steel, plastic, white, silver
Klemmleuchte; Stahl, Kunststoff, weiss, silber
luminaire à pince; acier, plastique, blanc, argent

H 300



E14



1x 40W



81265 FABIO

clamp light; steel, plastic, silver
Klemmleuchte; Stahl, Kunststoff, silber
luminaire à pince; acier, plastique, argent

H 300



E14



1x 40W



9 002759 812621



H 300



9 002759 812652



H 300



94329

LED

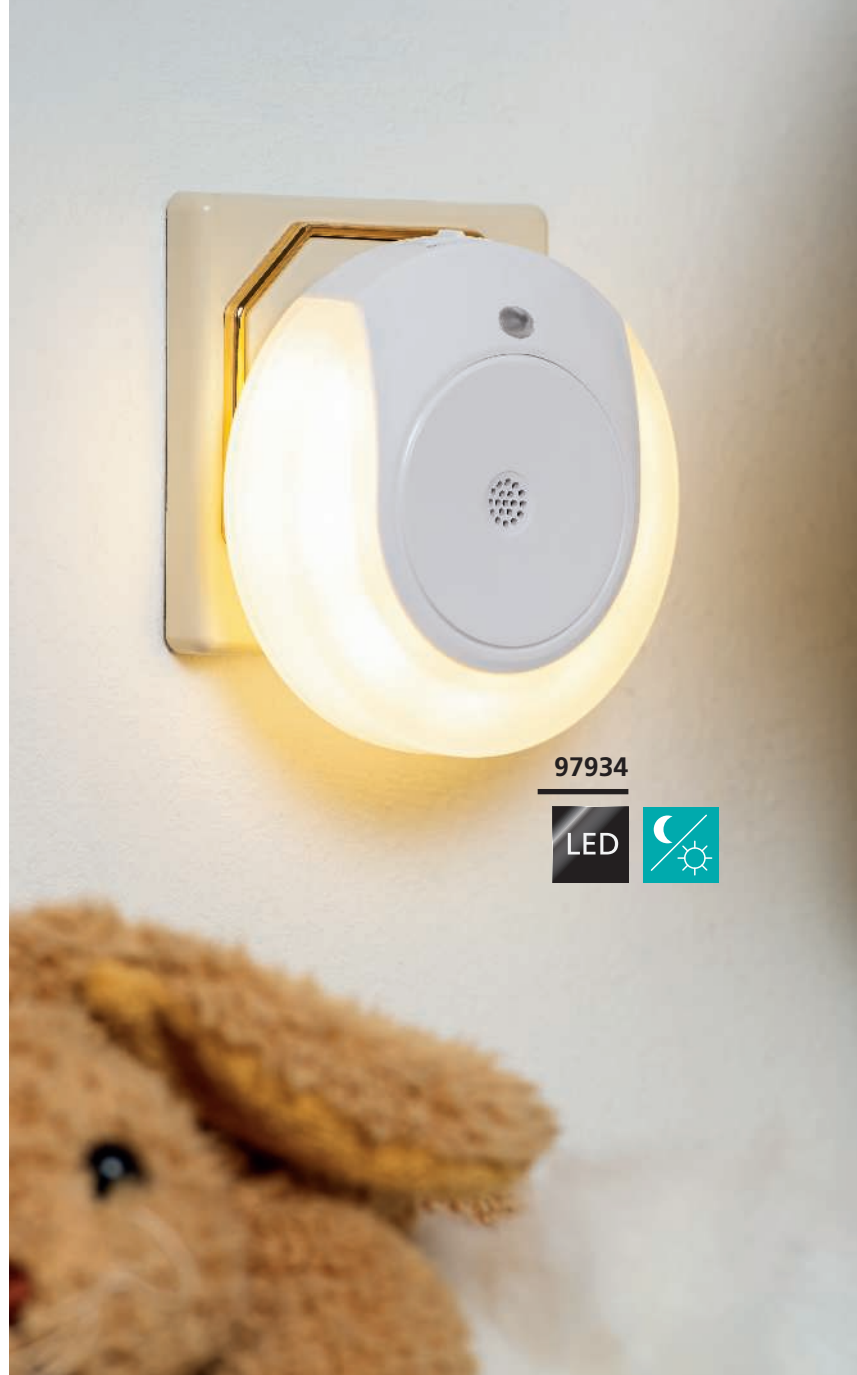

97934

LED

94329 RICCIO 1

clamp light; plastic, steel, white, chrome / steel, white, chrome
 Klemmleuchte; Kunststoff, Stahl, weiss, chrom / Stahl, weiss, chrom
 luminaire à pince; plastique, acier, blanc, chrome / acier, blanc, chrome

L 180, H 330

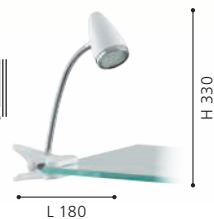

97934 TINEO

plug light; plastic, white
 Steckerleuchte; Kunststoff, weiss
 luminaire sur prise; plastique, blanc

L 90, B 70, H 90



97934

This luminaire is equipped with a voice sensor. If an acoustic signal reaches an intensity of 60 dB, the night light will switch on automatically.

Diese Leuchte ist mit einem Akustiksensoren ausgestattet. Bei einem akustischen Signal ab 60 dB schaltet sich das Nachtlicht automatisch ein.

Cette lumière est équipée d'un capteur acoustique. A un signal acoustique dès 60 dB, la lumière de nuit s'intervient automatiquement.



92924

LED



92925

LED



92935

92925 MINI 4

plug light; steel, white, chrome
Steckerleuchte; Stahl, weiss, chrom
luminaire sur prise; acier, blanc, chrome

L 70, H 100



92924 MINI 4

plug light; steel, satin nickel, chrome
Steckerleuchte; Stahl, nickel-matt, chrom
luminaire sur prise; acier, nickel mat, chrome

L 70, H 100



92935 DAKAR 3

plug light; steel, satin nickel, chrome / plastic, white
Steckerleuchte; Stahl, nickel-matt, chrom / Kunststoff, weiss
luminaire sur prise; acier, nickel mat, chrome / plastique, blanc

L 70, H 180, A 280

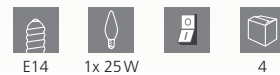



92933

LED

92933 MINI 4

plug light; steel, satin nickel, chrome
Steckerleuchte; Stahl, nickel-matt, chrom
luminaire sur prise; acier, nickel mat, chrome

L 70, H 180, A 220



GU10



1x 2,8W



1x
warm
WHITE
250lm



4



9 002759 929336



TABLE & FLOOR LUMINAIRES

TISCH- & STEHLEUCHTEN

LUMINAIRES DE TABLE & LAMPADAIRES

WE LOVE LIGHT

The range of table and floor luminaires is made up of many different styles and convinces with its diverse uses. The luminaires give your home a comfortable light mood and turn into chic living room accessories.

WIR STEHEN AUF LICHT

Das Sortiment der Tisch- und Stehleuchten setzt sich aus unterschiedlichen Stilen zusammen und überzeugt mit seinen vielseitigen Einsatzmöglichkeiten. Die Leuchten verleihen Ihrem Zuhause eine gemütliche Lichtstimmung und werden zum schicken Wohnraumaccessoire.

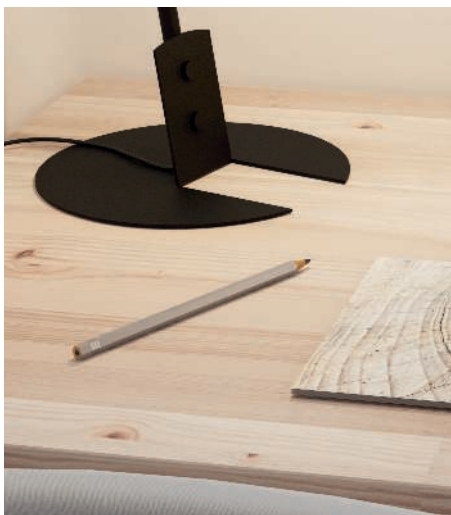































NOUS NOUS TENONS EN PLEINE LUMIÈRE

La gamme de luminaires de table et lampadaires est formée de différents styles et persuade par ses multiples possibilités d'application. Les lampes donnent à votre intérieur une lumière conviviale et se transforment en des accessoires d'habitat chics.



OVERVIEW

TABLE & FLOOR LUMINAIRES

 FONDACHELLI p. 760	 NOSINO p. 761	 ESTAZIONA p. 761	 CONESA p. 762	 ESPARTAL p. 763	 NADINA p. 763	 REKALDE p. 764	 ONEDA p. 764
 CORTADERAS p. 765	 ARANZOLA p. 765	 BELESER p. 766	 BUDENSEA p. 766	 CARBONERAS p. 767	 PICACHA p. 767	 BARBOTTO p. 768	 DARNIUS p. 768
 BORGILLIO p. 769	 UP 2 p. 770-771	 BAYA LED p. 772-773	 SARRIONE p. 774	 BAYA p. 774	 VILLABATE 1 p. 776-777	 PASTERI p. 777	 CARLTON 2 p. 778
 PEDREGAL 1 p. 779	 CHIETINO 1 p. 780	 MANALBA 1 p. 781	 MANALBA p. 781	 BELLARIVA p. 782	 BELLARIVA 3 p. 783	 TRONDIO p. 783	 TAREGA p. 783
 CAHUAMA p. 784	 BATISTA 3 p. 785	 TURIALDO 1 p. 785	 SWARBY p. 785	 MURNIA p. 786	 PETTO 1 p. 787	 BATABANO p. 787	 ERMUA p. 787
 AMEZAGA p. 788	 MARYVILLA p. 788	 SARONA p. 788	 MANTUNALLE p. 790	 CASTELLATO p. 790	 BILBANA p. 790	 OLIVAL 1 p. 791	 SOLO 2 p. 791
 SOLO 1 p. 792	 SOLO p. 793	 DAMASCO 1 p. 793-794	 SLIM p. 793	 GEO p. 795	 NARANJO p. 797	 DESIERTO p. 797	



This product is available in different colors and shapes./ Dieser Artikel ist in unterschiedlichen Farben und Formen verfügbar.
Cet article est disponible en différentes couleurs et formes.





95539



95541



900187

95539 FONDACHELLI

floor light; steel, satin nickel / fabric, white, silver
 Stehleuchte; Stahl, nickel-matt / Textil, weiss, silber
 lampadaire; acier, nickel mat / tissu, blanc, argent

H 1515, Ø 510



E27 1x 60W



9 002759 955397

95541 FONDACHELLI

floor light; steel, black / fabric, black, copper
 Stehleuchte; Stahl, schwarz / Textil, schwarz, kupfer
 lampadaire; acier, noir / tissu, noir, cuivre

H 1515, Ø 510

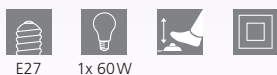

E27 1x 60W



9 002759 955410

900187 FONDACHELLI

floor light; steel, black / fabric, linen, grey
 Stehleuchte; Stahl, schwarz / Textil, Leinen, grau
 lampadaire; acier, noir / tissu, lin, gris

H 1515, Ø 510



E27 1x 60W



9 008606 234479



99101



99015

99101 NOSINO

table light; steel, black / fabric, white
Tischleuchte; Stahl, schwarz / Textil, weiss
luminaire de table; acier, noir / tissu, blanc

H 580, Ø 220, Base: Ø 220

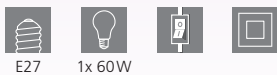

E27 1x 60W



9 002759 991012

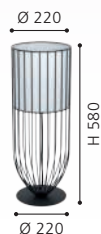

99015 ESTAZIONA

floor light; steel, black / fabric, black
Stehleuchte; Stahl, schwarz / Textil, schwarz
lampadaire; acier, noir / tissu, noir

L 260, B 235, H 1500, Base: Ø 245

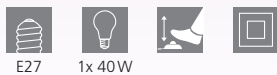

E27 1x 40W



9 002759 990152

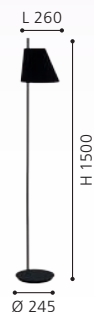



95686



98309

LED

95686 CONESA

floor light; steel, satin nickel / fabric, glass, white
 Stehleuchte; Stahl, nickel-matt / Textil, Glas, weiss
 lampadaire; acier, nickel mat / tissu, verre, blanc

H 1700, Ø 380, Base: Ø 230



E27



1x 60W



E14



1x 40W



9 002759 956868





92206

98309 ESPARTAL

floor light; steel, aluminium, satin nickel, aluminium / fabric, white

Stehleuchte; Stahl, Alu, nickel-matt, alu / Textil, weiss
 lampadaire; acier, aluminium, nickel mat, aluminium / tissu, blanc

H 1485, Ø 250, Base: Ø 250



9 002759 983093



92206 NADINA

floor light; steel, satin nickel / fabric with hoop-and-loop tape, white

Stehleuchte; Stahl, nickel-matt / Textil mit Klettverschluss, weiss
 lampadaire; acier, nickel mat / tissu avec fermeture velcro, blanc

L 1790, B 380, H 1950, Base: Ø 320

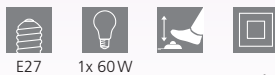

9 002759 922061





98674



900393



900394

98674 REKALDE

floor light; steel, black, white
Stehleuchte; Stahl, schwarz, weiss
lampadaire; acier, noir, blanc

L 290, B 160, H 1500, Base: Ø 250



E27 1x 40W



9 002759 986742

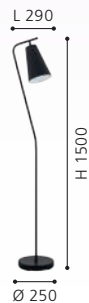

900393 ONEDA

table light; steel, black, white
Tischleuchte; Stahl, schwarz, weiss
luminaire de table; acier, noir, blanc

L 290, B 145, H 445, Base: Ø 210



E27 1x 40W



9 008606 243716



900394 ONEDA

floor light; steel, black, white
Stehleuchte; Stahl, schwarz, weiss
lampadaire; acier, noir, blanc

L 540, B 200, H 1605, Base: Ø 315



E27 1x 40W



9 008606 243723





97806

LED



900134



900135

97806 CORTADERAS

floor light; steel, black, gold
Stehleuchte; Stahl, schwarz, gold
lampadaire; acier, noir, or

H 1445, Ø 250, Base: Ø 250



9 002759 978068



900134 ARANZOLA

table light; steel, black, white
Tischleuchte; Stahl, schwarz, weiss
luminaire de table; acier, noir, blanc

H 450, Ø 300, Base: Ø 115



9 008606 240012



900135 ARANZOLA

floor light; steel, black, white
Stehleuchte; Stahl, schwarz, weiss
lampadaire; acier, noir, blanc

L 300, H 1635, Base: Ø 300

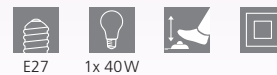

9 008606 240029

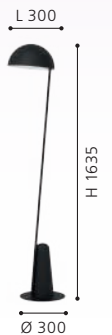



DESIGN
HIGHLIGHT
DETAIL

EGLO
RECOMMENDS
110003
BELESER

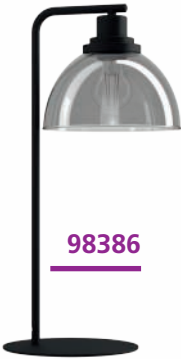

98386



98387



99113

LED

98386 BELESER

table light; steel, black / glass vaporized, black-transparent
Tischleuchte; Stahl, schwarz / Glas bedampft, schwarz-transparent
luminaire de table; acier, noir / verre vaporisé, noir transparent

L 265, B 205, H 505, Base: Ø 200



9 002759 983864



98387 BELESER

floor light; steel, black / glass vaporized, black-transparent
Stehleuchte; Stahl, schwarz / Glas bedampft, schwarz-transparent
lampadaire; acier, noir / verre vaporisé, noir transparent

L 260, B 205, H 1505, Base: Ø 220



9 002759 983871



99113 BUDENSEA

floor light; cast aluminium, black, white
Stehleuchte; Aluguss, schwarz, weiss
lampadaire; fonte d'aluminium, noir, blanc

L 365, B 250, H 1800, Base: B 300, T 250

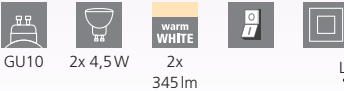

9 002759 991135

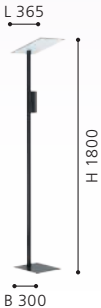



99822

LED

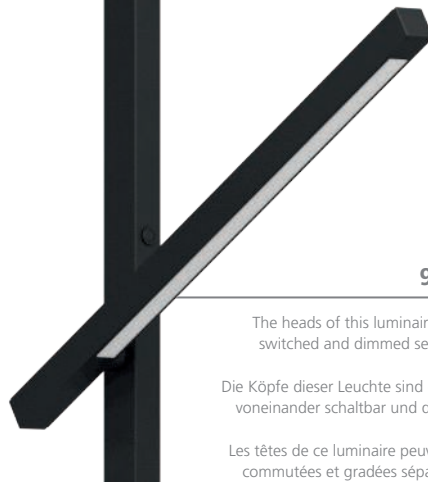

99882

The heads of this luminaire can be switched and dimmed separately.

Die Köpfe dieser Leuchte sind getrennt voneinander schaltbar und dimmbar.

Les têtes de ce luminaire peuvent être commutées et gradées séparément.



99113

This lamp is rotatable.

Diese Leuchte ist drehbar.

Cette lampe est rotative.

0-180°

0-80°

99822 CARBONERAS

floor light; steel, black / plastic, transparent
 Stehleuchte; Stahl, schwarz / Kunststoff, transparent
 lampadaire; acier, noir / plastique, transparent

L 400, B 250, H 1800, Base: B 330, T 240



6x 3,8W 2400lm 7W 750lm



9 002759 998226

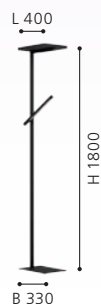

99715 PICACHA

floor light; steel, black / plastic, white
 Stehleuchte; Stahl, schwarz / Kunststoff, weiss
 lampadaire; acier, noir / plastique, blanc

H 1625, Base: B 150, T 150



29W 3500lm

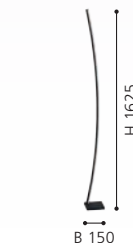

9 002759 997151



99715

LED



97583

LED



97584

LED



98458

97583 BARBOTTO

table light; steel, black, gold
Tischleuchte; Stahl, schwarz, gold
luminaire de table; acier, noir, or

H 395, Ø 60, Base: Ø 100



GU10



1x 4,5W



1x

345lm



9 002759 975838



97584 BARBOTTO

floor light; steel, black, gold
Stehleuchte; Stahl, schwarz, gold
lampadaire; acier, noir, or

H 1370, Ø 60, Base: Ø 185



GU10



1x 4,5W



1x

345lm



9 002759 975845



98458 DARNIUS

floor light; steel, black, gold
Stehleuchte; Stahl, schwarz, gold
lampadaire; acier, noir, or

H 1420, Ø 380, Base: Ø 645



E27



1x 40W



9 002759 984588

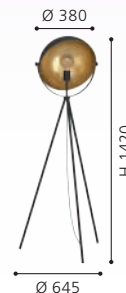

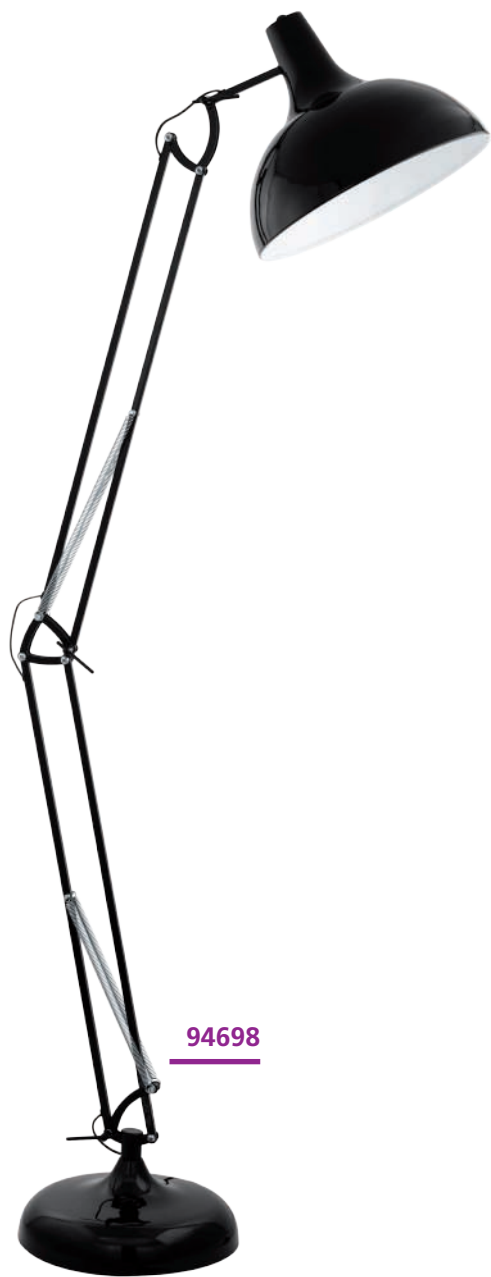

94698



94705

94698 BORGILLIO

floor light; steel, black
Stehleuchte; Stahl, schwarz
lampadaire; acier, noir

L 380, H 1900, Base: Ø 340

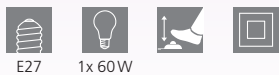

E27 1x 60W

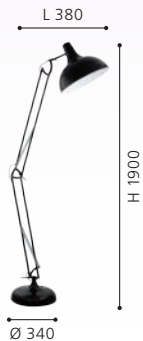

9 002759 946982

94705 BORGILLIO

floor light; steel, copper
Stehleuchte; Stahl, kupfer
lampadaire; acier, cuivre

L 380, H 1900, Base: Ø 340

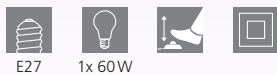

E27 1x 60W

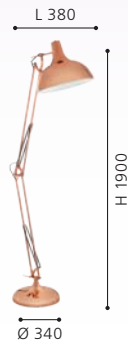

9 002759 947057



93917



82842



82843

93917 UP 2

floor light; steel, nickel-nero / plastic, glass, white
 Stehleuchte; Stahl, nickel-nero / Kunststoff, Glas, weiss
 lampadaire; acier, nickel noir / plastique, verre, blanc

H 1765, Ø 275, Base: Ø 230

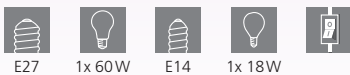

9 002759 939175



82842 UP 2

floor light; steel, satin nickel / plastic, glass, white
 Stehleuchte; Stahl, nickel-matt / Kunststoff, Glas, weiss
 lampadaire; acier, nickel mat / plastique, verre, blanc

H 1765, Ø 275, Base: Ø 230



9 002759 828424



82843 UP 2

floor light; steel, brass-matt / plastic, glass, white
 Stehleuchte; Stahl, messing-matt / Kunststoff, Glas, weiss
 lampadaire; acier, laiton mat / plastique, verre, blanc

H 1765, Ø 275, Base: Ø 230

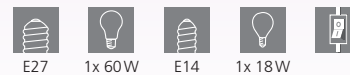

9 002759 828431





82844

DESIGN
HIGHLIGHT
DETAIL



82844 UP 2

floor light; steel, bronzed / plastic, glass, white
Stehleuchte; Stahl, brüniert / Kunststoff, Glas, weiss
lampadaire; acier, brun / plastique, verre, blanc

H 1765, Ø 275, Base: Ø 230



E27



1x 60W



E14



1x 18W



9 002759 828448





93877



93876



93875



93877 BAYA LED

floor light; steel, brass / glass, plastic, white, satiné
 Stehleuchte; Stahl, messing / Glas, Kunststoff, weiss, satiniert
 lampadaire; acier, laiton / verre, plastique, blanc, satiné

L 360, H 1800, Base: Ø 250

LED 20W warm WHITE 1950lm LED 2,5W warm WHITE 240lm LED 2,5W

warm WHITE 250lm



9 002759 938772



93876 BAYA LED

floor light; steel, bronzed / glass, plastic, white, satiné
 Stehleuchte; Stahl, brüniert / Glas, Kunststoff, weiss, satiniert
 lampadaire; acier, brun / verre, plastique, blanc, satiné

L 360, H 1800, Base: Ø 250

LED 20W warm WHITE 1950lm LED 2,5W warm WHITE 240lm LED 2,5W

warm WHITE 250lm



9 002759 938765



93875 BAYA LED

floor light; steel, chrome / glass, plastic, white, satiné
 Stehleuchte; Stahl, chrom / Glas, Kunststoff, weiss, satiniert
 lampadaire; acier, chrome / verre, plastique, blanc, satiné

L 360, H 1800, Base: Ø 250

LED 20W warm WHITE 1950lm LED 2,5W warm WHITE 240lm LED 2,5W

warm WHITE 250lm



9 002759 938758





DESIGN
HIGHLIGHT
DETAIL



93874

LED

93874 BAYA LED

floor light; steel, satin nickel / glass, plastic, white, satined
Stehleuchte; Stahl, nickel-matt / Glas, Kunststoff, weiss, satiniert
lampadaire; acier, nickel mat / verre, plastique, blanc, satiné

L 360, H 1800, Base: Ø 250

- LED**
20W
- warm WHITE**
2200lm
- LED**
2,5W
- warm WHITE**
250lm
- LED**
2,5W

- warm WHITE**
250lm
-
-
-
-
-

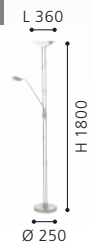



DESIGN
HIGHLIGHT
DETAIL



93713
LED



85974

93713 SARRIONE
floor light; steel, satin nickel / plastic, satined
Stehleuchte; Stahl, nickel-matt / Kunststoff, satiniert
lampadaire; acier, nickel mat / plastique, satiné

85974 BAYA
floor light; steel, bronzed / satin glass, white
Stehleuchte; Stahl, brüniert / Glas satiniert, weiss
lampadaire; acier, brun / verre satiné, blanc

85971 BAYA
floor light; steel, satin nickel / satin glass, white
Stehleuchte; Stahl, nickel-matt / Glas satiniert, weiss
lampadaire; acier, nickel mat / verre satiné, blanc

H 1800, Base: Ø 250

LED 17W warm WHITE 1900lm
LED 3W warm WHITE 340lm
LED 4,5W

warm WHITE 500lm



9 002759 937133

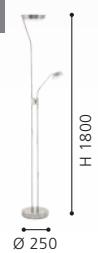

L 440, H 1800, Base: Ø 280

R7S 1x 230W G9 1x 33W



9 002759 859749

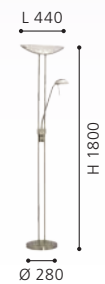

L 440, H 1800, Base: Ø 280

R7S 1x 230W G9 1x 33W



9 002759 859718

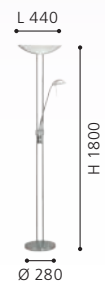



85971



99103

99103 VILLABATE 1

table light; steel, black / fabric, black, white
Tischleuchte; Stahl, schwarz / Textil, schwarz, weiss
luminaire de table; acier, noir / tissu, noir, blanc

L 185, B 160, H 175



E27



1x 25W





99104



95726



95725

99104 VILLABATE 1

table light; steel, satin nickel / fabric, taupe, white
Tischleuchte; Stahl, nickel-matt / Textil, taupe, weiss
luminaire de table; acier, nickel mat / tissu, taupe, blanc

L 185, B 160, H 175



E27 1x 25W



9 002759 991043



95726 PASTERI

table light; steel, satin nickel / fabric, taupe
Tischleuchte; Stahl, nickel-matt / Textil, taupe
luminaire de table; acier, nickel mat / tissu, taupe

H 275, Ø 140, Base: Ø 120



E14 1x 40W



9 002759 957261



95725 PASTERI

table light; steel, satin nickel / fabric, white
Tischleuchte; Stahl, nickel-matt / Textil, weiss
luminaire de table; acier, nickel mat / tissu, blanc

H 275, Ø 140, Base: Ø 120



E14 1x 40W



9 002759 957254



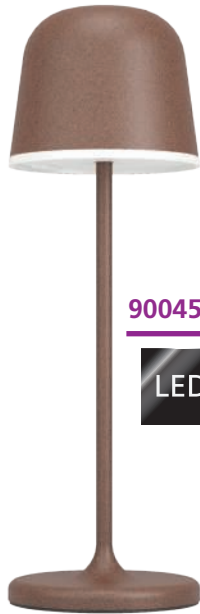

900459

LED

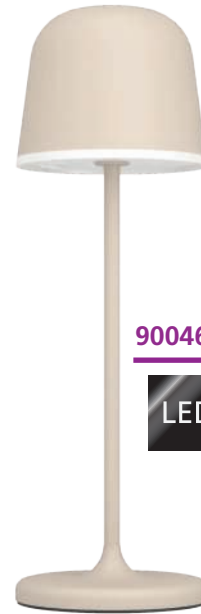

900461

LED



900457

LED

900459 MANNERA

table light; aluminium, steel, auburn / plastic, white
Tischleuchte; Alu, Stahl, rostbraun / Kunststoff, weiss
luminaire de table; aluminium, acier, brun rouille / plastique, blanc

H 340, Ø 110, Base: Ø 110

LED 2,2W warm WHITE 200lm ACCU Li-ion 1800mAh

IP54



9 008606 244003

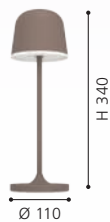

900457 MANNERA

table light; aluminium, steel, black / plastic, white
Tischleuchte; Alu, Stahl, schwarz / Kunststoff, weiss
luminaire de table; aluminium, acier, noir / plastique, blanc

H 340, Ø 110, Base: Ø 110

LED 2,2W warm WHITE 200lm ACCU Li-ion 1800mAh

IP54



9 008606 243990



900461 MANNERA

table light; aluminium, steel, sandy / plastic, white
Tischleuchte; Alu, Stahl, sandfarben / Kunststoff, weiss
luminaire de table; aluminium, acier, couleur sable / plastique, blanc

H 340, Ø 110, Base: Ø 110

LED 2,2W warm WHITE 200lm ACCU Li-ion 1800mAh

IP54



9 008606 243983

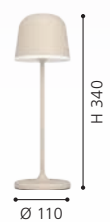



900458

LED

900458 MANNERA

table light; aluminium, steel, grey / plastic, white

Tischleuchte; Alu, Stahl, grau / Kunststoff, weiss

luminaire de table; aluminium, acier, gris / plastique, blanc

H 340, Ø 110, Base: Ø 110



2,2W



200lm



Li-ion



1800 mAh



IP54



9 008606 243976

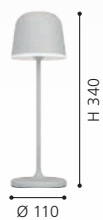



95789



95787



95788

95789 CARLTON 2

table light; steel, black / fabric, white
Tischleuchte; Stahl, schwarz / Textil, weiss
luminaire de table; acier, noir / tissu, blanc

H 305, Ø 165, Base: Ø 95

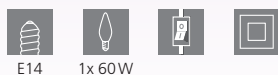

E14 1x 60W



9 002759 957896



95787 CARLTON 2

table light; steel, copper / fabric, black, copper
Tischleuchte; Stahl, kupfer / Textil, schwarz, kupfer
luminaire de table; acier, cuivre / tissu, noir, cuivre

H 305, Ø 165, Base: Ø 95



E14 1x 60W



9 002759 957872



95788 CARLTON 2

table light; steel, brass / fabric, black, gold
Tischleuchte; Stahl, messing / Textil, schwarz, gold
luminaire de table; acier, laiton / tissu, noir, or

H 305, Ø 165, Base: Ø 95



E14 1x 60W



9 002759 957889





95185

95185 PEDREGAL 1

table light; steel, copper / fabric, black, copper
Tischleuchte; Stahl, kupfer / Textil, schwarz, kupfer
luminaire de table; acier, cuivre / tissu, noir, cuivre

H 645, Ø 350, Base: Ø 300



E27



1x 60W



9 002759 951856

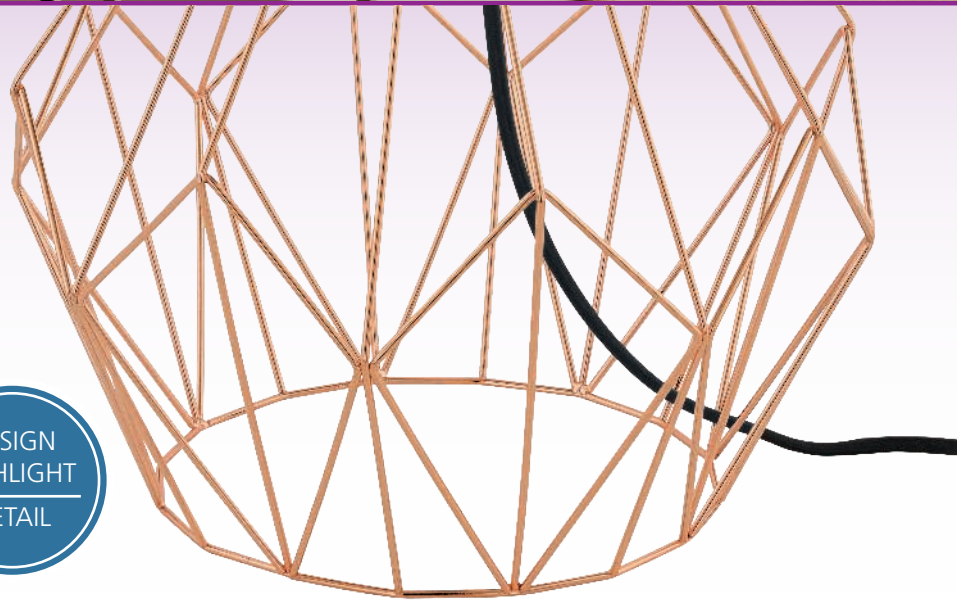
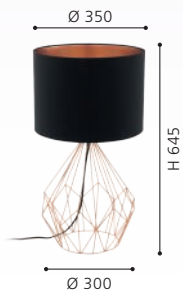



97516

97516 CHIETINO 1

table light; wood, steel, natural, chrome / fabric, white
Tischleuchte; Holz, Stahl, natur, chrom / Textil, weiss
luminaire de table; bois, acier, naturel, chrome / tissu, blanc

H 440, Ø 260, Base: B 235, T 235



E27



1x 60W





99329



99331



95386

99329 MANALBA 1

table light; ceramic, silver / fabric, white, silver
Tischleuchte; Keramik, silber / Textil, weiss, silber
luminaire de table; céramique, argent / tissu, blanc, argent

H 300, Ø 200, Base: Ø 125



E14 1x 40W



9 002759 993290



99331 MANALBA 1

table light; ceramic, gold-coloured / fabric, black, gold
Tischleuchte; Keramik, goldfarben / Textil, schwarz, gold
luminaire de table; céramique, or / tissu, noir, or

H 300, Ø 200, Base: Ø 125



E14 1x 40W



9 002759 993313



95386 MANALBA

table light; steel, gold / fabric, black, gold
Tischleuchte; Stahl, gold / Textil, schwarz, gold
luminaire de table; acier, or / tissu, noir, or

H 380, Ø 250, Base: Ø 160

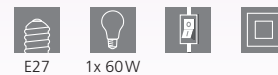

E27 1x 60W



9 002759 953867





97774



97773



97774 BELLARIVA

table light; ceramic, grey / fabric, white
Tischleuchte; Keramik, grau / Textil, weiss
luminaire de table; céramique, gris / tissu, blanc

H 320, Ø 150, Base: Ø 120



E14 1x 40W



97773 BELLARIVA

table light; ceramic, creme-white / fabric, white
Tischleuchte; Keramik, creme-weiss / Textil, weiss
luminaire de table; céramique, blanc crème / tissu, blanc

H 320, Ø 150, Base: Ø 120



E14 1x 40W





99332



93046



95527

99332 BELLARIVA 3

table light; ceramic, white / fabric, linen, light brown
Tischleuchte; Keramik, weiss / Textil, Leinen, hellbraun
luminaire de table; céramique, blanc / tissu, lin, marron transparent

H 360, Ø 200, Base: Ø 160



E27 1x 40W



9 002759 993320



93046 TRONDIO

table light; ceramic, white / fabric, white
Tischleuchte; Keramik, weiss / Textil, weiss
luminaire de table; céramique, blanc / tissu, blanc

H 270, Ø 150, Base: Ø 120



E14 1x 40W



9 002759 930462



95527 TAREGA

table light; wood, concrete, brown, grey / fabric, brown
Tischleuchte; Holz, Beton, braun, grau / Textil, braun
luminaire de table; bois, béton, marron, gris / tissu, marron

H 370, Ø 250, Base: Ø 150

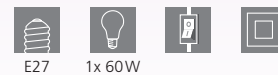

E27 1x 60W



9 002759 955274





99824



99825

99824 CAHUAMA

table light; ceramic, light brown / glass, white
Tischleuchte; Keramik, hellbraun / Glas, weiss
luminaire de table; céramique, marron clair / verre, blanc

H 300, Ø 275, Base: Ø 105



E27 1x 40W



9 002759 998240



99825 CAHUAMA

table light; ceramic, white, black / glass, grey matt
Tischleuchte; Keramik, weiss, schwarz / Glas, grau matt
luminaire de table; céramique, blanc, noir / verre, gris mat

H 300, Ø 275, Base: Ø 105



E27 1x 40W



9 002759 998257

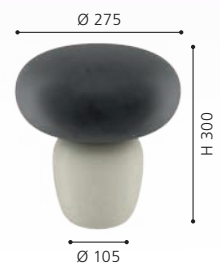



97589



97589



900334



98859

97589 BATISTA 3

table light; steel, satin nickel / glass wiping technique, white
Tischleuchte; Stahl, nickel-matt / Glas Wischtechnik, weiss
luminaire de table; acier, nickel mat / technique de verre essuyé, blanc

H 225, Ø 120, Base: Ø 110



900334 TURIALDO 1

table light; wood, steel, black
Tischleuchte; Holz, Stahl, schwarz
luminaire de table; bois, acier, noir

H 100, Ø 85



98859 SWARBY

table light; cement, grey
Tischleuchte; Zement, grau
luminaire de table; ciment, gris

H 120, Ø 100

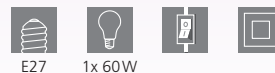



900314



DESIGN
HIGHLIGHT
DETAIL



900314 MURNIA

table light; steel, black, white
Tischleuchte; Stahl, schwarz, weiss
luminaire de table; acier, noir, blanc

L 190, B 165, H 430, Base: Ø 165



E14



1x 40W



9 008606 235421





94513

LED



900396



98837

LED



DESIGN
HIGHLIGHT
DETAIL

94513 PETTO 1

table light; steel, white
Tischleuchte; Stahl, weiss
luminaire de table; acier, blanc

H 135, Ø 105, Base: Ø 90



900396 BATABANO

table light; steel, sandy, black
Tischleuchte; Stahl, sandfarben, schwarz
luminaire de table; acier, couleur sable, noir

H 275, Ø 180, Base: Ø 160



98837 ERMUA

table light; steel, wood, black, brown / plastic, white
Tischleuchte; Stahl, Holz, schwarz, braun / Kunststoff, weiss
luminaire de table; acier, bois, noir, marron / plastique, blanc

L 330, B 165, H 505, Base: B 240, T 160





98864



900552

98864 AMEZAGA

table light; steel, black, brass
Tischleuchte; Stahl, schwarz, messing
luminaire de table; acier, noir, laiton

L 355, B 160, H 575, Base: Ø 170



E27 1x 10W



9 002759 988647

900552 MARYVILLA

table light; steel, bronzed / glass vaporized, clear, gold
Tischleuchte; Stahl, brüniert / Glas bedampft, klar, gold
luminaire de table; acier, brun / verre vaporisé, transparent, or

H 230, Ø 170, Base: Ø 130



E27 1x 40W



9 008606 244577

900403 SARONA

table light; steel, black, gold
Tischleuchte; Stahl, schwarz, gold
luminaire de table; acier, noir, or

H 315, Ø 140, Base: B 140



GU10 1x 4,5W 1x 345lm



9 008606 243785





900403



LED

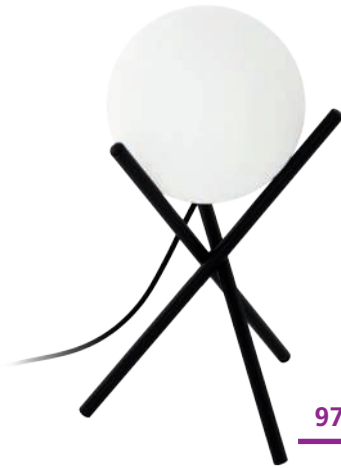

99369 MANTUNALLE

table light; steel, black / glass, white
Tischleuchte; Stahl, schwarz / Glas, weiss
luminaire de table; acier, noir / verre, blanc

H 400, Ø 200, Base: Ø 220



97333 CASTELLATO

table light; steel, black / glass opal-matt, white
Tischleuchte; Stahl, schwarz / Glas opal-matt, weiss
luminaire de table; acier, noir / verre opale mat, blanc

H 330, Ø 210

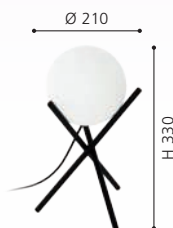
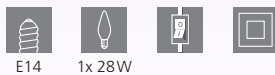

900358 BILBANA

table light; steel, black / glass opal-matt, white
Tischleuchte; Stahl, schwarz / Glas opal-matt, weiss
luminaire de table; acier, noir / verre opale mat, blanc

L 145, B 135, H 195, Base: B 135, T 115

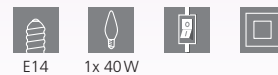



97209 OLIVAL 1

table light; steel, black / smoked glass, black-transparent
Tischleuchte; Stahl, schwarz / Rauchglas, schwarz-transparent
luminaire de table; acier, noir / verre fumé, noir transparent

L 200, B 200, H 305



900141 SOLO 2

table light; steel, black / glass vaporized, black-transparent
Tischleuchte; Stahl, schwarz / Glas bedampft, schwarz-transparent
luminaire de table; acier, noir / verre vaporisé, noir transparent

H 415, Ø 260, Base: Ø 180

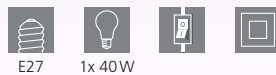

900142 SOLO 2

table light; steel, black / glass etched, white
Tischleuchte; Stahl, schwarz / Glas geätzt, weiss
luminaire de table; acier, noir / verre gravé, blanc

H 415, Ø 260, Base: Ø 180





87254



87256



85104

87254 SOLO 1

table light; steel, brass-matt / satin glass, white
Tischleuchte; Stahl, messing-matt / Glas satiniert, weiss
luminaire de table; acier, laiton mat / verre satiné, blanc

H 350, Ø 260, Base: Ø 130

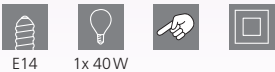

E14 1x 40W



9 002759 872540



87256 SOLO 1

table light; steel, wood, bronzed, nut / satin glass, white
Tischleuchte; Stahl, Holz, brüniert, Nuss / Glas satiniert, weiss
luminaire de table; acier, bois, brun, noisette / verre satiné, blanc

H 350, Ø 260, Base: Ø 130



E14 1x 40W



9 002759 872564



85104 SOLO 1

table light; steel, satin nickel / satin glass, white
Tischleuchte; Stahl, nickel-matt / Glas satiniert, weiss
luminaire de table; acier, nickel mat / verre satiné, blanc

H 350, Ø 260, Base: Ø 130

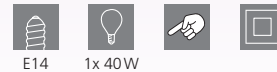

E14 1x 40W



9 002759 851040





91238



95785



95785



82305



82305

91238 SOLO

table light; steel, satin nickel / satin glass, white with decor
Tischleuchte; Stahl, nickel-matt / Glas satiniert, weiss m. Dekor
luminaire de table; acier, nickel mat / verre satiné, blanc avec décor

H 320, Ø 265, Base: Ø 130

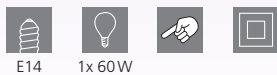

E14 1x 60W



9 002759 912383



95785 DAMASCO 1

table light; steel, satin nickel / glass opal-matt, white
Tischleuchte; Stahl, nickel-matt / Glas opal-matt, weiss
luminaire de table; acier, nickel mat / verre opale mat, blanc

H 300, Ø 145, Base: Ø 120



E14 1x 60W



9 002759 957858



82305 SLIM

table light; steel, satin nickel / glass, white
Tischleuchte; Stahl, nickel-matt / Glas, weiss
luminaire de table; acier, nickel mat / verre, blanc

H 220, Ø 70, Base: Ø 100

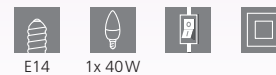

E14 1x 40W



9 002759 823054





95775 | 95776 | 81828



95775



95776



98887

95775 DAMASCO 1

table light; steel, satin nickel / satin glass, white
Tischleuchte; Stahl, nickel-matt / Glas satiniert, weiss
luminaire de table; acier, nickel mat / verre satiné, blanc

H 215, Ø 100



9 002759 957759



95776 DAMASCO 1

table light; steel, chrome / satin glass, white
Tischleuchte; Stahl, chrom / Glas satiniert, weiss
luminaire de table; acier, chrome / verre satiné, blanc

H 215, Ø 100



9 002759 957766



98887 DAMASCO 1

table light; steel, black / glass vaporized, black-transparent
Tischleuchte; Stahl, schwarz / Glas bedampft, schwarz-transparent
luminaire de table; acier, noir / verre vaporisé, noir transparent

H 310, Ø 100



9 002759 988876

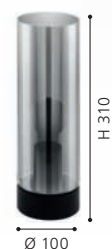



81827 | 91242



81827



81828



91242

81827 GEO

table light; glass, plastic, white
Tischleuchte; Glas, Kunststoff, weiss
luminaire de table; verre, plastique, blanc

H 200, Ø 100, Base: Ø 100

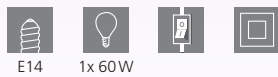

E14 1x 60W



9 002759 818272



81828 GEO

table light; glass opal-matt, white
Tischleuchte; Glas opal-matt, weiss
luminaire de table; verre opale mat, blanc

H 350, Ø 120, Base: Ø 120

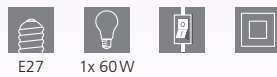

E27 1x 60W



9 002759 818289



91242 GEO

table light; glass, plastic, white
Tischleuchte; Glas, Kunststoff, weiss
luminaire de table; verre, plastique, blanc

H 200, Ø 100

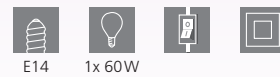

E14 1x 60W



9 002759 912420





99597
LED

DESIGN
HIGHLIGHT
DETAIL



99794



99597 NARANJO

table light; steel, black / glass, clear
Tischleuchte; Stahl, schwarz / Glas, klar
luminaire de table; acier, noir / verre, transparent

L 450, B 430, H 555



4x 4,1 W 1520lm



9 002759 995973



99794 DESIERTO

table light; steel, wood, black, brown
Tischleuchte; Stahl, Holz, schwarz, braun
luminaire de table; acier, bois, noir, marron

H 540, Ø 450, Base: Ø 330



E27 1x 40W



9 002759 997946



OFFICE TABLE & FLOOR LUMINAIRES

BÜRO TISCH- & STEHLEUCHTEN

LUMINAIRES DE TABLE & LAMPADAIRES À BUREAU

WE LOVE LIGHT

The range of office table and floor luminaires is made up of many different styles and convinces with its diverse uses.

WIR STEHEN AUF LICHT

Das Sortiment der Büro Tisch- und Stehleuchten setzt sich aus unterschiedlichen Stilen zusammen und überzeugt mit seinen vielseitigen Einsatzmöglichkeiten.



NOUS NOUS TENONS EN PLEINE LUMIÈRE

La gamme d'éclairages de table et sur pieds à bureau est formée de différents styles et persuade par ses multiples possibilités d'application.



OVERVIEW

OFFICE TABLE & FLOOR LUMINAIRES



TRUNCA
p. 802



MASSERIE
p. 802



ARENAZA
p. 803



BANDERALO
p. 804



CASIBARE-QI
p. 805



LACEY-QI
p. 805



VERADAL-QI
p. 805



SELLANO
p. 806



LA SECA
p. 807



CAUPO
p. 808



BROLINI
p. 809



COGNOLI
p. 810



LAROA
p. 812-813



CEPPINO
p. 814



VERADAL
p. 814-815



DURENGO
p. 816



DAMBERA
p. 816



SNAPORA
p. 816



GEXO
p. 818



CABALES
p. 818-819



CABADO 1
p. 820



CAJERO
p. 820-821



TABILLANO 1
p. 822



TORONA 1
p. 822



BORGILLO
p. 824-825



BANKER
p. 826



FIRMO
p. 827



BASIC 1
p. 828



BASIC
p. 828-829



FOX
p. 830



This product is available in different colors and shapes./ Dieser Artikel ist in unterschiedlichen Farben und Formen verfügbar.
Cet article est disponible en différentes couleurs et formes.



98093, 98247, 99828, 99829

These luminaires have a Qi charging function. They can wirelessly charge Qi-compatible Smartphones by inductive energy transfer.

Diese Leuchten besitzen eine Qi-Ladefunktion. Damit können Qi-kompatible Smartphones über induktive Energieübertragung kabellos geladen werden.

Ces luminaires disposent d'une fonction de chargement Qi. Cela permet aux smartphones compatibles Qi d'être chargés sans fil par transmission d'énergie inductive.



98093 TRUNCA

table light; plastic, white

Tischleuchte; Kunststoff, weiss

luminaire de table; plastique, blanc

H 485, Base: B 185, T 185

LED
4W

tunable
WHITE
450lm



9 002759 980931



98247 MASSERIE

table light; plastic, white

Tischleuchte; Kunststoff, weiss

luminaire de table; plastique, blanc

H 385, Base: B 165, T 165

LED
3,4W

neutral
WHITE
460lm



9 002759 982478





99828

LED



99829

LED



99828 ARENAZA

table light; steel, plastic, white, black
Tischleuchte; Stahl, Kunststoff, weiss, schwarz
luminaire de table; acier, plastique, blanc, noir

L 240, B 130, H 320, Base: B 240, T 120

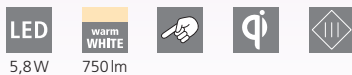

9 002759 998288



99829 ARENAZA

table light; steel, plastic, black
Tischleuchte; Stahl, Kunststoff, schwarz
luminaire de table; acier, plastique, noir

L 240, B 130, H 320, Base: B 240, T 120

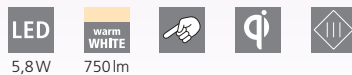

9 002759 998295





99831

LED

Qi Fast
Charger



99832

LED

Qi Fast
Charger



DESIGN
HIGHLIGHT
DETAIL

99831 BANDERALO

table light; plastic, white
Tischleuchte; Kunststoff, weiss
luminaire de table; plastique, blanc

L 305, B 170, H 405, Base: Ø 170

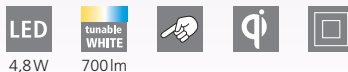

99832 BANDERALO

table light; plastic, black
Tischleuchte; Kunststoff, schwarz
luminaire de table; plastique, noir

L 305, B 170, H 405, Base: Ø 170

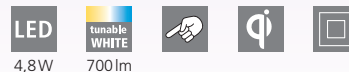



900626

LED



900628

LED

900626 LACEY-QI

table light; steel, wood, black, brown / steel, black, creme
 Tischleuchte; Stahl, Holz, schwarz, braun / Stahl, schwarz, creme
 luminaire de table; acier, bois, noir, marron / acier, noir, crème

L 255, B 135, H 485, Base: B 190, T 130

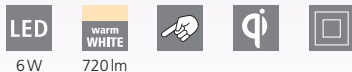

900628 VERADAL-QI

table light; wood, plastic, black, brown / steel, black
 Tischleuchte; Holz, Kunststoff, schwarz, braun / Stahl, schwarz
 luminaire de table; bois, plastique, noir, marron / acier, noir

B 125, H 490, Base: Ø 160

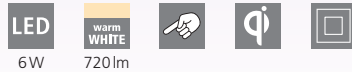



93901

LED

93901

The touch buttons can be used to dim the luminaire and adjust the light colour.

Über die Berührungsschalter kann man die Leuchte dimmen und die Lichtfarbe einstellen.

Les boutons tactiles peuvent être utilisés pour dimmer et régler la couleur de la lumière.



93901 SELLANO

table light; plastic, steel, white, black
 Tischleuchte; Kunststoff, Stahl, weiss, schwarz
 luminaire de table; plastique, acier, blanc, noir

H 430, Base: B 180, T 180

LED
4W

tunable
WHITE
450lm



9 002759 939014





97044

LED



97045

LED



LA SECA

These luminaires have a USB port for charging and operating the luminaires.

Diese Leuchten verfügen über einen USB-Anschluss, der zum Laden und Betrieb der Leuchten dient.

Faites fonctionner et charger ces luminaires grâce au port USB.

97044 LA SECA

table light; plastic, white
Tischleuchte; Kunststoff, weiss
luminaire de table; plastique, blanc

L 200, B 50, H 260, Base: B 70, T 50



1,8W



170lm



Li-ion



1200mAh



9 002759 970444



97045 LA SECA

table light; plastic, black
Tischleuchte; Kunststoff, schwarz
luminaire de table; plastique, noir

L 200, B 50, H 260, Base: B 70, T 50



1,8W



170lm



Li-ion



1200mAh



9 002759 970451



DESIGN
HIGHLIGHT
DETAIL



93966

LED



93965

LED

93966 CAUPO

table light; plastic, steel, black
Tischleuchte; Kunststoff, Stahl, schwarz
luminaire de table; plastique, acier, noir

L 260, H 320, Base: B 150, T 150



2,1W 210lm



9 002759 939663



93965 CAUPO

table light; plastic, steel, white
Tischleuchte; Kunststoff, Stahl, weiss
luminaire de table; plastique, acier, blanc

L 260, H 320, Base: B 150, T 150



2,1W 210lm



9 002759 939656





900529

LED



900528

LED

900529 BROLINI

table light; plastic, white
Tischleuchte; Kunststoff, weiss
luminaire de table; plastique, blanc

H 550, Ø 150, Base: Ø 150

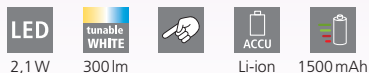

9 008606 242832



900528 BROLINI

table light; plastic, black
Tischleuchte; Kunststoff, schwarz
luminaire de table; plastique, noir

H 550, Ø 150, Base: Ø 150

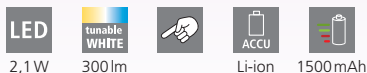

9 008606 242825





DESIGN
HIGHLIGHT
DETAIL



97915

LED

97915 COGNOLI

table light; plastic, white
Tischleuchte; Kunststoff, weiss
luminaire de table; plastique, blanc

L 70, B 100, H 510, Base: B 100, T 70



97914 COGNOLI

table light; plastic, black
Tischleuchte; Kunststoff, schwarz
luminaire de table; plastique, noir

L 70, B 100, H 510, Base: B 100, T 70





97914

LED



96437

LED



96434

LED



96438

LED

96437 LAROA

clamp light; plastic, black
Klemmleuchte; Kunststoff, schwarz
luminaire à pince; plastique, noir

L 450, B 65, H 275

LED

3,5W

neutral
WHITE

400lm



9 002759 964375



96434 LAROA

clamp light; plastic, white
Klemmleuchte; Kunststoff, weiss
luminaire à pince; plastique, blanc

L 450, B 65, H 275

LED

3,5W

neutral
WHITE

400lm



9 002759 964344



96438 LAROA

table light; plastic, black
Tischleuchte; Kunststoff, schwarz
luminaire de table; plastique, noir

L 480, B 120, H 325, Base: B 170, T 120

LED

3,5W

neutral
WHITE

400lm



9 002759 964382





96435

LED

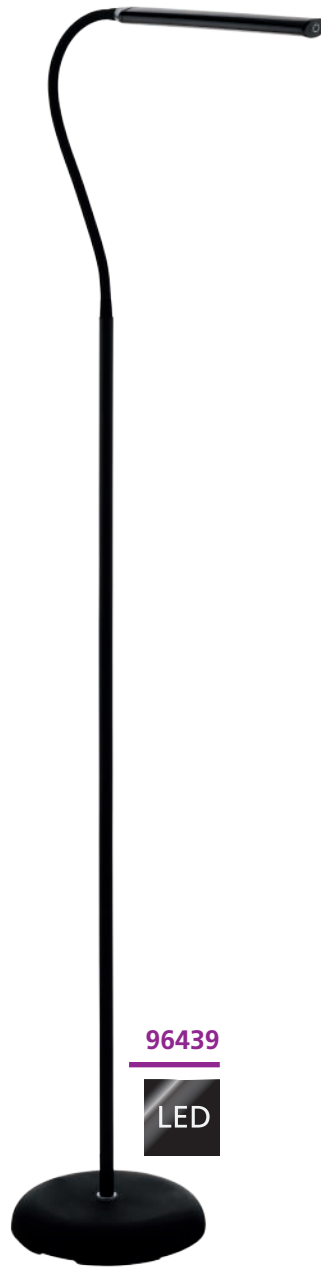

96439

LED



96436

LED

96435 LAROA

table light; plastic, white
Tischleuchte; Kunststoff, weiss
luminaire de table; plastique, blanc

L 480, B 120, H 325, Base: B 170, T 120



3,5W 400lm



9 002759 964351



96439 LAROA

floor light; plastic, black
Stehleuchte; Kunststoff, schwarz
lampadaire; plastique, noir

L 535, B 215, H 1300, Base: Ø 210



3,5W 400lm



9 002759 964399



96436 LAROA

floor light; plastic, white
Stehleuchte; Kunststoff, weiss
lampadaire; plastique, blanc

L 535, B 215, H 1300, Base: Ø 210



3,5W 400lm



9 002759 964368



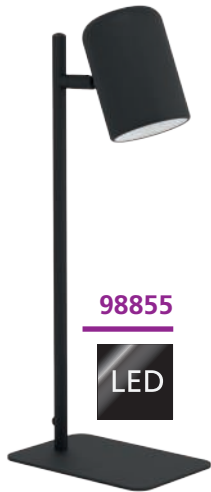

98855

LED

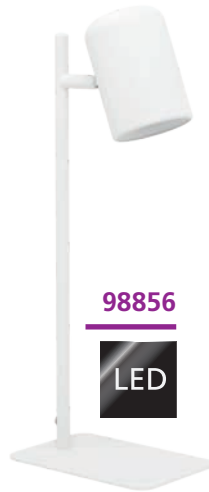

98856

LED



98832



98855 CEPPINO

table light; steel, black, white
Tischleuchte; Stahl, schwarz, weiss
luminaire de table; acier, noir, blanc

H 380, Base: B 165, T 110

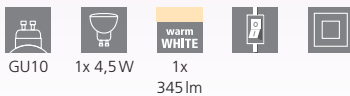

GU10 1x 4,5W 1x 345lm



98856 CEPPINO

table light; steel, white
Tischleuchte; Stahl, weiss
luminaire de table; acier, blanc

H 380, Base: B 165, T 110

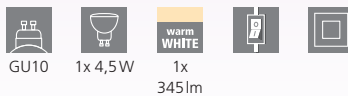

GU10 1x 4,5W 1x 345lm

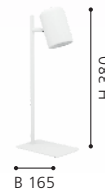

98832 VERADAL

table light; wood, plastic, white, brown / steel, white
Tischleuchte; Holz, Kunststoff, weiss, braun / Stahl, weiss
luminaire de table; bois, plastique, blanc, marron / acier, blanc

B 125, H 490, Base: Ø 160



E27 1x 40W





98831



98831 VERADAL

table light; wood, plastic, black, brown / steel, black
Tischleuchte; Holz, Kunststoff, schwarz, braun / Stahl, schwarz
luminaire de table; bois, plastique, noir, marron / acier, noir

B 125, H 490, Base: Ø 160



E27



1x 40W



9 002759 988319





93078

LED



94673

LED

93078 DURENGO

table light; plastic, steel, white, chrome
Tischleuchte; Kunststoff, Stahl, weiss, chrom
luminaire de table; plastique, acier, blanc, chrome

H 380, Ø 160, Base: Ø 160

LED

warm
WHITE



2,5W

250lm

94673 DAMBERA

table light; plastic, black
Tischleuchte; Kunststoff, schwarz
luminaire de table; plastique, noir

H 375, Base: Ø 170

LED

warm
WHITE



4,5W

660lm

94677 SNAPORA

table light; plastic, aluminium, black
Tischleuchte; Kunststoff, Alu, schwarz
luminaire de table; plastique, aluminium, noir

H 485, Base: Ø 110

LED

warm
WHITE



3W

300lm



9 002759 930783



9 002759 946739



9 002759 946777





94677

LED



93076

LED



93077

LED



99334

LED

93076 GEXO

table light; plastic, steel, black, chrome
Tischleuchte; Kunststoff, Stahl, schwarz, chrom
luminaire de table; plastique, acier, noir, chrome

H 320, Ø 125, Base: Ø 125

LED

warm
WHITE

230lm



9 002759 930769

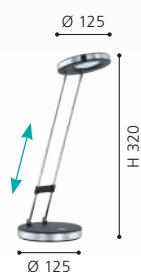

93077 GEXO

table light; plastic, steel, white, chrome
Tischleuchte; Kunststoff, Stahl, weiss, chrom
luminaire de table; plastique, acier, blanc, chrome

H 320, Ø 125, Base: Ø 125

LED

warm
WHITE

230lm



9 002759 930776



99334 CABALES

table light; plastic, white
Tischleuchte; Kunststoff, weiss
luminaire de table; plastique, blanc

H 340, Ø 140, Base: Ø 140

LED

warm
WHITE

490lm



9 002759 993344





99335

LED

99335 CBALES

table light; plastic, black
Tischleuchte; Kunststoff, schwarz
luminaire de table; plastique, noir

H 340, Ø 140, Base: Ø 140



4,6W 490lm





97078

This luminaire has a colored light in the base.
 Diese Leuchte verfügt über ein farbiges Licht im Sockel.
 Cette luminaire a une lumière colorée dans la base.



97078

LED



95695

LED

97078 CABADO 1

table light; plastic, white
 Tischleuchte; Kunststoff, weiss
 luminaire de table; plastique, blanc

L 140, B 110, H 490, Base: B 130, T 105

LED 2,4W neutral WHITE 300lm LED 0,3W RGB 20lm



95695 CAJERO

table light; plastic, white
 Tischleuchte; Kunststoff, weiss
 luminaire de table; plastique, blanc

L 150, B 100, H 500, Base: B 155, T 100

LED 4,5W neutral WHITE 687lm



95696 CAJERO

table light; plastic, black
 Tischleuchte; Kunststoff, schwarz
 luminaire de table; plastique, noir

L 150, B 100, H 500, Base: B 155, T 100

LED 4,5W neutral WHITE 687lm





95696

LED



95694

LED

95694 CAJERO

table light; plastic, silver
Tischleuchte; Kunststoff, silber
luminaire de table; plastique, argent

L 150, B 100, H 500, Base: B 155, T 100

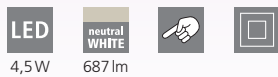

4,5W 687lm





DESIGN
HIGHLIGHT
DETAIL



99019

99019 TABILLANO 1

table light; steel, black
Tischleuchte; Stahl, schwarz
luminaire de table; acier, noir

L 560, B 180, H 475, Base: Ø 180



E27 1x 40W



9 002759 990190



96957 TORONA 1

table light; steel, white / wood, natural
Tischleuchte; Stahl, weiss / Holz, natur
luminaire de table; acier, blanc / bois, nature

L 445, B 180, H 605, Base: Ø 180



E14 1x 28W



9 002759 969578





96957



94699



94702

94699 BORGILLIO

table light; steel, white
Tischleuchte; Stahl, weiss
luminaire de table; acier, blanc

94702 BORGILLIO

table light; steel, chrome
Tischleuchte; Stahl, chrom
luminaire de table; acier, chrome

94697 BORGILLIO

table light; steel, black
Tischleuchte; Stahl, schwarz
luminaire de table; acier, noir

L 400, B 190, H 710, Base: Ø 190



E27 1x 40W



9 002759 946999

L 400, B 190, H 710, Base: Ø 190

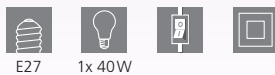

E27 1x 40W



9 002759 947026

L 400, B 190, H 710, Base: Ø 190

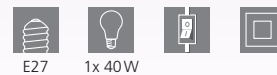

E27 1x 40W



9 002759 946975



94697



94704

94704 BORGILLIO

table light; steel, copper
Tischleuchte; Stahl, kupfer
luminaire de table; acier, cuivre

L 400, B 190, H 710, Base: Ø 190



E27



1x 40W



9 002759 947040

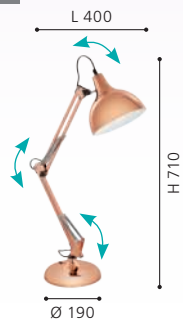



90967



90967 BANKER

table light; steel, brass / glass painted, green
Tischleuchte; Stahl, messing / Glas lackiert, grün
luminaire de table; acier, laiton / verre laqué, marron granit

L 275, H 390



E27



1x 60W



9 002759 909673



FIRMO

These luminaires come with a clip.

Diese Leuchten sind mit einer Klemme ausgestattet.

Ces luminaires viennent avec une pince fixation.



90872



90873



90874

90872 FIRMO

table light; steel, plastic, shiny white
Tischleuchte; Stahl, Kunststoff, weiss glänzend
luminaire de table; acier, plastique, blanc brillant

L 730



E27 1x 40W



9 002759 908720



90873 FIRMO

table light; steel, plastic, shiny black
Tischleuchte; Stahl, Kunststoff, schwarz glänzend
luminaire de table; acier, plastique, noir brillant

L 730



E27 1x 40W



9 002759 908737



90874 FIRMO

table light; steel, plastic, silver
Tischleuchte; Stahl, Kunststoff, silber
luminaire de table; acier, plastique, argent

L 730

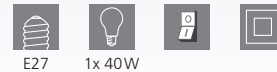

E27 1x 40W



9 002759 908744





90977



9228



9229

90977 BASIC 1

table light; plastic, steel, silver
Tischleuchte; Kunststoff, Stahl, silber
luminaire de table; plastique, acier, argent

H 300, Base: Ø 125



E27 1x 40W



9 002759 909772



9228 BASIC

table light; plastic, steel, black
Tischleuchte; Kunststoff, Stahl, schwarz
luminaire de table; plastique, acier, noir

H 300, Base: Ø 125



E27 1x 40W



9 002759 922801



9229 BASIC

table light; plastic, steel, white
Tischleuchte; Kunststoff, Stahl, weiss
luminaire de table; plastique, acier, blanc

H 300, Base: Ø 125



E27 1x 40W



9 002759 922900





9230

9232

9230 BASIC

table light; plastic, steel, red
 Tischleuchte; Kunststoff, Stahl, rot
 luminaire de table; plastique, acier, rouge

H 300, Base: Ø 125

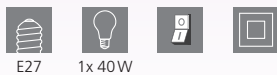

E27 1x 40W



9 002759 923006



9232 BASIC

table light; plastic, steel, blue
 Tischleuchte; Kunststoff, Stahl, blau
 luminaire de table; plastique, acier, bleu

H 300, Base: Ø 125

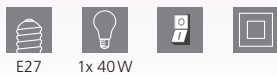

E27 1x 40W



9 002759 923204





DESIGN
HIGHLIGHT
DETAIL



92872

LED

92872 FOX

table light; steel, white, chrome
Tischleuchte; Stahl, weiss, chrom
luminaire de table; acier, blanc, chrome

H 320, Base: Ø 125



9 002759 928728



92873 FOX

table light; steel, anthracite, chrome
Tischleuchte; Stahl, anthrazit, chrom
luminaire de table; acier, gris anthracite, chrome

H 320, Base: Ø 125



9 002759 928735





92873

LED

CHILDREN LUMINAIRES

KINDERLEUCHTEN

LUMINAIRES POUR ENFANTS

PLAY OF COLOUR

The nursery luminaires are characterised by their playful and child-friendly designs. The lovely motives light up in many different colours and turn the nursery into a very special location.

FARBENSPIEL

Die Kinderzimmerleuchten zeichnen sich durch ihr verspieltes und kindgerechtes Design aus. Die liebevollen Motive erleuchten in unterschiedlichsten Farben und machen das Kinderzimmer zu einem besonderen Ort.

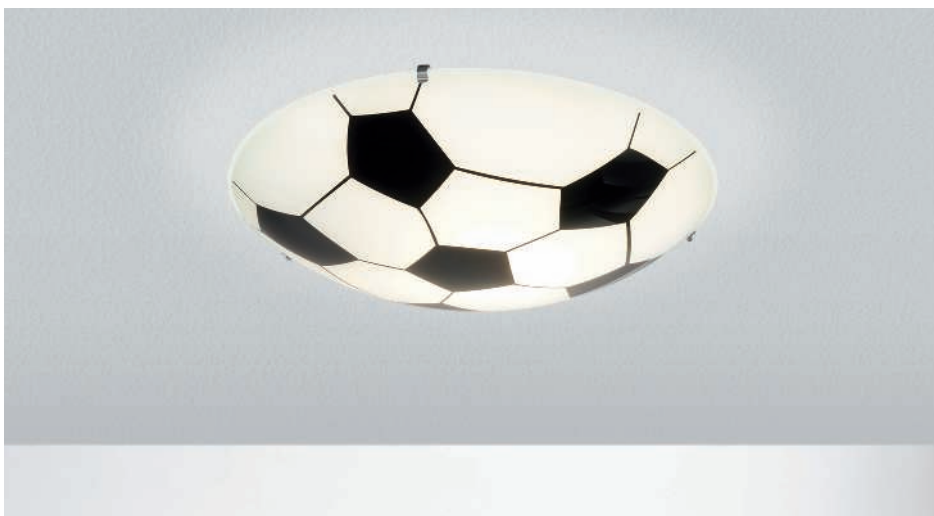

JEU DE COULEUR

Les éclairages de chambres d'enfants se distinguent de leur design joueur et adapté aux enfants. Les sujets formés avec amour sont illuminés dans des couleurs les plus variées et font de la chambre d'enfant un endroit spécial.





OVERVIEW

CHILDREN LUMINAIRES



TABARA
p. 836



JUNIOR 1
p. 836



RUFFO
p. 837

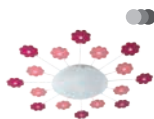

VIKI 1
p. 837



This product is available in different colors and shapes./ Dieser Artikel ist in unterschiedlichen Farben und Formen verfügbar.
Cet article est disponible en différentes couleurs et formes.



97667



87284

97667 TABARA

ceiling light; wood, steel, green, white / satin glass, design "soccer"

Deckenleuchte; Holz, Stahl, grün, weiss / Glas satiniert, Motiv Fussball

plafonnier; bois, acier, vert, blanc / verre satiné, motif «football»

H 80, Ø 400



E27



1x 60W

87284 JUNIOR 1

wall / ceiling light; steel, white / satin glass, design "soccer"

Wand- / Deckenleuchte; Stahl, weiss / Glas satiniert, Motiv Fussball

applique / plafonnier; acier, blanc / verre satiné, motif «football»

Ø 245



E27



1x 60W



9 002759 976675



Ø 400



9 002759 872847



Ø 245



97575



97575

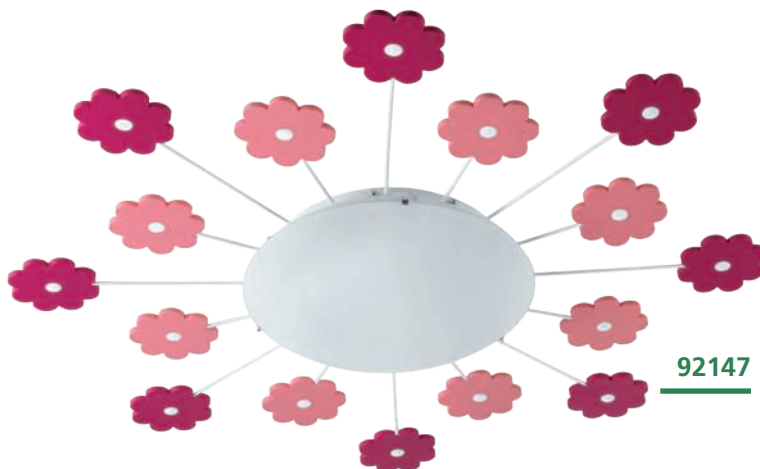

92147



92146

97575 RUFFO

ceiling light; steel, white / fabric, coloured
Deckenleuchte; Stahl, weiss / Textil, bunt
plafonnier; acier, blanc / tissu, coloré

H 110, Ø 380



E27 2x 40W



9 002759 975753

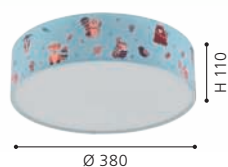

92146 VIKI 1

wall / ceiling light; steel, blue / satin glass, white
Wand- / Deckenleuchte; Stahl, blau / Glas satiniert, weiss
applique / plafonnier; acier, bleu / verre satiné, blanc

Ø 630, A 80



E27 1x 25W



9 002759 921460

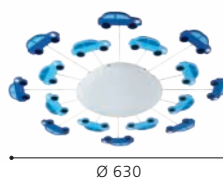

Ø 630

92147 VIKI 1

wall / ceiling light; steel, pink / satin glass, white
Wand- / Deckenleuchte; Stahl, pink / Glas satiniert, weiss
applique / plafonnier; acier, rose / verre satiné, blanc

Ø 615, A 80



E27 1x 25W



9 002759 921477

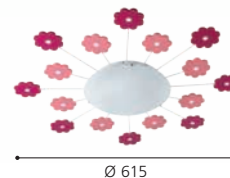

Ø 615

KITCHEN & FUNCTIONAL LUMINAIRES

KÜCHEN- & FUNKTIONSLEUCHTEN

LUMINAIRES FONCTIONNELS & DE CUISINE

YOUR KITCHEN FRIEND

Our kitchen and function luminaires ensure the right lighting for your workplace and become true supporters. The practical and perfect fitted luminaires ideally refine your kitchen area.

IHR KÜCHENFREUND

Unsere Küchen- und Funktionsleuchten sorgen für die richtige Beleuchtung Ihrer Arbeitsfläche und werden zur wahren Alltagshilfe. Die praktischen Unterbauleuchten sind die perfekte Ergänzung für Ihren Küchenbereich.



VOTRE AMI DE CUISINE

Nos lumières fonctionnelles et de cuisine assurent le bon éclairage de votre surface de travail et deviennent une aide parfaite dans le quotidien. Les éclairages de meuble sont l'accompagnement parfait de votre espace de cuisine.

OVERVIEW

KITCHEN & FUNCTIONAL LUMINAIRES



DUNDRY
p. 840-841



TEYA
p. 842



KOB LED
p. 843



BALIOLA
p. 843



This product is available in different colors and shapes./ Dieser Artikel ist in unterschiedlichen Farben und Formen verfügbar.
Cet article est disponible en différentes couleurs et formes.



97572



97573



97574



97572 DUNDRY

wall / ceiling light; plastic, white / plastic, white
Wand- / Deckenleuchte; Kunststoff, weiss / Kunststoff, weiss
applique / plafonnier; plastique, blanc / plastique, blanc

L 570, B 25, H 35



6,6W 850lm



9 002759 975722



97573 DUNDRY

wall / ceiling light; plastic, white / plastic, white
Wand- / Deckenleuchte; Kunststoff, weiss / Kunststoff, weiss
applique / plafonnier; plastique, blanc / plastique, blanc

L 870, B 25, H 35



9,3W 1250lm



9 002759 975739



97574 DUNDRY

wall / ceiling light; plastic, white / plastic, white
Wand- / Deckenleuchte; Kunststoff, weiss / Kunststoff, weiss
applique / plafonnier; plastique, blanc / plastique, blanc

L 1170, B 25, H 35



12,8W 1700lm



9 002759 975746

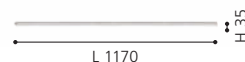



97571

LED

97571 DUNDRY

wall / ceiling light; plastic, white / plastic, white
Wand- / Deckenleuchte; Kunststoff, weiss / Kunststoff, weiss
applique / plafonnier; plastique, blanc / plastique, blanc

L 310, B 25, H 35

LED

3,7W

neutral
WHITE

450lm



9 002759 975715

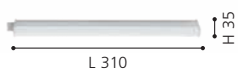



96081



TEYA

Mounting type: incl. mounting clips
Switch type: sensor switch (on/off)

Befestigungsart: inkl. Montageclips
Schalterart: Sensor Schalter (ein/aus)

Type de fixation : clips de montage inclus
Type de interrupteur : interrupteur capteur (on/off)

96081 TEYA

under cabinet light; aluminium, silver / plastic, white
Unterbauleuchte; Alu, silber / Kunststoff, weiss
éclairage de meuble; aluminium, argent / plastique, blanc

L 600, B 55, H 25

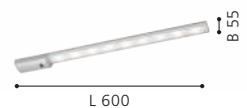



93707



93706

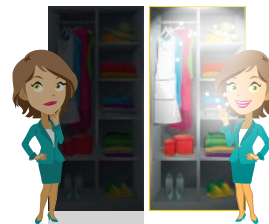

94686



3 m



94686

Incl. battery: yes
 Inkl. sensor: yes
 Switch type: on/off/auto
 Mounting type: incl. adhesive tape
 Moveable LED: no

Inkl. Batterie: ja
 Inkl. Sensor: ja
 Schalterart: ein/aus/auto
 Befestigungsart: inkl. Klebeband
 Bewegliche LED: nein

Piles incluses : oui
 Capteur inclus : oui
 Type de interrupteur : marche/arrêt/auto
 Type de fixation : ruban adhésif inclus
 LED réglable : non

93707 KOB LED

under cabinet light; steel, satin nickel
 Unterbauleuchte; Stahl, nickel-matt
 éclairage de meuble; acier, nickel mat

L 600, B 70, H 25



3x 2,3W 780lm

93706 KOB LED

under cabinet light; steel, white
 Unterbauleuchte; Stahl, weiss
 éclairage de meuble; acier, blanc

L 600, B 70, H 25



3x 2,3W 780lm

94686 BALIOLA

wall light; plastic, silver
 Wandleuchte; Kunststoff, silber
 applique; plastique, argent

L 180, H 46, A 27

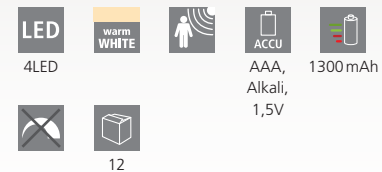

AAA, 1300mAh, 1,5V



9 002759 937072

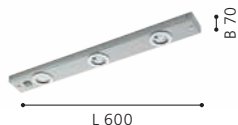

9 002759 937065



9 002759 946869

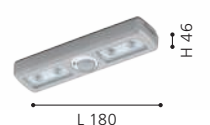

ACCESSORIES

ZUBEHÖR
ACCESSOIRES

MAKING IT SPECIAL

Supplement your personal luminaire range with practical accessories and make your everyday life easier.

DAS GEWISSE EXTRA

Ergänzen Sie Ihr persönliches Leuchten-sortiment mit praktischem Zubehör und erleichtern Sie sich somit Ihren Alltag.



LE PETIT PLUS QUI COMPTE

Accompagnez votre collection personnelle de lumières par des accessoires pratiques et facilitez-vous ainsi votre quotidien.



92288

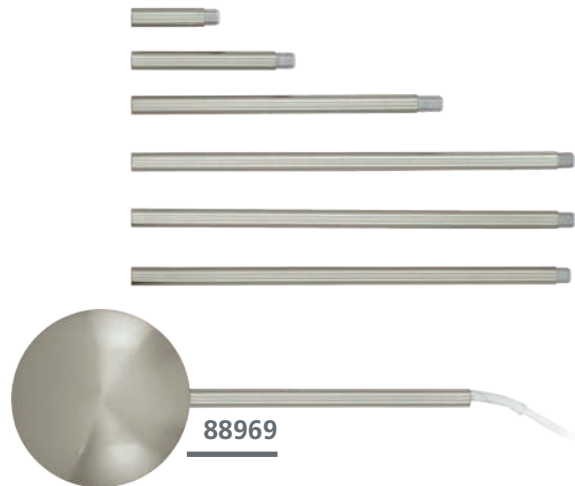

88969

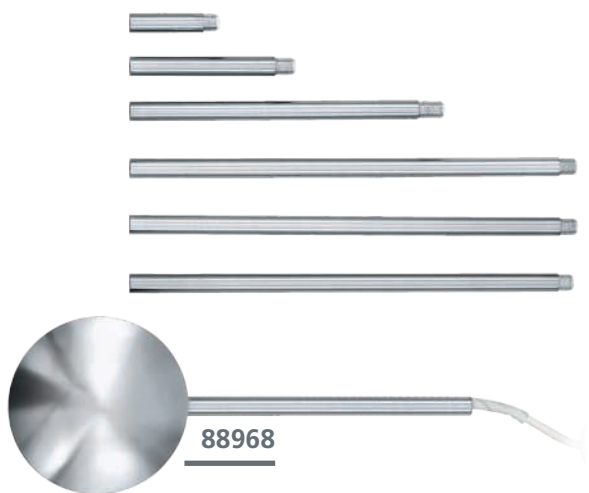

88968



88968, 88969, 92288

Can be extended or shortened from 320 to 1570 mm by screwing in/off the single pieces.

Der Kabelkanal kann durch Ein-/Ausdrehen der Einzelstücke von 320 bis 1570 mm verlängert bzw. verkürzt werden.

Le conduit de câble peut être prolongé ou raccourci en visse/dévisse les pièces uniques de 320 à 1570 mm.

92288 EXTENTION

accessory; steel, white
Zubehör; Stahl, weiss
accessoire; acier, blanc

L 1570, B 120

88969 EXTENTION

accessory; steel, satin nickel
Zubehör; Stahl, nickel-matt
accessoire; acier, nickel mat

L 1570, B 120

88968 EXTENTION

accessory; steel, chrome
Zubehör; Stahl, chrom
accessoire; acier, chrome

L 1570, B 120

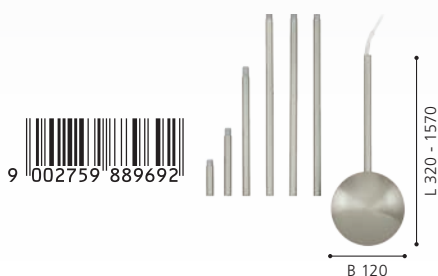



+



=



RUEDA

Turns your single-light luminaire into a three-light one for brighter lighting!

Verwandelt Ihre einflammige Leuchte in eine dreiflammige Lichtquelle für hellere Beleuchtung!

Il transforme votre luminaire à une lumière en une source lumineuse à trois lumières pour un éclairage plus clair!



92348



98277



98279

92348

accessory; plastic, white
Zubehör; Kunststoff, weiss
accessoire; plastique, blanc

L 113, B 44, H 28



10



98277 RUEDA

accessory; plastic, white
Zubehör; Kunststoff, weiss
accessoire; plastique, blanc

H 75, Ø 190



E27

3x 20W

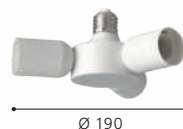

98279 RUEDA

accessory; plastic, black
Zubehör; Kunststoff, schwarz
accessoire; plastique, noir

H 75, Ø 190



E27

3x 20W





1



2



3

GLASS ASSORTMENT

GLAS SORTIMENT
SORTIMENT DE VERRES

SPECIAL GLASS

on this page we would like to give you a detailed view on an assortment of glasses that are used with our luminaires.

SPEZIAL GLAS

Auf diesen Seiten möchten wir Ihnen einen detaillierten Blick auf ausgesuchte Gläser geben, welche wir für unsere Produkte verwenden.



VERRES SPECIAL

Sur cette page nous voulons vous donner un aperçu détaillé des verres choisis que nous utilisons pour notre produits.



GLASS MATERIALS

GLAS-MATERIALIEN
MATÉRIAUX DE VERRE



glass alabaster, white
Glas alabaster, weiß
verre albâtre, blanc

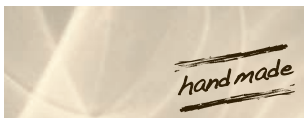

glass alabaster, champagne
Glas alabaster, champagner
verre albâtre, champagne

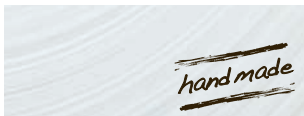

coating, black
Beschichtung, schwarz
revêtement, noir



glass wipe technique, champagner
Glas Wischtechnik, champagner
verre technique à l'essuyés, champagner



limed glass
Glas gekalkt
verre chaulé



crystal
Kristall
cristal

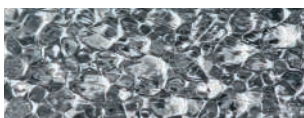

structured glass
Glas mit Struktur
verre structuré blanc



molten splinters of glass/crystal (granille)
geschmolzene Splitter von Glas / Kristall
(granille)
éclats fondus de verre / cristal (granille)

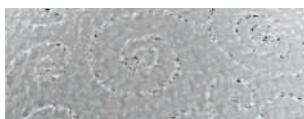

structured glass, white printed decor
strukturiertes Glas, weiß gedrucktes Dekor
verre structuré, décor imprimé blanc



printed glass with decor
bedrucktes Glas mit Dekor
verre imprimé avec la décoration



glass painted, green
Glas lackiert, grün
verre laqué, vert



smoked glass, black-transparent
Rauchglas, schwarz-transparent
verre fumé, noir transparent



glass vaporized, black-transparent
Glas bedampft, schwarz-transparent
verre vaporisé, noir transparent



glass vaporized, amber
Glas bedampft, amber
verre vaporisé, ambre



gold-color
goldfarben
or



black-brown-transparent
schwarz-braun-transparent
noir-marron-transparent



black-grey-transparent
schwarz-grau-transparent
noir-gris-transparent

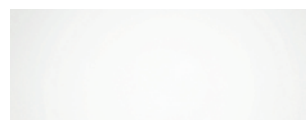

glass opal-matt
glas opal-matt
vere opale-mat

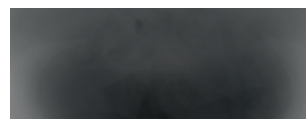

grey-matt
grau-matt
gris mat

EGLO WORLDWIDE

EGLO WELTWEIT

EGLO DANS LE MONDE



AUSTRIA

EGLO LEUCHTEN GMBH

Heiligkreuz 22
6136 Pill
T: +43 5242 6996 0 | F: +43 5242 6996 972
info-austria@eglo.com



AUSTRALIA

EGLO LIGHTING AUSTRALIA

5/339 Archerfield Road
4077 Richlands | Queensland
T: +61 7 3375 1413 | F: +61 7 3375 1412
info@eglolighting.com.au



BELGIUM

EGLO BELGIUM BV

Antwerpsesteenweg 247
2950 Kapellen
T: +32 3 250 60 80 | F: +32 3 219 80 67
info-belgium@eglo.com



BOSNIA AND HERZEGOVINA

EGLO RASVJETA BH D.O.O.

Ormanica bb
76250 Gradacac
T: +387 35 86 85 00 | F: +387 35 82 44 41
info-Bosnia-Herzegovina@eglo.com



BULGARIA

EGLO BULGARIA EOOD

Main Road Burgas-Sofia | 5th kilometer | Building EGLO
8000 Burgas
T: +359 56 960 403 | F: +359 56 53 05 95
info-bulgaria@eglo.com



CANADA

EGLO CANADA INC.

20700 Route Transcanadienne
H9X 4B7 Baie D'Ufré, Quebec
T: +1 514 457 5483 | F: +1 514 457 5487
info-canada@eglo.com



CHILE

EGLO CHILE ILUMINACIÓN LTDA.

Av. Américo Vespucio Norte 1930
Conchali - Santiago de Chile
T: +562 2 595 2222
info-chile@eglo.com



CHINA

DONGGUAN EGLO LIGHTING COMMERCIAL
CO LTD

No.1 | Shangqiao Industrial Rd Shangqiao, Dongcheng
Dongguancity, Guanzhouprovince
T: +86 769 2203 3866 | F: +86 769 2203 6866
info-china@eglo.com



COLOMBIA

EGLO COLOMBIA ILUMINACIÓN SAS

Autopista Norte 800 Mts adelante del Peaje de los Andes
Costado Oriental Km 19 Lote 30
Bogotá - Chia
T: +57 (1) 744 2339
info-global@eglo.com



COSTA RICA

EGLO COSTA RICA

Centro Comercial Calle Real local #8
Guachipilin de Escazú de la sucursal del BAC
San Jose 800 metros al norte | San Jose
T: +506-2289-4690 | F: +506-2100-6384
info-costarica@eglo.com



CROATIA

EGLO RASVJETA D.O.O.

Jadranska avenija 9a
10000 Zagreb
T: +385 1 379 40 62 | F: +385 1 379 41 04
info-croatia@eglo.com



CZECH REPUBLIC

EGLO CZ+SK s.r.o.

Náchodská 2479/63
193 00 Praha 9 Horní Pocernice
T: +420 281 924 163 | F: +420 281 925 205
info-czechrepublic@eglo.com



DENMARK

EGLO DANMARK A/S

Agerbakken 20
8362 Hørning
T: +45 70 22 55 11 | F: +45 70 22 55 221
info-denmark@eglo.com



ESTONIA

MOODNE VALGUSTUS AS

Rävalapst. 7
10143 Tallinn
T: +372 667 6670 | F: +372 631 3195
info-global@eglo.com



FINLAND

EGLO FINLAND OY

Malmniraitti 17A
700 Helsinki
T: +358 20 7649 820 | F: +358 20 7649 821
info-finland@eglo.com



FRANCE

EGLO FRANCE LUMINAIRE SARL

Z.A. Jeune Bois | 2 Rue de la Martinique
68274 Wittenheim
T: +33 3 89 62 50 45 | F: +33 389 6250 49
info-france@eglo.com



GERMANY

EGLO LEUCHTEN HANDELS GMBH

Kleinbahnstr. 35
59759 Arnsberg
T: +49 2932 6269 0 | F: +49 2932 6269 39
info-germany@eglo.com



GREAT BRITAIN AND IRELAND

EGLO UK LTD.

Unit 12 Cirrus Park, Lower Farm Road, Moulton Park
Industrial Estate, Northampton NN3 6UR
T: +44 1604 790 986 | F: +44 1604 670 282
info-greatbritain@eglo.com

**GREECE**
EGLO HELLAS A.E.

Sykias 2 and parodos dekeleias
13679 Acharnai
T: +30 21 0800 2363 | F: +30 210 240 07 29
info-greece@eglo.com

**HUNGARY - PRODUCTION AND LOGISTICS**
EGLO MAGYARORSZAG KFT.

Fő út, 155
3060 Paszto
T: +36 32 560 050 | F: +36 32 560 040
info-hungary@eglo.com

**INDIA**
EGLO INDIA PRIVATE LIMITED

A-307, Ansal Chambers - 1, 3, Bhikaji Cama Place,
110066 Delhi
T: +91 85279 44288
info-india@eglo.com

**ITALY**
EGLO ITALIANA S.R.L.

Via Giotto, 4
31021 Mogliano Veneto (TV)
T: +39 041 45 66 232 / -245/ -251 |
F: +39 041 45 74 066 / -071
info-italy@eglo.com

**KAZAKHSTAN**
EGLO KAZAKHSTAN LLP

Al-Farabi Avenue 7, Office 72, 14rd floor, Block 4A,
Nurly-Tau Business Center
50059 Almaty
T: +7 727 293 25 20 | M: +7 701 031 00 00
info-kazakhstan@eglo.com

**KOSOVO**
EGLO KOSOVA LLC

Lugisht e qytetit pn
20000 Prizren
T: +383 44 216 687 | SHOP: +383 49 699 100
info-kosovo@eglo.com

**LATVIA**
MOODNE VALGUSTUS AS

Rävalapst.7
10143 Tallinn
T: +370 652 49923 | T: +372 667 6670
info-latvia@eglo.com

**LITHUANIA**
MOODNE VALGUSTUS AS

Rävalapst.7
10143 Tallinn
T: +370 652 49923 | T: +372 667 6671
info-latvia@eglo.com

**MAGYARORSZÁG – ÉRTÉKESÍTÉS**
EGLO LUX KFT.

Fő út, 143/A
2120 Dunakeszi
T: +36 27 341 353 | F: +36 27 341 409
info-hungary@eglo.com

**MALAYSIA**
EGLO ASIA SDN BHD

No. 13, Jalan Pelukis U1/46B, Temasya 18, Glenmarie,
40150 Shah Alam, Selangor Darul Ehsan
T: +6011 1050 2336 | F: +603 5567 9415
info-malaysia@eglo.com

**MEXICO**
EGLO MÉXICO ILUMINACIÓN S DE RL DE CV

Prolongación Avenida López Mateos Sur N°3561,
Fraccionamiento Los Gavilanes
C.P. 45645 Tlajomulco de Zúñiga | Jalisco
T: +52 33 3687 20 95
info-mexico@eglo.com

**MIDDLE EAST**
EGLO LIGHTING MIDDLE EAST FZE

P.O. BOX 262073, LOB6, OFFICE G18
Jebel Ali, Dubai, UAE
T: +97 148810080 | F: +97 148810081
gulf@eglo.com

**MOROCCO - EGLO AFRICA**
EGLO MAGHREB LUMINAIRES SARL

219 Bd Med Zerktonni. Suite: 67
20330 Casablanca
T: +212 522 98 80 25 / -05
info-global@eglo.com | info.africa@eglo.com

**THE NETHERLANDS**
EGLO VERLICHTING NEDERLAND B.V.

Innovatiepark 20
4906 AA Oosterhout (NBR)
T: +31 162 48 28 30
info.netherlands@eglo.com

**NORWAY**
MS Belysning AS

Heiaveien 4
1900 Fetsund
T: +47 63 888500 | F: +47 63 888501
info-norway@eglo.com

**PERU**
EGLO PERU S.A.C

Av Primavera 1419
Distrito de Santiago de Surco y Departamento de Lima
T: +51 902 763 635
info-peru@eglo.com

**POLAND**
EGLO POLSKA SP. Z O.O.

Ul. Dźwiękowa 2
02-857 Warszawa
T: +48 22 644 57 55 | F: +48 22 644 89 82
info-poland@eglo.com

**PORTUGAL**
EGLO PORTUGAL ILUMINAÇÃO, LDA

Rua Fonte Parada, 125
4595-434 Serroa-Paços de Ferreira
T: +351 255 890 000 | F: +351 255 892 346
info-portugal@eglo.com

**ROMANIA**
EGLO ROMANIA PRODEXIM SRL.

Str. Atomistilor nr. 1D
77125 Magurele - Ilfov
T: +40 314 250 902 | F: +40 314 250 899
info-romania@eglo.com

**RUSSIA**
EGLO LIGHTING LLC

Varshavskoe shosse 3 | Office 23
117105 Moscow
T: +7495 789 4311 | F: +7495 789 4312
info-russia@eglo.com

**SERBIA**
EGLO RASVETA DOO

Stefana Prvovenčanog 28
11000 Beograd
T: +381 11 3981 366 | F: +381 11 3981 389
info-serbia@eglo.com

**SLOVAKIA**
EGLO CZ+SK s.r.o

Náchodská 2479/63
193 00 Praha 9 Horní Pocernice
T: +421 313 211 551 | F: +421 313 211 556
info-slovakia@eglo.com

**SLOVENIA**
EGLO RASVJETA D.O.O.

Jadranska avenija 9a
10000 Zagreb
T: +386 158 093 18
info-slovenia@eglo.com

**SPAIN**
EGLO ESPANA ILUMINACION S.L.

Avda. de Castilla 1 (Edf. Best Point) 2º -16A
28830 San Fernando de Henares, Madrid
T: +34 91 677 9044 | F: +34 91 677 0304
info-spain@eglo.com

**SWEDEN**
EGLO SVERIGE AB

Star Street 1
512 50 Svenljunga
T: +46 340 623 505 | F: +46 340 623 605
info-sweden@eglo.com

**SWITZERLAND**
EGLO SCHWEIZ AG

Seetalstraße 142
6032 Emmen
T: +41 41 268 69 59 | F: +41 41 268 69 58
info-switzerland@eglo.com

**TURKEY**
EGLO Aydınlatma ithalat ihracat Ltd. Şti.

Eyüp Sultan Mah. Sekmen Cad. No:18/2
34855 Sancaktepe / Istanbul Samandıra
T: +90 216 311 09 -02 / -03 / -04 |
F: +90 216 311 09 / -05
info-turkey@eglo.com

**UKRAINE**
EGLO UKRAINE LTD

Vatslava Gavela boulevard, 6/7-A,
03124 Kyiv
T: +38 044 463 98 41 | F: +38 044 468 84 67
info-ukraina@eglo.com

**USA**
EGLO USA, INC.

3640 Royal South Parkway
30349 Atlanta, Georgia
T: +1 404 477 5601 | F: +1 404 393 7053
info-usa@eglo.com

HOW TO READ

ERKLÄRUNG

COMMENT LIRE

BUTTONS
BUTTONS
BOUTONS

Forest Stewardship Council®



p.8-9

DIMENSIONS DIMENSIONEN DIMENSIONS

all dimensions in mm | alle Größen in mm | toutes dimensions en mm

L = length | Länge | longueur

B = width | Breite | largeur

H = height | Höhe | hauteur

Ø = diameter | Durchmesser | diamètre

A = projection length | Ausladung | amplitude

ET = installation depth | Einbautiefe | profondeur utile

Base = base dimensions | Sockelmaße | dimensions de base

Attention! The dimensions relate solely to the sizes of the luminaire.
Any air spaces that would be relevant for a safe operating of the lamp were not considered.

Achtung! Die Größen beziehen sich nur auf die Abmessungen der Leuchte. Etwaige Lufträume, die für einen sicheren Betrieb der Leuchte notwendig sind, werden nicht berücksichtigt.

Attention! Les dimensions se réfèrent à la taille de la lampe seulement. Espacements éventuels, que seraient importants pour une opération de la lampe sans danger, n'ont pas été considérés.

BUTTONS BUTTONS BOUTONS

Colour Rendering Index | Farbwiedergabeindex | Indice de rendu de couleur de LED

CRI
>90

p.557

Bulb included | Leuchtmittel inkludiert | ampoules inclus



Recessed Luminaire | Einbauleuchte | luminaire encastrable



Surface Luminaire | Aufbauleuchte | luminaire en saillie



SKETCHES SKIZZEN CROQUIS

The sketches state the most meaningful dimensions. If a product is adjustable by will, a turquoise arrow marks this function and only the maximum dimensions are indicated.

Die Bemaßung der Skizzen umfasst jeweils die aussagekräftigsten Größen. Bei verstellbaren Produkten kennzeichnet ein türkiser Pfeil diese Funktion und nur die maximalen Größen werden angegeben.

Les dimensions des croquis comprennent les plus représentatives. Si un produit est réglable au choix, une flèche turquoise affiche cette fonction et rien que les dimensions maximales sont indiquées.

99551 CASIBARE
pendant light; steel, black
Hängeleuchte; Stahl, schwarz
luminaire en suspension; acier, noir

H 1100, Ø 150

E27 1x 40W

9 002759 995515

Ø 150

99552 CASIBARE
pendant light; steel, black
Hängeleuchte; Stahl, schwarz
luminaire en suspension; acier, noir

L 850, B 150, H 1100

E27 3x 40W

9 002759 995522

L 850

99553 CASIBARE
pendant light; steel, black
Hängeleuchte; Stahl, schwarz
luminaire en suspension; acier, noir

H 1500, Ø 710

E27 5x 40W

9 002759 995539

Ø 710

LIGHTING FAMILIES / STANDARD
234

ARTICLE NUMBER
ARTIKELNUMMER
NUMÉRO D'ARTICLE

SERIES NAME
SERIENNAME
NOM DE LA SÉRIE

DESCRIPTION
BESCHREIBUNG
DESCRIPTION

The product description is composed as follows:
luminaire type; enclosure material, enclosure colour / glass or shade material, glass or shade colour
Die Produktbeschreibung setzt sich wie folgt zusammen:
Leuchtenart; Gehäusematerial, Gehäusefarbe / Schirm- bzw. Glasmaterial, Schirm- bzw. Glasfarbe
La description du produit est composée comme suit:
type de luminaire; matériel de boîtier, couleur de boîtier / matériel de verre ou abat-jour, couleur de verre ou abat-jour



99554



99555

99554 CASIBARE
table light; steel, black
Tischleuchte; Stahl, schwarz
luminaire de table; acier, noir

L 160, B 120, H 490, Base: Ø 155



E27 1x 28W



9 002759 995546



L 160
H 490
Ø 155

99555 CASIBARE
floor light; steel, black
Stehleuchte; Stahl, schwarz
lampadaire; acier, noir

L 350, B 120, H 1605, Base: Ø 250



E27 2x 28W



9 002759 995553



L 350
H 1605
Ø 250

LIGHTING FAMILIES / STANDARD
235

PRODUCT / PRODUCT IN THE AMBIANCE
PRODUKT / PRODUKTE IM AMBIENTE
PRODUITS / PRODUITS DANS L'AMBIANCE

You can find the article number next to each product on the page and in the ambiance pictures.
Sie finden die Artikelnummer jedes Produktes neben der Abbildung auf der Seite und auf unseren Ambientebildern.
Vous pouvez trouver le numéro d'article à la page et à côté de chaque produit dans les images de l'ambiance.

PICTOGRAMMES
PIKTOGRAMME
PICTOGRAMMES

Technical details are represented as pictograms. An overview over all pictograms can be found on the next pages.
Technische Details werden als Piktogramme dargestellt. Eine Übersicht über alle Piktogramme finden Sie auf den nächsten Seiten.
Les détails techniques sont représentés sous forme de pictogrammes. Vous trouverez un aperçu de tous les pictogrammes dans les pages suivantes.

ENERGY EFFICIENCY LABELS
ENERGIEEFFIZIENZ-LABEL
LABEL DE L'EFFICACITÉ ÉNERGÉTIQUE

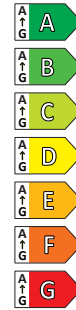
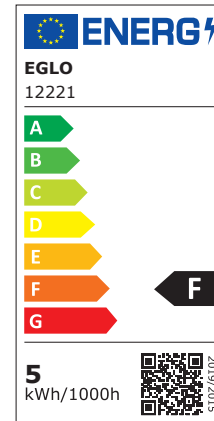

The new energy label must be indicated on all light sources with a luminous flux between 60 and 82,000 lumens and OLED. This applies to lamps, LED modules and luminaires where the light source cannot be removed without destroying it.

Das neue Energielabel muss auf allen Lichtquellen mit einem Lichtstrom zwischen 60 und 82.000 Lumen und OLED angegeben werden. Dies gilt für Lampen, LED-Module und Leuchten, bei denen die Lichtquelle nicht zerstörungsfrei entnommen werden kann.

Le nouveau label énergétique doit être indiqué sur toutes les sources lumineuses dont le flux lumineux est compris entre 60 et 82 000 lumens et sur les OLED. Cela s'applique aux lampes, aux modules LED et aux luminaires dont la source lumineuse ne peut être retirée sans être détruite.



















The information on the label includes: / Die Angaben auf dem Etikett beinhalten: / Les informations figurant sur l'étiquette sont les suivantes :

- › Name/Trademark
Name/Warenzeichen
Nom/marque de commerce
- › Model / Modell / Modèle
- › Energy label scale A-G / Energielabel-Skala A-G / Échelle d'étiquetage énergétique A-G
- › Energy consumption for 1,000 hours of use / Energieverbrauch bei 1.000 Stunden Nutzung / Consommation d'énergie pour 1 000 heures d'utilisation
- › Energy efficiency class of the product / Energieeffizienzklasse des Produkts / Classe d'efficacité énergétique du produit
- › QR Code to EPREL (Product Database of the European Product Registry for Energylabelling) / QR Code zur EPREL (Produkt Datenbank der European Product Registry for Energylabelling) / Code QR pour EPREL (base de données des produits du registre européen des produits pour l'étiquetage énergétique)
- › The energy spectrum ranges from G to A. Das Energiespektrum reicht von G bis A. Le spectre énergétique va de G à A.























































PICTOGRAM

PIKTOGRAMME PICTOGRAMME

SOCKETS / FASSUNGEN / DOUILLES

 LED	 G4	 G53
 2G7	 G5	 GU5,3 / MR16
 2G11	 G9	 GU10
 2GX13	 G10Q	 GX53
 E14	 G13	 GY6,35
 E27	 G23	 R7s

BULBS / LEUCHTMITTEL / AMPOULES

 E14 / C35	 E27 / A60 Halogen	 E27 / E140 Filament
 E14 / C35f	 E27 / R63 Halogen	 E27 / PS160 Filament
 E14 / D45	 E27 / A60 LED	 E27 / T30 Filament
 E14 / C35f LED	 E27 / A60 Filament	 E27 / T32 Filament
 E14 / D45 Halogen	 E27 / A65 LED	 G4 / T9
 E14 / C35 Halogen	 E27 / A75 Filament	 G4 / LT9
 E14 / T22	 E27 / G45 LED	 G4 / LT14
 E14 / C35 Filament	 E27 / G45 Filament	 G9
 E14 / C37 Filament	 E27 / G80 Filament	 G9 LED
 E14 / C35f Filament	 E27 / G95	 GU10
 E14 / C37f Filament	 E27 / G95 Filament	 GU10 LED
 E14 / P45 LED	 E27 / G125	 GU10 SMD LED
 E14 / P45 Filament	 E27 / G95 LED	 GX53 / LF75
 E14 / P50	 E27 / G200 Filament	LED LED board / LED Platine / LED bord
 E14 / ST48 Filament	 E27 / R63 LED	 MR16
 E14 / ST64 Filament	 E27 / ST48 Filament	 MR16 LED
 E14 / T20 LED	 E27 / ST64 Filament	 R7s / 78mm
 E27 / A60	 E27 / B80 Filament	 R7s / 118mm
 E27 / G90	 E27 / BR150 Filament	 R7s / 78mm LED
 E27 / QR63	 E27 / DP165 Filament	 R7s / 118mm LED

LIGHT COLOUR & LUMEN / LICHTFARBE & LUMEN / COULEUR LUMINEUX & LUMEN

The colours of the LED are represented as pictogrammes (see below), their luminous flux directly beneath. The luminous flux is quoted in lumen and describes the amount of light generated by the LED. The higher the value, the brighter is the lamp. Lumens are LED boards and are the light measurement value in bulbs.

Die Farben der LED werden als Piktogramm (siehe unten) dargestellt, deren Lichtstrom direkt darunter. Der Lichtstrom wird in Lumen gemessen und gibt die erzeugte Lichtmenge der LED an. Je höher der Wert, desto heller das Produkt. Lichtstromangaben (Lumen) sind Platinen- bzw. Leuchtmittelwerte.

Les couleurs de LED ont représentés sous forme de pictogrammes, leur flux lumineux directement en dessous. L'unité de flux lumineux est le lumen et il mesure la quantité de lumière générée par les LED. Plus la valeur est élevée, plus la lampe est lumineuse. Les lumens sont l'unité de mesure de l'intensité lumineuse des ampoules et des panneaux led intégrés.

	RGB RGB RGB
	RGB + white RGB + weiß RGB + blanc
	RGB + warmwhite RGB + warmweiß RGB + blanc chaud
	RGB + coldwhite RGB + kaltweiß RGB + blanc froid

	RGB + neutralwhite RGB + neutralweiß RGB + blanc neutral
	RGB + tunable white RGB + tunable white RGB + tunable white
	tunable white tunable white tunable white
	warm white warmweiß blanc chaud

	cold white kaltweiß blanc froid
	neutral white neutralweiß blanc neutre

SWITCHES & SENSORES / SCHALTER & SENSOREN / INTERRUPTEUR & CAPTEURS

	incl. cable & plug inkl. Kabel & Stecker câble & connecteur inclus
	internal dimmer eingebauter Dimmer variateur intégré
	button switch Druckknopf interrupteur de pression
	function switch Funktionsschalter interrupteur fonction
	rocker switch Wippschalter interrupteur à bascule
	pedal dimmer Trittdimmer variateur à pied

	pedal switch Trittschalter interrupteur à pied
	cable switch Kabelschalter interrupteur à câble
	incl. cable & plug transformer inkl. Kabel & Stecktransformator câble & transformateur à prise
	remote control Fernbedienung télécommande
	Day & Night Sensor Tag & Nacht Sensor sensor jour & nuit
	sensor Sensor sensor

	swedish plug Stecker Schweden connecteur swede
	"Touch me" ON/OFF "Touch me" EIN/AUS "Touch me" ON/OFF
	"Touch me" ON/OFF & dimm "Touch me" EIN/AUS & Dimmen "Touch me" ON/OFF & graduable
	pull switch Zugschalter interrupteur à bascule
	Timer - automatic on/off Zeitschaltuhr - automatisches Ein- & Ausschalten minuterie - peut être éteint et allumé automatiquement

FUNKTIONS & COMFORT / FUNKTIONEN & KOMFORT / FONCTIONS & CONFORT

	incl. battery inkl. Akku incl. pile
	incl. battery inkl. Batterie incl. pile
	battery specifications Batteriespezifikationen spécifications des piles
	beam angle Ausstrahlwinkel angle de rayonnement
	corner mount possible Eckmontage möglich montage en coin possible
	Colour Rendering Index

	cutout (in mm) Ausschnitt (in mm) perçage du panneau (en mm)
	dimmmable with external dimmer dimmmbar mit externen Dimmer graduable avec un gradateur externe
	not dimmmable nicht dimmmbar ne pas graduable
	Can be operated via control unit Bedienbar über Steuergerät Peut être commandé par une unité de contrôle
	replaceable LED austauschbare LED LED remplaçables
	loadable in kg belastbar in kg chargeable en kg

	packaging / delivery unit Verpackungs- / Liefereinheit unité d'emballage / de livraison
	shortable kürzbar réductible
	Voltage Volt Voltage
	Watt
	USB connection USB-Anschluss Connexion USB
	Qi-Charger

PROTECTION CLASS / SCHUTZKLASSE / CLASSE DE PROTECTION

The protection class indicates to what extent the lamp is protected against electric shock. All lamps in this catalogue are at least protected with the protection class 1 - a higher class is specified in the information box of the respective lamp.

Die Schutzklasse gibt an, inwiefern ein Produkt gegen einen elektrischen Schlag gesichert ist. Alle Leuchten in diesem Katalog sind mit mindestens Schutzklasse 1 gesichert, bei höheren Klassen wird das Symbol im Infokasten der Leuchte angegeben.

La classe de protection indique, dans quelle mesure la lampe est protégée contre les chocs électriques. Tous les lampes dans ce catalogue sont protégées au moins avec la classe 1 - une classe plus élevée est indiquée dans l'information de la lampe.

	protection class 1: protective earthing Schutzklasse 1: Schutzerdung classe de protection 1: prise de terre
--	---

	protection class 2: protective insulation Schutzklasse 2: Schutzisolierung classe de protection 2: double isolation ou renforcée
--	--

	protection class 3: protective low voltage Schutzklasse 3: Schutzkleinspannung classe de protection 3: très basse tension de sécurité
--	---

PROTECTION RATING / SCHUTZGRAD / INDICE DE PROTECTION

The protection rating ensures the operational safety of luminaires. The first number specifies the extent of the protection against the ingress of foreign bodies; the second number identifies the humidity protection grade. All luminaires in this catalogue are at least protected with the rating IP20 - a higher rating is specified in the information box of the luminaire.

Der Schutzgrad gewährleistet die Betriebssicherheit von Leuchten. Die erste Ziffer des IP Grades beschreibt den Schutzzumfang gegen das Eindringen von Fremdkörpern; die zweite Ziffer informiert über den Grad des Feuchtigkeitsschutzes. Alle Leuchten in diesem Katalog sind mit mindestens Schutzgrad IP20 gesichert, bei höheren Graden wird das Symbol im Infokasten der Leuchte angegeben.

L'indice de protection assure la sécurité opérationnelle des luminaires. Le premier chiffre indique à quel point la protection est efficace contre l'insertion de corps étrangers; le second chiffre indique quant à lui le degré de protection par rapport à l'humidité. Tous les luminaires dans ce catalogue sont protégés au moins avec l'indice IP20 - un indice plus élevé est indiqué dans l'information d'article.

	IP33		IP44
--	------	--	------

	IP54		IP65
--	------	--	------

	IP67
--	------

REGISTER

SERIES NAMES
SERIENNAMEN
NOME DE PRODUITS

NAME NAME NOM	PAGE SEITE PAGE	NAME NAME NOM	PAGE SEITE PAGE	NAME NAME NOM	PAGE SEITE PAGE
ABREOSA	232	ARENAZA	803	BELSIANA	476
ACCESS REMOTE	102	ARISCANI	342-343	BELSIANA 1	477
ACOLLA	497	BAJAZZARA	198-199	BENARIBA	525
ACOLLA 1	497	BALIOLA	843	BERREGAS	674
AGLIENTINA	189	BANDERALO	804	BILBANA	790
AGUILARES	332	BANDERILLAS	294-295	BIMEDA	710-713
ALAMEDILLA	294	BANKER	826	BITACHITO	383
ALBANY	445	BARBOTTO	768	BOCADELLA	378
ALBARACCIN	352-353	BARI 1	651	BOCADELLA 1	474
ALBARIZA	184	BARI-M	610	BOLIVIA	414
ALCUDIA	633	BARNHAM	706-707	BOLSANO	362
ALEANDRO 1	360	BARRANCAS	478	BORDONARA	472
ALESSANDRA	445	BASIC	828-829	BORGILLIO	769,824-825
ALMEIDA	191	BASIC 1	828	BOYAL	224-227
ALMEIDA 1	190	BASILANO	322-323	BRENDA	440-442
ALMEIDA 2	186-187	BASILANO 1	320-321	BROLINI	809
ALMERA	561	BASURTU	490	BUCAMARANGA	164
ALMONTE	604	BATABANO	787	BUDENSEA	766
ALOBRASE	335-337,339	BATALLAS	664-665	BUENAVISTA	652
ALTAFLOR	456-458	BATISTA	335	BUENAVISTA 1	654
ALVEZ	447	BATISTA 3	361,785	BUENAVISTA 2	654-655
AMADORA	278	BATTISTONA	524	BUTRANO	399
AMEZAGA	788	BAYA	774	BUZZ-LED	734-739
AMEZOLA	600	BAYA LED	772-773	CABADO	752
AMONTILLADO	394,464	BAYMAN	279	CABADO 1	820
ANCHORENA-Z	22-23	BELESER	346,766	CABALES	818-819
ANDABAIA-Z	27	BELLARIVA	782	CABO	494
ARANZOLA	765	BELLARIVA 3	783	CABO 1	742

NAME NAME NOM	PAGE SEITE PAGE	NAME NAME NOM	PAGE SEITE PAGE	NAME NAME NOM	PAGE SEITE PAGE
CABUS	634-635	CAROVIGNO	682	CORTADERAS	384,765
CADAQUES	340	CARPENTO	324	CORTENOVA	374
CADAQUES 1	340	CARTAMA	371	COSSANO	205-207
CADEGAL	588-589	CARTIGNANO	568	COSSANO 2	208
CAGUANES	430	CASIBARE	234-235,678	COSWARTH	680
CAHUAMA	784	CASIBARE-QI	805	COTORRO	667
CAJERO	820-821	CASTELLATO	790	CREMELLA	236-237
CALAGRANO	541	CASTRALVO	432	CUMIOLE	382
CALAGRANO-Z	37	CAUPO	808	CURASAO	408
CALMANERA	410-411	CAYUCA	717	DAKAR 1	702-703
CALNOVA	635	CEPPINO	814	DAKAR 3	754
CAMACHO	222-223	CERASELLA	355	DAMASCO 1	793-794
CAMASCA	415	CHIETINO 1	780	DAMBERA	816
CAMASTRA	418	CIGLIE	567	DARNIUS	768
CAMBAITO	414	CIVITATE	569	DAVIDA	720-721
CAMBULOS	394	CLAVELLINA	288-289	DAVIDA 1	722-723
CAMINALES-Z	46	CLEMENTE	363,496	DESIERTO	797
CAMPANIA	562	CODRIALES	296-297	DUNDRY	840-841
CAMPILO	424	COGNOLI	810	DURELO	545
CANICOSA 2	504	COLTI	562	DURENGO	816
CANTALLOPS	419	COMPETA 1	527-528	ELGVERO	587
CANTERRAS	230-231	CONCESSA 1	182-183	ELIZONDO	582
CAPASSO	530	CONDRADA 1	494	ELLA	544
CAPASSO 1	518	CONESA	762	ENALURI	370
CAPASSO-Z	55	CONESSA	368-369	ENCINITOS	409,477
CARANACOA	292-293	CONNECT Z	21	ENEA	704-705
CARBONERAS	767	CONNECT-Z SENSOR	21	ERMUA	395,787
CARDILLIO 1	744-745,747	CONSACA	676	ERSEKA	250-251
CARDILLIO 2	746-747	CONTRISA	434	ERVIDEL	286-287
CARDITO	497	CORBERA	728	ESCANDIDOS	244-245
CARDITO 1	364	CORETTO	357	ESPARTAL	763
CARLTON 2	778	CORREDERA	398	ESTAZIONA	761

NAME NAME NOM	PAGE SEITE PAGE	NAME NAME NOM	PAGE SEITE PAGE	NAME NAME NOM	PAGE SEITE PAGE
ESTEPERRA	152,155,669	GERBERA 1	562	LAZOLO	442
ESTEVAU	401	GEXO	818	LEBALIO	333
EXTENTION	845	GIRON	506	LED CARPI	616-617
FABIO	752	GIRON-S	507	LED PALERMO	615
FALICETTO	582	GITA 2	638	LED STRIPE-Z	84-85
FARSALA	345	GOROSIBA	262-263	LEJIAS	300-301
FEDRA 2	365	GOROSIBA 1	262	LIBERTAD	218,220
FELONICHE	575	GRADOLI	380	LIBERTAD 1	219
FERENTINO	522-523	GRADOLI 1	381	LISCIANA	397
FILAGO	430,493	GRAFIK	556	LM_LED_E14	87
FIRMO	827	GUANAL	584	LM_LED_E27	86-97
FLORESTA	406	GURARE	571	LM_LED_GU10	87
FONDACHELLI	760	HAYES	583	LOBATIA	387
FOX	830	HERRORA-Z	60	LOBINERO-Z	26
FRADELO	500-502	IMPERIAL	560	LOCANDA	714
FRADELO 1	498-499	IPOSITTO	464	LOMALTAS-Z	48
FRAIOLI-Z	50-51	ISIDRO	290-291	LONCINO 1	359
FRANIA	508-509,512-513,610,612	JUAREZA-Z	49	LORD 2	444
FRANIA-A	106-107	JUNIOR 1	836	LORETO	491
FRANIA-S	510-511,514-515,611	KOB LED	843	LORETO 1	491
FUEVA 5	618-624,626	LA SECA	807	LOSALOMAS	413
FUEVA-A	112	LACEY-QI	805	LUBERIO	366
FUEVA-Z	68-79	LAGUNITAS	354	LUPPINERIA	539
GAETANO 1	436,438	LANCIANO	520-521	LURONE	246-247
GAFARES	462-463	LANCIANO 1	520-521	MACCACARI	574
GASCUERIA	582	LANCIANO-Z	54	MACCHIONE	481
GATUELA	391	LAROA	812-813	MAGITTA 1	554
GATUELA 1	390	LASANA	306	MAGNUM LED	741
GAZZOLA	416	LASANA 1	302,307	MAGNUM-LED	740-741
GEMILIANA	632	LASANA 2	302-303	MANALBA	781
GENOVESE-Z	33	LASANA 3	304-305	MANALBA 1	781
GEO	795	LAURITO	536	MANILVA 1	612

NAME NAME NOM	PAGE SEITE PAGE	NAME NAME NOM	PAGE SEITE PAGE	NAME NAME NOM	PAGE SEITE PAGE
MANIZALES	381	MIRTAZZA	400	OBREGON	425
MANTUNALLE	348,790	MOGANO	484-485	OILELLA	330-331
MANTUNALLE 1	347	MOGANO 1	438	OKINZURI	401
MANZANARES	252-253	MOGANO 2	487	OLIVAL 1	791
MARASALES	158,160	MONGODIO 1	586	ONEDA	764
MARBELLA	284-285	MONIROTE	457,459	ONO 2	573
MARGHERA-Z	44-45	MONTEBALDO	383,478	OPTICA	258-260
MARGITTA 1	551	MONTEFINO	372	PADROGIANO-Z	38-40
MARIEL	434,493	MONTEFIO	442	PADULARI	460
MARINELLO	467	MONTEFIO 1	366-367	PALBIETA	392
MARINELLO 1	466	MONTEMORELOS-Z	32-33	PALERMO 2	529
MARMORATA	473	MONTENOVO	505	PALMERA	650
MAROJALES	493	MORATICA-A	107	PALMITAL	608-609
MARONDA	191	MORDAZO	479	PALOMARO	128-129
MARS	553,558	MOSIANO	609	PALOMARO 1	128-129
MARS 1	552-553	MULEGES	407	PALOZZA	314-315
MARYVILLA	334,788	MURCIA	280-281	PALOZZA 1	312
MASERLO	166-167,172-174,176-181	MURMILLO	344	PANAGRIA	228-229
MASERLO 1	169-170	MURNIA	786	PANDELLA 1	644-647
MASERLO 2	166,174,177,180	MUSARA	475	PANDELLA 2	644,648
MASETA	404-405	MUSURITA	534-535	PARANDAY-Z	36-37
MASSERIE	802	NADINA	763	PARRAPOS-Z	34-35
MENTALURGIA	542	NARANJO	797	PASCAL 1	561
MESSINARO	476	NARICES	248-249	PASSA	578-581
MESTRE	560-561	NASTASIA	188	PASTERI	122-125,132-139,141-147,777
METRASS	590	NEMO	556	PASTERI SQUARE	126-127
METRASS 1	593	NEVADO	311	PASTORE	130
METRASS 2	591	NIEVES	533	PASTORE 1	130
MEZZANA	378	NIEVES 1	532	PASTORE 2	131
MINI 4	754-755	NOCITO	708-709	PEDREGAL 1	779
MIOGLIA 1	368	NOSINO	761	PENJAMO	540
MIRLAS	468	NUVANO	436-437	PERPIGO	392

NAME NAME NOM	PAGE SEITE PAGE	NAME NAME NOM	PAGE SEITE PAGE	NAME NAME NOM	PAGE SEITE PAGE
PESCAITO	534	ROMAO 3	121	SARRIA	724-727
PETTO 1	787	ROMAO-Z	30-31	SARRIONE	774
PICACHA	767	ROMAZZINA	238-241	SARSINA-A	108
PIEDRITAS	482	ROMENDO 1	628-629	SAVATARILA-Z	56-57
PINETTO	614-615	RONCADE	309,313	SAVOY	282-283
PINTO	272-273	RONCADE 1	308	SCALEA 1	554
PINTO GOLD	270-271	RONDO	254-256	SEGEZIA	416-417
PINTO NERO	268	RONDO 3	256	SELLANO	806
PINTO TEXTIL	266-267	ROTTELO	732-733	SELUCI	536-537
PINTO TEXTIL 1	264	ROVIRA	391	SELVINA	309-310,312
PLANET	546	ROVITO-Z	80-83	SELVINA 1	308
PLANET 1	546-549	RUEDA	846	SELVINO	350-351
POLLICA	672	RUFFO	837	SENDERO	210-211
POSADERRA	126	RUIDERA	517	SERAS	696-697,700-701
POZONDON	505	RUOTALE	397,460	SERAS 1	694-695
POZUETA	377	RUSTICARIA	199	SERAS 2	698-699
RAMON	419	SABINAR	426-427,429	SIBERIA	298-299
RAYA	554	SALICETO-Z	47	SIDERNO	630
RAZONI	402-403	SALITERAS-Z	57	SILENTINA	480-481
REDUCTA 2	543	SALITRE	398	SILERAS	516-517
REKALDE	764	SALOBRENA-A	110-111	SILERAS-A	105
REMIDOS	589	SALOBRENA-Z	64-67	SILERAS-Z	55
RENDE	531	SALOME	558-559	SILVARES	388
RICCIO 1	753	SALTO	748-749	SIMOLARIS-Z	42-43
RIVATO	276-277	SALVILANAS-Z	24-25	SLIM	793
ROCAMAR	356,358	SAMBATELLO	684-685,687	SNAPORA	816
ROCAMAR 1	357-358	SAN PERI	564	SOLO	793
ROCCAFORTE	420-423	SAN PERI 1	601	SOLO 1	792
ROLIMARE	461	SANIA 4	576-577	SOLO 2	791
ROMAGNESE	360	SANIA 5	630-631	SOREGO	718
ROMAO	120-121	SARGINTO	594-595	SORRENTA 1	503
ROMAO 1	120	SARONA	386,788	SPADAFORA	394,464

NAME NAME NOM	PAGE SEITE PAGE	NAME NAME NOM	PAGE SEITE PAGE	NAME NAME NOM	PAGE SEITE PAGE
STAITI	479	TRAGACETE 1	636-637	VILLABATE	671
STAITI 1	564	TREMEDAL	475	VILLABATE 1	776-777
STELLATO 1	200-201	TRONDIO	783	VINCHIO	648
STELLATO 2	201-202	TROY 3	274-275	VINOVO	280
STELLATO 3	203	TRUNCA	802	VISERBELLA	148-150
STICKER	651	TUKON 3	730	VOLTAGO 2	518
SWARBY	785	TURCONA-Z	58,62-63	WASAO 1	609
TABARA	836	TURIALDO	216	ZAMPOTE	465
TABIANO	641	TURIALDO 1	785	ZAMUDILO	516
TABIANO-Z	49	ULISANO	460	ZAPATA	693
TABILLANO	688	UP 2	770-771	ZAPATA 1	690
TABILLANO 1	822	VADUMI	642	ZARAGOZA	162-163
TAMARA 1	602-603	VALBIANO	670	ZERACO	731
TAMURIA	470	VALCASOTTO	488,538	ZILLERIO-Z	26
TANURA	584	VALCASOTTO 1	489	ZINACUA	571
TARANDELL	307	VALDELAGRANO-Z	42	ZOCABON	406
TAREGA	389,783	VALDIOLA	412	ZOLA	650
TARRAFO	431,489	VALLASPRA	361	ZUBIALDE	572-573
TAZZOLI	567	VALLEMARE	503	ZUBIETA-A	102-104
TELIBELA-Z	28-29	VALMORA	310-311		
TEYA	842	VARILLAS	157		
TIMPAROSSA	570	VARRAZO	365		
TINDORI	204-205	VELASCO	196-197		
TINEO	753	VENEZUELA	242-243		
TIRRENARA	466	VERADAL	814-815		
TOLLOS-Z	30	VERADAL-QI	805		
TOLORICO	606	VERDELLO	632-633		
TORONA 1	822	VERGIANO	719		
TORRETTA	635	VETRO	446-447		
TORRONTES	340	VIGLIONI	431		
TOTARI-Z	33,52-53	VIKI 1	837		
TOWNSHEND 3	660-663	VILANOVA	742-743		

REGISTER

ARTICLE NUMBER
ARTIKELNUMMER
NUMÉROS D'ARTICLE

NUMBER NUMMER NUMÉRO	PAGE SEITE PAGE	NUMBER NUMMER NUMÉRO	PAGE SEITE PAGE	NUMBER NUMMER NUMÉRO	PAGE SEITE PAGE	NUMBER NUMMER NUMÉRO	PAGE SEITE PAGE	NUMBER NUMMER NUMÉRO	PAGE SEITE PAGE	NUMBER NUMMER NUMÉRO	PAGE SEITE PAGE
12221	92	12257	96	31581	132	31667	365	33682	616	81636	544
12222	92	12258	97	31582	136	31995	309	33941	588	81827	795
12223	92	3041	446	31586	136	31996	309	33942	589	81828	795
12224	93	30658	588	31588	143	31997	313	33964	589	82305	793
12225	93	30659	588	31589	132	32025	497	33984	262	82741	560
12226	88	30832	722	31592	136	32048	306	39092	322	82747	283
12227	88	30833	723	31594	145	32428	736	39093	323	82748	282
12228	88	30834	723	31595	135	32429	736	39094	323	82749	282
12229	89	30835	723	31596	139	32431	736	39095	322	82751	283
12231	89	30931	494	31599	173	32432	737	39099	320	82752	283
12232	89	30933	494	31601	166	32433	737	39101	320	82785	446
12233	90	31001	710	31602	177	32765	690	39102	321	82786	446
12234	90	31002	711	31603	179	32766	690	39103	320	82842	770
12235	90	31003	710	31605	173	32767	690	39113	324	82843	770
12236	91	31004	710	31606	166	33168	661	39114	324	82844	771
12237	91	31005	712	31607	176	33169	660	39836	294	82942	546
12239	91	31006	713	31608	180	33171	660	39838	294	83119	556
12241	94	31007	713	31611	172	33172	660	39839	295	83132	556
12242	94	31008	713	31613	177	33184	738	43637	485	83153	547
12243	94	31571	143	31614	179	33185	738	7184	558	83154	547
12244	95	31572	132	31616	172	33186	738	7186	558	83155	546
12245	95	31573	137	31618	176	33187	739	7188	559	83156	547
12251	87	31574	141	31619	179	33199	102	80263	553	83157	548
12252	87	31575	142	31627	174	33344	422	80264	553	83159	548
12253	86	31576	133	31628	167	33345	420	80265	558	83162	548
12254	87	31577	137	31629	178	3355	445	81262	752	83163	549
12255	96	31578	141	31631	180	33677	603	81265	752	83404	544
12256	96	31579	142	31666	441	33678	603	81635	544	83406	650

NUMBER NUMMER NUMÉRO	PAGE SEITE PAGE	NUMBER NUMMER NUMÉRO	PAGE SEITE PAGE	NUMBER NUMMER NUMÉRO	PAGE SEITE PAGE	NUMBER NUMMER NUMÉRO	PAGE SEITE PAGE	NUMBER NUMMER NUMÉRO	PAGE SEITE PAGE	NUMBER NUMMER NUMÉRO	PAGE SEITE PAGE
84028	556	87055	441	900022	57	900079	50	900128	55	900172	701
85104	792	87219	650	900023	57	900081	50	900129	55	900173	700
85261	254	87222	650	900024	57	900082	50	900134	765	900174	397
85262	254	87254	792	900025	56	900083	54	900135	765	900175	397
85263	255	87256	792	900044	64	900084	52	900141	791	900176	247
85264	255	87284	836	900045	64	900085	53	900142	791	900177	246
85832	651	87793	561	900046	64	900086	80	900143	414	900178	247
85856	284	88472	702	900047	65	900087	81	900144	162	900179	247
85857	284	88473	702	900048	65	900088	80	900145	162	900185	493
85858	285	88474	703	900049	66	900089	80	900146	162	900186	430
85859	284	88475	703	900051	66	900091	83	900147	163	900187	760
85971	774	88968	845	900052	66	900092	82	900148	163	900188	491
85974	774	88969	845	900053	67	900093	82	900149	530	900195	332
85977	274	89115	561	900054	58	900094	82	900151	196	900196	332
85978	274	89238	553	900055	58	900095	67	900152	196	900302	478
85979	274	89239	552	900056	58	900099	68	900153	196	900304	253
85981	275	89248	552	900057	62	900101	68	900154	197	900305	252
85982	275	89758	554	900058	62	900102	68	900157	491	900306	253
86712	560	89832	272	900059	62	900103	74	900158	415	900307	253
86715	561	89833	273	900061	63	900104	74	900159	415	900313	432
86811	258	89834	272	900062	63	900105	72	900161	426	900314	786
86812	258	89835	272	900067	44	900106	72	900162	426	900315	36
86813	260	89836	273	900068	44	900107	73	900163	426	900316	36
86814	260	900001	52	900069	44	900108	78	900164	236	900317	36
86815	260	900002	52	900071	45	900109	79	900165	242	900318	37
86816	258	900005	54	900072	45	900111	70	900166	242	900319	35
86817	259	900006	54	900075	42	900112	70	900167	242	900321	35
87008	444	900008	55	900076	51	900113	70	900168	243	900322	34
87009	444	900019	49	900077	51	900114	76	900169	700	900323	34
87054	442	900021	49	900078	51	900115	76	900171	700	900324	34

NUMBER NUMMER NUMÉRO	PAGE SEITE PAGE	NUMBER NUMMER NUMÉRO	PAGE SEITE PAGE	NUMBER NUMMER NUMÉRO	PAGE SEITE PAGE	NUMBER NUMMER NUMÉRO	PAGE SEITE PAGE	NUMBER NUMMER NUMÉRO	PAGE SEITE PAGE	NUMBER NUMMER NUMÉRO	PAGE SEITE PAGE
900325	573	900363	611	900404	27	900446	430	900495	238	900529	809
900328	465	900364	611	900406	30	900463	539	900496	240	900549	334
900329	465	900365	615	900407	30	900464	539	900497	241	900551	334
900331	718	900366	614	900408	32	900465	298	900498	532	900552	788
900332	718	900367	476	900409	32	900466	298	900499	532	900553	487
900333	718	900369	617	900411	32	900467	298	900501	532	900554	487
900334	785	900375	583	900412	33	900468	299	900502	198	900555	487
900335	530	900376	189	900419	461	900469	299	900503	198	900558	473
900336	28	900377	189	900421	462	900471	460	900504	198	900559	473
900337	28	900378	189	900422	463	900472	397	900505	199	900561	473
900338	28	900379	434	900423	463	900475	632	900506	335	900562	293
900339	29	900381	434	900424	463	900476	633	900507	335	900563	292
900341	264	900382	687	900425	414	900477	33	900508	335	900564	293
900342	264	900383	687	900426	414	900478	26	900509	481	900565	293
900343	584	900384	687	900428	601	900479	26	900511	256	900566	37
900346	416	900385	199	900429	412	90048	278	900512	256	900567	37
900347	188	900386	199	90043	554	900481	38	900513	746	900571	472
900348	188	900387	22	900431	412	900482	40	900514	747	900572	472
900349	219	900388	22	900432	667	900483	38	900515	747	900573	472
900351	288	900391	22	900433	667	900484	38	900516	746	900596	460
900352	288	900392	23	900434	667	900485	40	900517	584	900597	460
900353	288	900393	764	900435	489	900486	39	900518	584	900598	521
900354	289	900394	764	900436	717	900487	39	900519	238	900599	521
900355	482	900395	256	900437	717	900488	228	900521	241	900601	541
900356	482	900396	787	900438	717	900489	228	900522	239	900602	541
900357	482	900398	26	900439	30	90049	278	900523	241	900603	466
900358	790	900399	382	900441	31	900491	228	900524	479	900604	466
900359	484	900401	386	900442	31	900492	229	900525	570	900605	524
900361	493	900402	386	900443	489	900493	229	900526	570	900606	524
900362	434	900403	788	900444	431	900494	238	900528	809	900607	522

NUMBER NUMMER NUMÉRO	PAGE SEITE PAGE	NUMBER NUMMER NUMÉRO	PAGE SEITE PAGE	NUMBER NUMMER NUMÉRO	PAGE SEITE PAGE	NUMBER NUMMER NUMÉRO	PAGE SEITE PAGE	NUMBER NUMMER NUMÉRO	PAGE SEITE PAGE	NUMBER NUMMER NUMÉRO	PAGE SEITE PAGE
900608	522	90917	733	92288	845	93046	783	93877	772	94592	358
900609	523	90927	733	9229	828	93073	366	93901	806	94593	358
900611	523	90967	826	9230	829	93076	818	93917	770	94605	438
900612	531	90977	828	9232	829	93077	818	93949	129	94606	438
900613	531	90978	445	92348	846	93078	816	93952	129	94609	742
900614	491	90982	705	92563	279	93085	742	93965	808	94612	641
900615	632	90984	704	92595	734	93092	365	93966	808	94613	641
900616	632	90985	704	92596	734	93358	743	94145	730	94614	641
900617	633	90986	704	92597	734	93359	742	94146	730	94617	635
900618	633	91002	280	92598	735	93373	424	94244	371	94626	609
900619	611	91004	280	92599	735	93374	424	94245	371	94635	206
900626	805	91005	281	92641	740	93395	128	94251	714	94636	206
900628	805	91006	281	92642	740	93397	128	94252	714	94673	816
900631	296	91238	793	92643	740	93468	442	94319	360	94677	816
900632	296	91242	795	92644	741	93625	364	94329	753	94686	843
900633	297	91433	280	92645	741	93626	364	94377	359	94697	824
900634	164	91496	442	92727	494	93672	728	94378	359	94698	769
900635	164	91589	255	92739	276	93673	728	94388	403	94699	824
900636	33	91971	279	92741	277	93674	728	94389	403	94702	824
900839	747	92084	720	92742	277	93679	731	94438	205	94704	825
90304	268	92085	720	92743	277	93706	843	94442	205	94705	769
90305	268	92086	720	92761	362	93707	843	94513	787	94712	638
90697	562	92087	721	92762	362	93708	367	94547	484	94713	638
90737	562	92143	562	92872	830	93709	366	94548	484	94714	638
90872	827	92146	837	92873	830	93713	774	94584	707	94716	635
90873	827	92147	837	92924	754	93784	367	94585	706	94764	207
90874	827	92206	763	92925	754	93836	357	94586	706	94765	207
90914	732	92251	402	92933	755	93874	773	94587	706	94767	207
90915	732	92252	403	92935	754	93875	772	94589	356	94878	604
90916	732	9228	828	93003	273	93876	772	94591	356	94879	604

NUMBER NUMMER NUMÉRO	PAGE SEITE PAGE	NUMBER NUMMER NUMÉRO	PAGE SEITE PAGE	NUMBER NUMMER NUMÉRO	PAGE SEITE PAGE	NUMBER NUMMER NUMÉRO	PAGE SEITE PAGE	NUMBER NUMMER NUMÉRO	PAGE SEITE PAGE	NUMBER NUMMER NUMÉRO	PAGE SEITE PAGE
94884	609	95147	306	95483	708	95632	749	95912	369	96104	302
94918	143	95164	145	95484	709	95639	497	95913	368	96105	303
94919	134	95166	139	95485	708	95655	500	95914	369	96106	303
94921	137	95167	135	95522	388	95656	500	95972	518	96111	551
94924	144	95169	174	95523	388	95657	501	95973	518	96117	551
94925	134	95171	178	95525	389	95658	501	95993	602	96178	744
94926	138	95172	181	95526	389	95659	501	95994	602	96179	744
94935	436	95173	167	95527	783	95661	500	95995	602	96181	745
94936	436	95185	779	95539	760	95662	502	96023	530	96182	744
94938	438	95192	191	95541	760	95664	502	96026	518	96183	745
94958	725	95194	191	95545	693	95672	554	96032	528	96193	210
94959	725	95254	208	95546	693	95677	527	96033	528	96194	210
94961	725	95257	208	95547	693	95679	527	96034	528	96195	210
94962	724	95261	208	95567	307	95682	529	96037	590	96199	211
94963	726	95282	616	95568	307	95684	529	96038	590	96201	211
94964	726	95283	617	95569	302	95686	762	96039	593	96211	204
94965	727	95284	496	95589	203	95689	503	96041	593	96214	205
94966	726	95285	496	95591	203	95694	821	96042	591	96229	612
94967	616	95286	363	95594	203	95695	820	96043	591	96231	612
94973	545	95287	363	95597	201	95696	820	96048	573	96257	204
94987	651	95364	580	95598	200	95725	777	96049	573	96258	204
94995	191	95368	579	95599	200	95726	777	96064	646	96261	578
94998	615	95371	580	95602	200	95755	436	96065	646	96264	579
94999	615	95373	581	95605	202	95775	794	96066	646	96305	311
95044	146	95377	579	95606	201	95776	794	96072	447	96306	312
95045	146	95379	580	95607	201	95785	793	96073	447	96308	310
95055	178	95383	425	95609	202	95787	778	96081	842	96326	310
95118	144	95385	425	95628	749	95788	778	96089	551	96327	310
95119	139	95386	781	95629	748	95789	778	96102	302	96329	309
95122	135	95482	708	95631	749	95824	741	96103	303	96331	311

NUMBER NUMMER NUMÉRO	PAGE SEITE PAGE	NUMBER NUMMER NUMÉRO	PAGE SEITE PAGE	NUMBER NUMMER NUMÉRO	PAGE SEITE PAGE	NUMBER NUMMER NUMÉRO	PAGE SEITE PAGE	NUMBER NUMMER NUMÉRO	PAGE SEITE PAGE	NUMBER NUMMER NUMÉRO	PAGE SEITE PAGE
96332	311	96773	344	97367	372	97605	384	97718	630	97876	512
96343	345	96774	344	97368	372	97606	384	97719	630	97877	510
96344	345	96866	307	97479	130	97611	122	97731	478	97878	510
96345	345	96937	635	97487	503	97612	125	97733	383	97879	510
96434	812	96938	634	97506	719	97613	123	97734	383	97881	514
96435	813	96957	822	97507	719	97614	124	97737	521	97882	514
96436	813	96981	427	97508	719	97615	122	97738	520	97883	514
96437	812	96982	427	97516	780	97616	125	97773	782	97884	610
96438	812	96983	427	97526	506	97617	123	97774	782	97885	612
96439	813	96985	429	97527	506	97618	124	97777	120	97886	564
96474	447	96986	429	97528	506	97619	122	97778	121	97895	479
96477	144	97044	807	97531	610	97621	125	97779	120	97904	479
96478	134	97045	807	97536	670	97622	123	97782	120	97914	810
96479	138	97054	606	97537	670	97641	148	97783	121	97915	810
96481	141	97055	606	97538	670	97642	149	97784	121	97934	753
96483	147	97056	606	97541	507	97643	148	97793	361	97965	608
96484	147	97059	648	97542	507	97644	148	97806	765	97966	609
96528	360	97066	401	97543	507	97645	150	97838	130	98016	380
96538	128	97077	752	97571	841	97646	150	97839	270	98017	380
96539	129	97078	820	97572	840	97647	150	97841	420	98023	505
96541	628	97081	642	97573	840	97651	270	97845	420	98034	476
96542	628	97082	642	97574	840	97652	271	97846	421	98035	476
96543	629	97083	642	97575	837	97653	270	97854	423	98056	374
96544	628	97209	791	97577	516	97655	271	97855	423	98057	374
96552	696	97333	790	97578	517	97667	836	97857	423	98058	374
96553	697	97361	314	97583	768	97682	183	97871	508	98071	418
96554	697	97362	314	97584	768	97683	183	97872	508	98093	802
96555	697	97363	314	97587	361	97684	182	97873	508	98111	663
96566	567	97364	315	97589	785	97685	182	97874	512	98112	662
96567	567	97366	372	97604	384	97699	604	97875	512	98113	662

NUMBER NUMMER NUMÉRO	PAGE SEITE PAGE	NUMBER NUMMER NUMÉRO	PAGE SEITE PAGE	NUMBER NUMMER NUMÉRO	PAGE SEITE PAGE	NUMBER NUMMER NUMÉRO	PAGE SEITE PAGE	NUMBER NUMMER NUMÉRO	PAGE SEITE PAGE	NUMBER NUMMER NUMÉRO	PAGE SEITE PAGE
98114	662	98309	763	98409	130	98543	574	98651	342	98754	263
98134	684	98311	157	98421	576	98544	575	98652	342	98755	582
98135	684	98313	157	98422	576	98545	575	98653	343	98759	582
98136	685	98314	157	98423	576	98582	340	98654	343	98762	688
98137	684	98317	474	98424	577	98585	340	98656	586	98763	688
98139	671	98318	474	98425	577	98587	190	98657	586	98764	688
98141	671	98319	474	98426	577	98588	190	98661	377	98831	815
98201	111	98323	520	98446	509	98591	432	98662	377	98832	814
98203	111	98324	520	98447	513	98592	432	98663	377	98834	381
98205	110	98325	533	98448	511	98595	357	98674	764	98835	381
98206	110	98326	533	98449	515	98596	358	98676	587	98836	395
98207	108	98331	480	98456	419	98601	535	98677	645	98837	787
98208	108	98332	480	98458	768	98602	535	98678	370	98838	413
98209	108	98333	480	98487	505	98603	534	98679	475	98839	413
98212	112	98334	481	98488	505	98604	535	98682	392	98841	571
98219	107	98346	378	98491	464	98614	336	98683	392	98842	69
98227	105	98347	378	98492	394	98615	336	98685	504	98843	75
98228	105	98353	419	98494	464	98616	336	98687	391	98844	71
98235	107	98379	582	98495	394	98617	337	98688	401	98845	76
98236	106	98384	346	98501	648	98621	682	98689	401	98846	72
98237	106	98386	766	98502	648	98622	682	98694	350	98847	78
98247	802	98387	766	98507	475	98623	682	98695	350	98849	74
98263	567	98393	694	98514	493	98624	672	98696	350	98852	77
98277	846	98394	694	98523	352	98625	672	98697	351	98854	78
98279	846	98395	695	98524	352	98626	672	98698	351	98855	814
98291	340	98396	694	98525	353	98628	368	98699	351	98856	814
98292	112	98397	699	98526	352	98629	368	98734	440	98858	383
98293	112	98398	698	98527	504	98647	339	98735	440	98859	785
98294	106	98399	699	98541	574	98648	339	98752	263	98861	468
98297	110	98408	699	98542	574	98649	339	98753	263	98862	468

NUMBER NUMMER NUMÉRO	PAGE SEITE PAGE	NUMBER NUMMER NUMÉRO	PAGE SEITE PAGE	NUMBER NUMMER NUMÉRO	PAGE SEITE PAGE	NUMBER NUMMER NUMÉRO	PAGE SEITE PAGE	NUMBER NUMMER NUMÉRO	PAGE SEITE PAGE	NUMBER NUMMER NUMÉRO	PAGE SEITE PAGE
98863	468	99052	674	99113	766	99279	155	99339	637	99446	184
98864	788	99053	674	99122	600	99286	266	99341	516	99447	184
98874	286	99054	674	99123	600	99287	267	99342	516	99457	225
98875	286	99072	400	99124	600	99288	266	99343	525	99463	390
98876	286	99073	400	99202	618	99292	222	99344	525	99464	390
98877	287	99074	680	99203	618	99293	222	99345	236	99465	525
98878	287	99075	680	99204	621	99294	222	99346	236	99466	227
98881	477	99076	680	99205	620	99295	223	99347	237	99467	226
98882	477	99077	216	99206	618	99296	223	99348	564	99468	226
98887	794	99078	216	99207	619	99297	647	99353	225	99469	227
98888	590	99079	216	99208	620	99298	126	99356	497	99486	186
98889	312	99086	572	99209	620	99314	333	99358	296	99487	186
98891	104	99087	572	99211	623	99315	304	99366	348	99488	664
98892	104	99089	126	99212	622	99316	304	99367	348	99489	664
98893	104	99091	127	99213	622	99317	304	99368	348	99491	664
98894	102	99092	127	99214	622	99318	305	99369	790	99492	665
98895	102	99093	251	99249	398	99319	305	99371	347	99506	237
98896	103	99094	251	99265	624	99321	308	99372	347	99507	237
98907	644	99095	251	99266	624	99322	308	99395	461	99508	131
98908	644	99096	250	99267	624	99323	308	99397	542	99509	131
98909	378	99097	250	99268	626	99324	498	99398	542	99511	232
99013	392	99098	250	99269	626	99325	498	99399	543	99512	232
99015	761	99099	21	99271	626	99326	499	99406	534	99513	232
99019	822	99101	761	99272	152	99327	499	99407	534	99514	488
99041	170	99103	776	99273	152	99328	498	99408	225	99515	488
99042	169	99104	777	99274	152	99329	781	99413	224	99516	488
99043	169	99106	21	99275	155	99331	781	99429	294	99517	678
99044	169	99107	370	99276	669	99332	783	99438	416	99518	678
99045	170	99108	517	99277	669	99334	818	99439	417	99519	678
99046	170	99109	517	99278	669	99335	819	99445	184	99523	160

NUMBER NUMMER NUMÉRO	PAGE SEITE PAGE	NUMBER NUMMER NUMÉRO	PAGE SEITE PAGE	NUMBER NUMMER NUMÉRO	PAGE SEITE PAGE	NUMBER NUMMER NUMÉRO	PAGE SEITE PAGE	NUMBER NUMMER NUMÉRO	PAGE SEITE PAGE	NUMBER NUMMER NUMÉRO	PAGE SEITE PAGE
99524	158	99594	249	99631	262	99682	25	99774	652	99808	245
99525	158	99595	568	99632	262	99683	25	99776	636	99809	244
99526	160	99596	569	99633	405	99684	84	99777	636	99811	381
99527	160	99597	797	99634	404	99685	85	99778	636	99817	464
99531	387	99599	394	99635	404	99686	84	99779	536	99818	398
99532	387	99601	42	99636	404	99687	84	99781	537	99819	391
99539	174	99602	43	99639	60	99689	571	99782	536	99821	391
99541	177	99603	42	99651	354	99691	631	99783	536	99822	767
99542	180	99604	43	99654	354	99692	630	99784	458	99824	784
99543	166	99605	43	99655	470	99693	410	99785	458	99825	784
99544	230	99606	594	99656	470	99694	410	99786	458	99828	803
99545	230	99607	594	99659	467	99695	411	99787	457	99829	803
99546	231	99608	595	99661	408	99696	411	99788	456	99831	804
99547	231	99609	595	99662	408	99697	399	99789	457	99832	804
99548	60	99611	187	99663	437	99698	399	99791	459	99838	654
99549	60	99612	186	99664	477	99699	533	99792	457	99839	654
99551	234	99613	158	99665	409	99701	431	99793	466	99853	654
99552	234	99614	330	99666	409	99702	431	99794	797	99854	655
99553	234	99615	330	99667	490	99703	540	99795	218	99855	218
99554	235	99616	330	99669	47	99704	540	99796	220	99856	218
99555	235	99617	331	99671	47	99705	406	99797	220		
99559	312	99618	407	99672	47	99706	406	99798	220		
99561	291	99619	407	99673	46	99707	406	99799	300		
99562	290	99621	538	99674	46	99711	676	99801	300		
99563	291	99622	538	99675	46	99712	676	99802	300		
99564	291	99623	538	99676	48	99713	676	99803	301		
99588	49	99624	224	99677	48	99715	767	99804	301		
99591	249	99625	226	99678	24	99731	644	99805	301		
99592	248	99628	355	99679	24	99772	652	99806	244		
99593	249	99629	355	99681	24	99773	652	99807	244		



All previous catalogues and price lists are no longer valid with the issue of this catalogue. Errors, misprints, model and price changes and technical modifications are reserved. We deliver based on our terms of delivery and payment. Our products comply with the European light norm EN60598. Products with the ENEC test mark are conforming to the guide line 2006/95/EG. Products with additional safety remarks (e.g protection class, IP) are identified within the product family with the relevant symbol and number. The content of this catalogue is protected under copyright law for EGLO Leuchten GmbH. All rights reserved. Our specific written consent must be obtained before using any illustrations and texts. The pictures are 4C prints and may differ from the original. The product pictures and ambiances in this catalogue can deviate from reality, and they do not necessarily concur with the usual application of the product. EGLO does not assume liability for the correctness, completeness or the application depiction of the products and/or the product information. Design, layout and composition: EGLO GmbH, A-6136 Pill - AUSTRIA Print: Samson Druck GmbH, 5581 St. Margarethen - AUSTRIA Pictures: EGLO, Adobe Stock, istockphoto.com

Mit diesem Katalog verlieren alle vorhergehenden Kataloge und Preislisten ihre Gültigkeit. Irrtümer, Druckfehler, Modell- und Preisänderungen sowie technische Änderungen vorbehalten. Wir liefern zu unseren Liefer- und Zahlungsbedingungen. Unsere Produkte entsprechen der europäischen Leuchtnorm EN 60598. Produkte mit dem ENEC Prüfzeichen sind konform mit der Richtlinie 2006/95/EG. Produkte mit weiteren Sicherheitshinweisen (zB. Schutzklasse, IP) sind mit Symbol und Zahl bei der Produktfamilie ausgezeichnet. Der Inhalt dieses Kataloges ist für die EGLO Leuchten GmbH urheberrechtlich geschützt. Alle Rechte sind vorbehalten. Bilder und Texte dürfen nicht ohne vorherige ausdrückliche, schriftliche Genehmigung verwendet werden. Die Abbildungen sind 4C Drucke und können vom Original abweichen. Die Katalogbilder und die gezeigten Darstellungen der Produkte können von der Wirklichkeit abweichen und nicht den üblichen Produktanwendungen entsprechen. EGLO übernimmt keine Haftung für die Richtigkeit, Vollständigkeit und Anwendungsdarstellung der Produkte und Produktinformationen. Gestaltung, Layout und Satz: EGLO GmbH, A-6136 Pill - AUSTRIA Druck: Samson Druck GmbH, 5581 St. Margarethen - AUSTRIA Bilder: EGLO, Adobe Stock, istockphoto.com

Le présent catalogue remplace tous les catalogues et tarifs précédents. Sous réserve d'erreurs, de fautes d'impression, de modification des modèles et de changement de prix et de technique. Nous livrons sur la base de nos conditions de livraison et de paiement. Nos produits sont conformes aux normes européennes EN 60598 et portent le marquage CE. Les produits portant la marque ENEC sont conformes à la Directive 2006/95/EG. Les produits portant d'autres indications de sécurité (par exemple classe de protection, IP) sont identifiés par le symbole et le nombre correspondants dans la famille de produits. Le contenu du présent catalogue est protégé pour la société EGLO Leuchten GmbH par un copyright. Tous droits réservés. Toute reproduction d'images et du texte est interdite sans autorisation explicite par écrit préalable. Les images sont imprimées en 4C et peuvent différer de l'original. Les images des produits et les ambiances dans le catalogue peuvent dévier de la réalité et ne sont pas nécessairement en ligne avec l'usage habituel du produit. EGLO n'engage pas sa responsabilité sur la justesse des images et sur les informations relatives à l'usage pouvant être fait des produits. Conception, maquette et composition: EGLO GmbH, A-6136 Pill - AUSTRIA Presse: Samson Druck GmbH, 5581 St. Margarethen - AUSTRIA Images: EGLO, Adobe Stock, istockphoto.com

07-2022



EGLO
my light | my style

EGLO Leuchten GmbH
Heiligkreuz 22
A-6136 Pill
Austria
Tel. +43 (0) 5242 6996
Fax +43 (0) 5242 6996-972
info@eglo.com
www.eglo.com

KAT-22



my light | my style